



US00D376991S

United States Patent [19]

Freese et al.

[11] Patent Number: **Des. 376,991**

[45] Date of Patent: ****Dec. 31, 1996**

[54] **BABY MONITOR RECEIVER**

[75] Inventors: **Theodore B. Freese**, Westminster, Colo.; **Gregory S. Hinzmann**, Hillsboro; **Angelika I. Schubert**, Portland, both of Oreg.

[73] Assignee: **Gerry Baby Products Company**, Thornton, Colo.

[**] Term: **14 Years**

D. 340,928 11/1993 Knoedler et al. D14/159
 D. 344,907 3/1994 Abrams et al. D14/159
 D. 347,218 5/1994 Shuler D14/159

Primary Examiner—A. Hugo Word
Assistant Examiner—Marcus Jackson
Attorney, Agent, or Firm—Biebel & French

[57] CLAIM

The ornamental design for a baby monitor receiver, as shown and described.

[21] Appl. No.: **46,754**

[22] Filed: **Nov. 3, 1995**

[52] U.S. Cl. **D10/104**

[58] Field of Search D10/104, 106,
 D10/116, 121; D14/159, 191, 194; 340/345,
 348, 349, 351, 354, 371, 372, 373, 571,
 572, 573

DESCRIPTION

FIG. 1 is a perspective view of a baby monitor receiver illustrating the present invention;
 FIG. 2 is a top plan view thereof;
 FIG. 3 is a front elevational view thereof;
 FIG. 4 is a rear elevational view thereof;
 FIG. 5 is a left side elevational view thereof;
 FIG. 6 is a right side elevational view thereof; and,
 FIG. 7 is a bottom plan view thereof.

[56] References Cited

U.S. PATENT DOCUMENTS

D. 312,222 11/1990 Sawyer D10/106

1 Claim, 4 Drawing Sheets

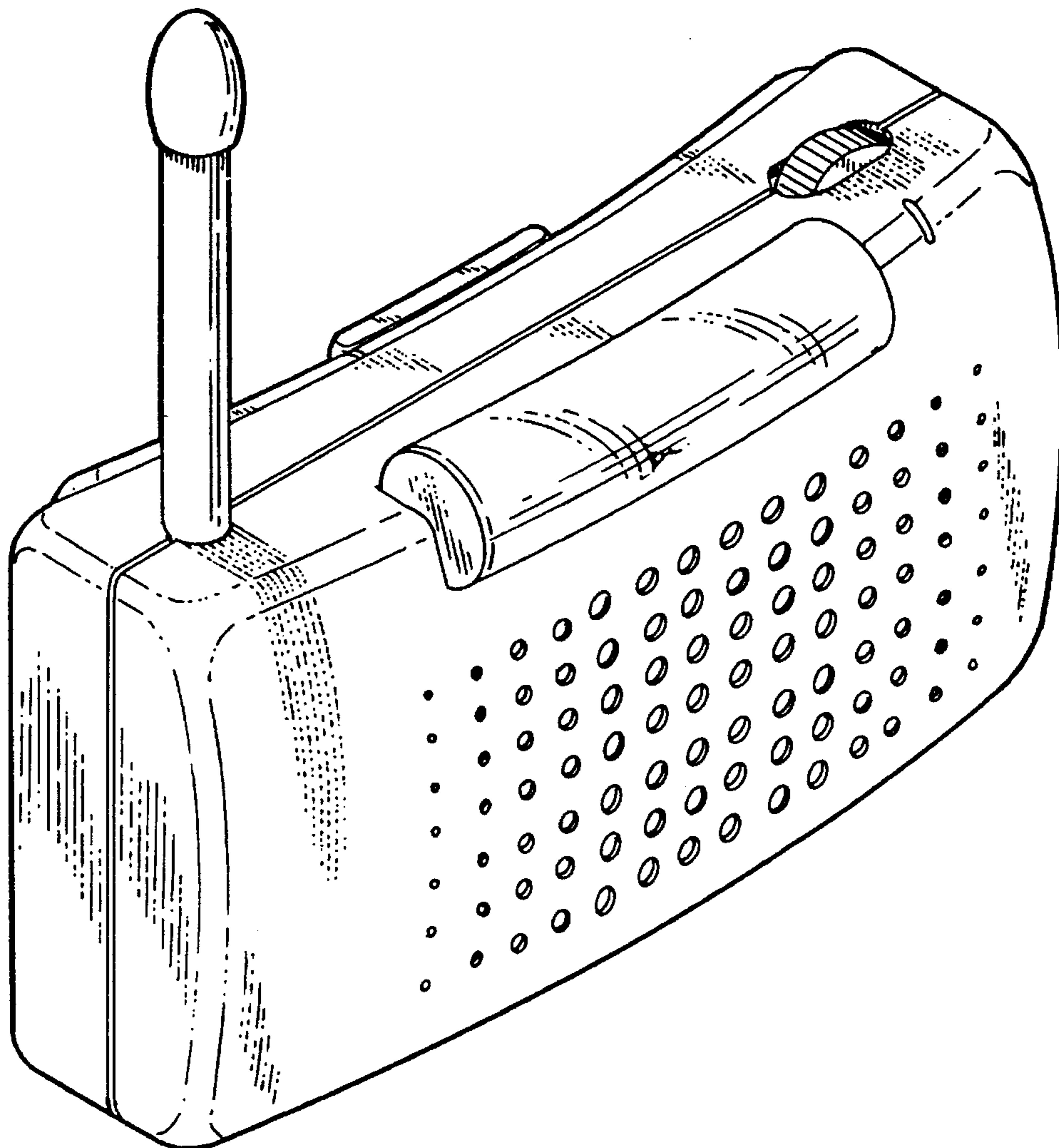

FIG -1

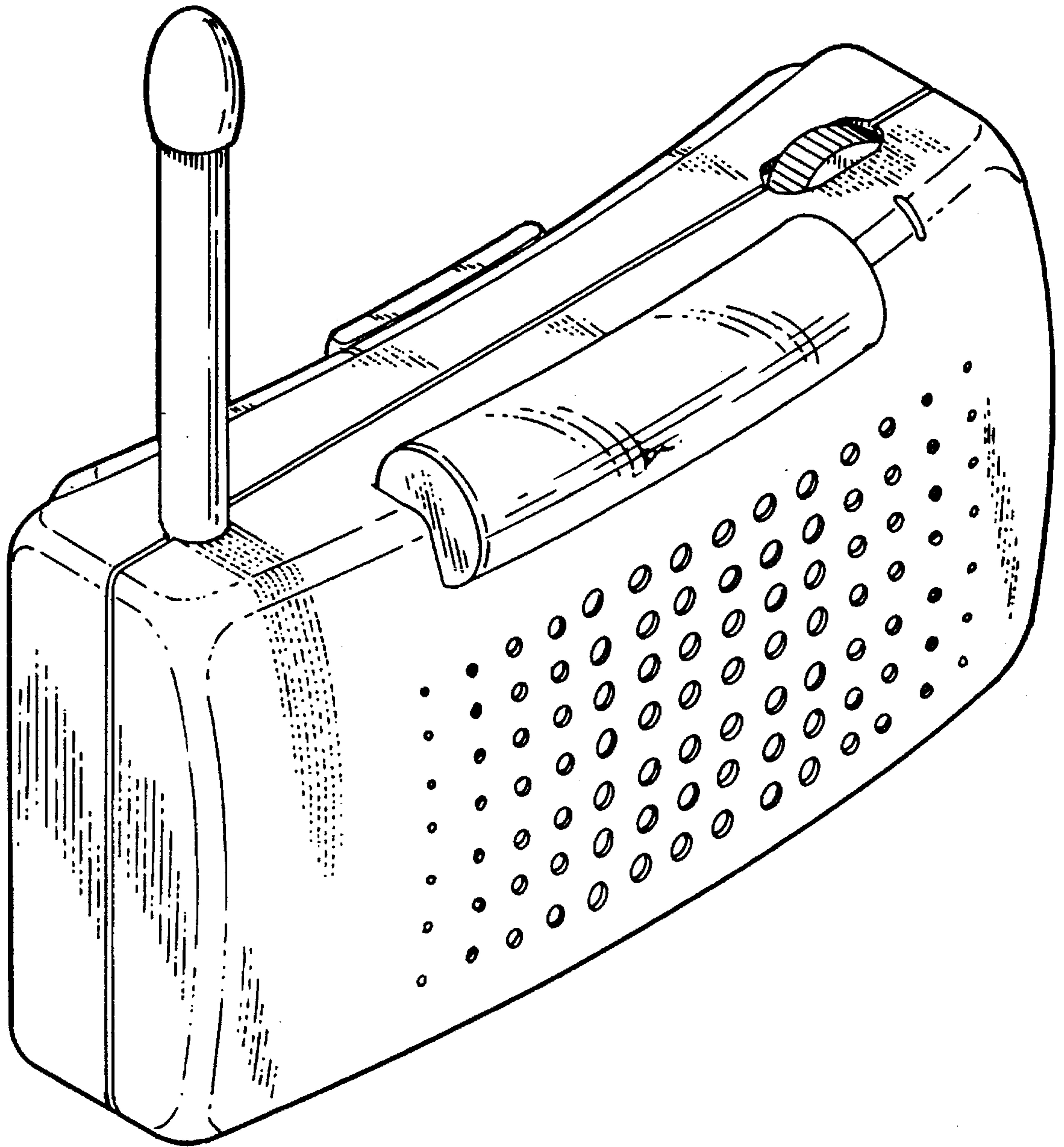

FIG-2

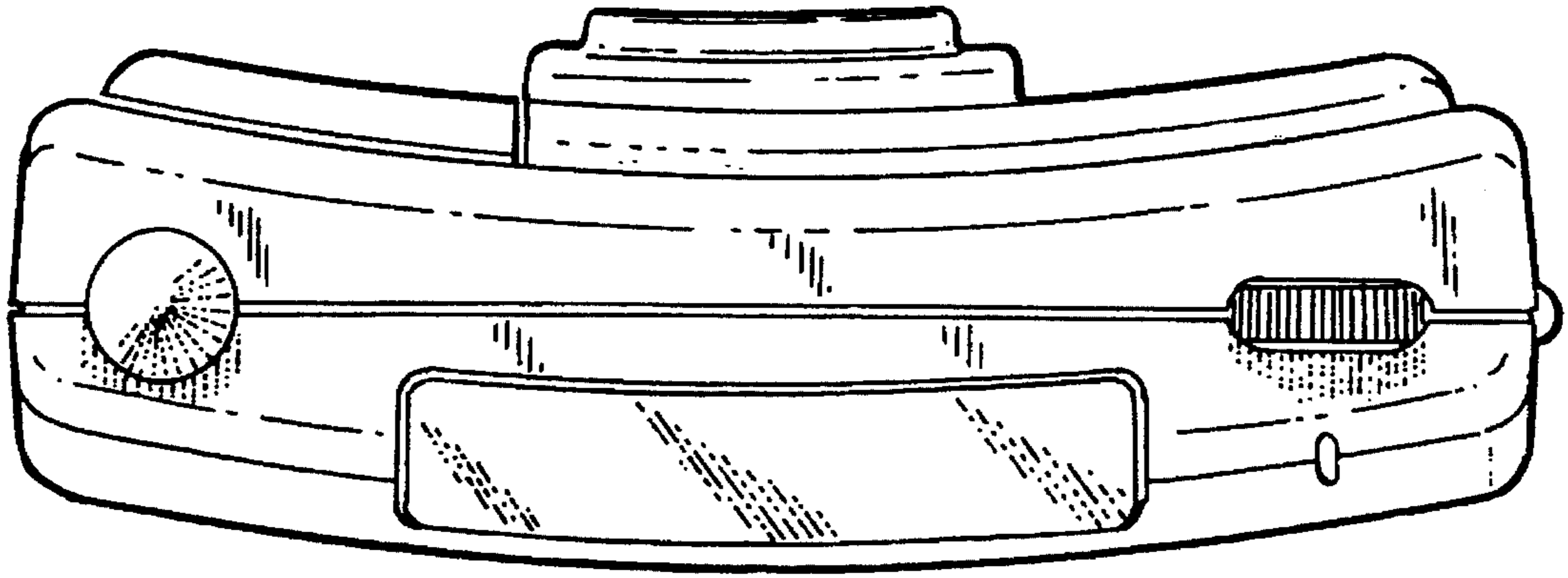
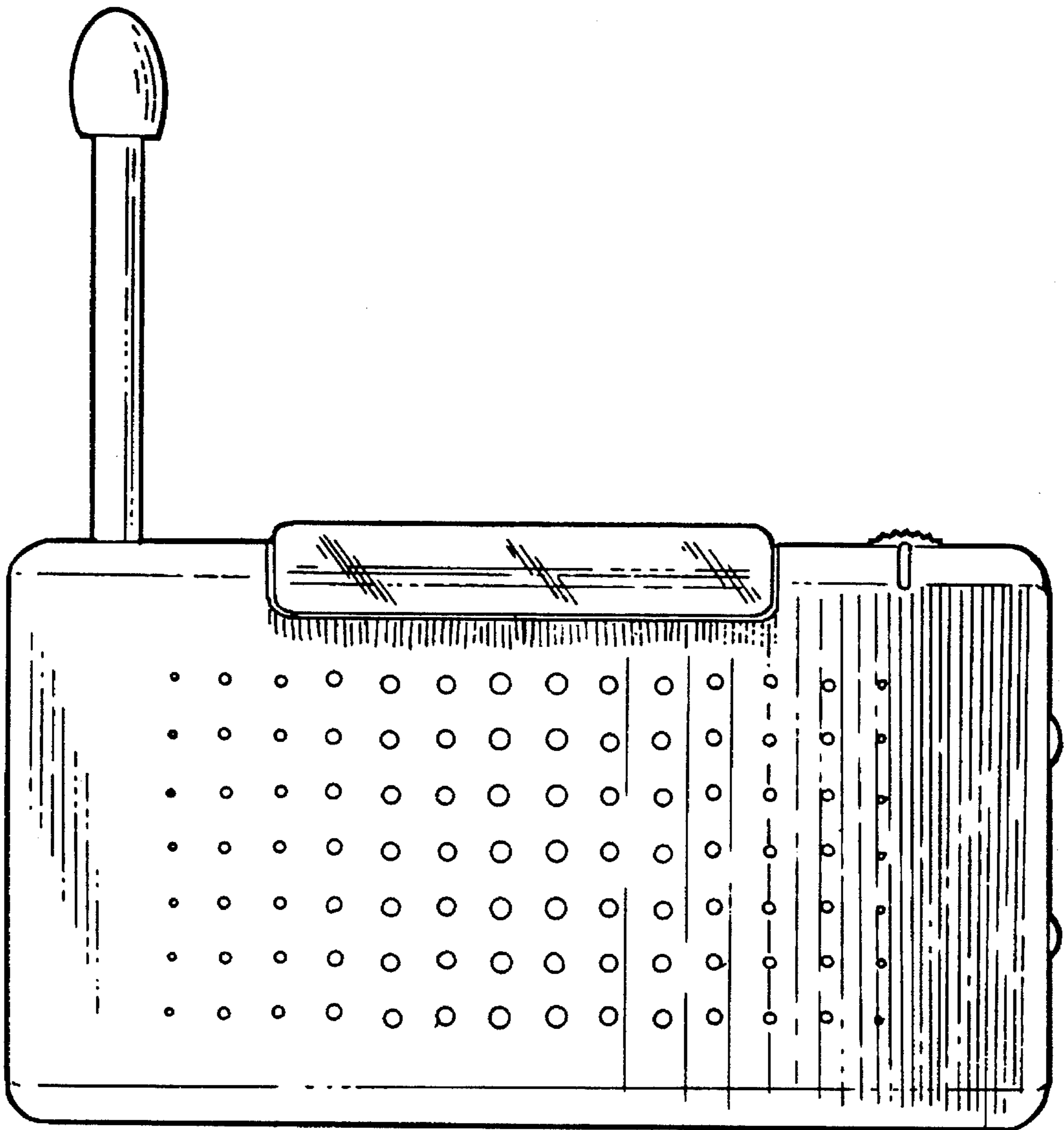

FIG-3



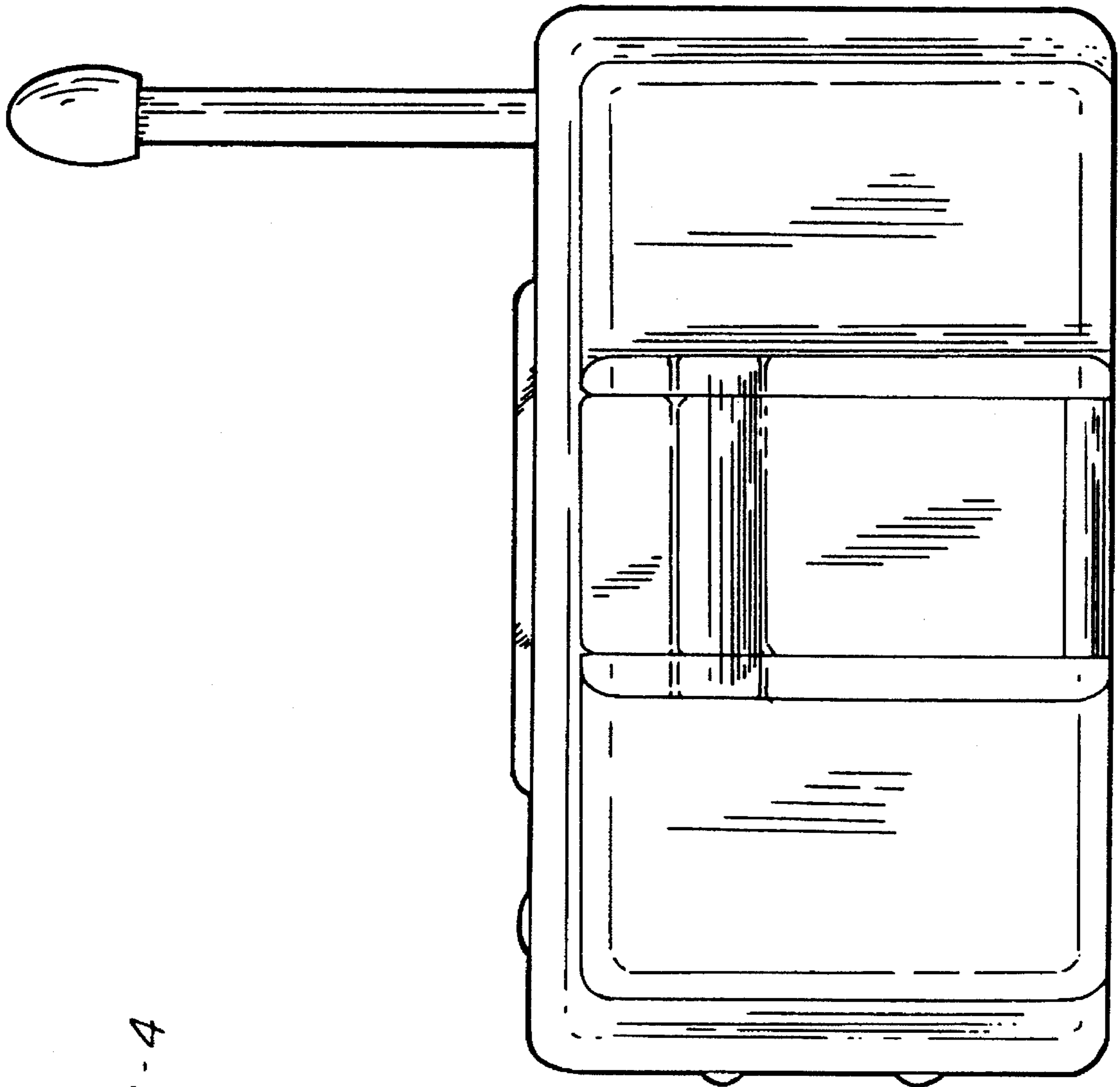

FIG-4

FIG - 5

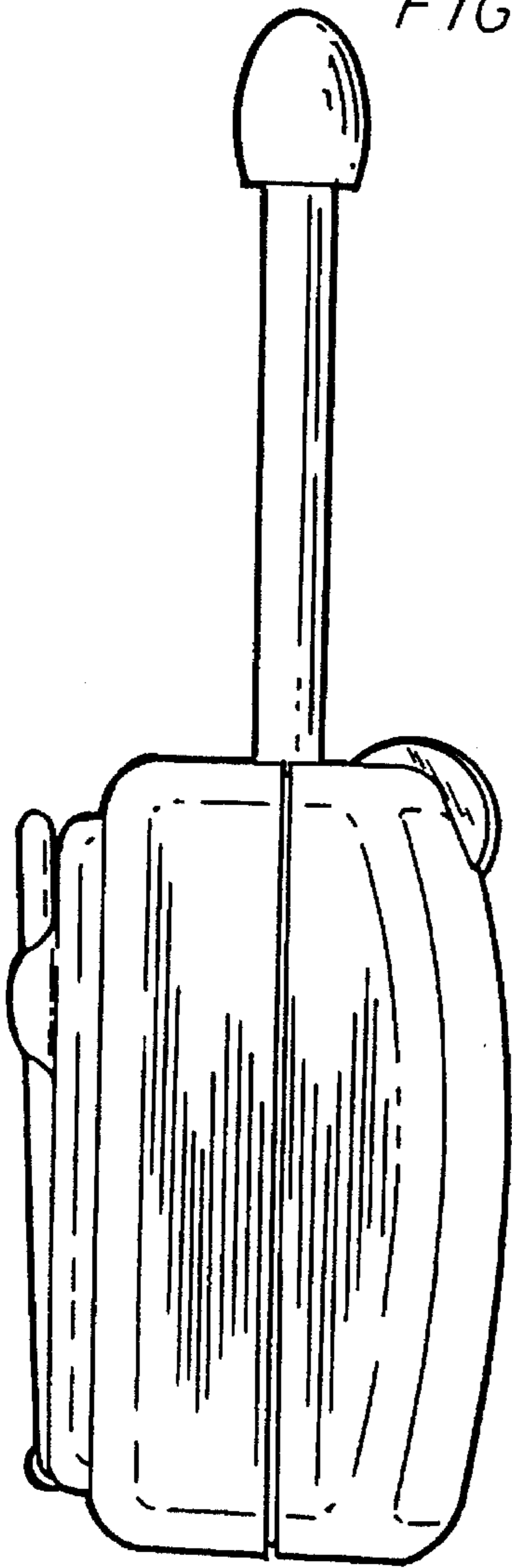

FIG - 6

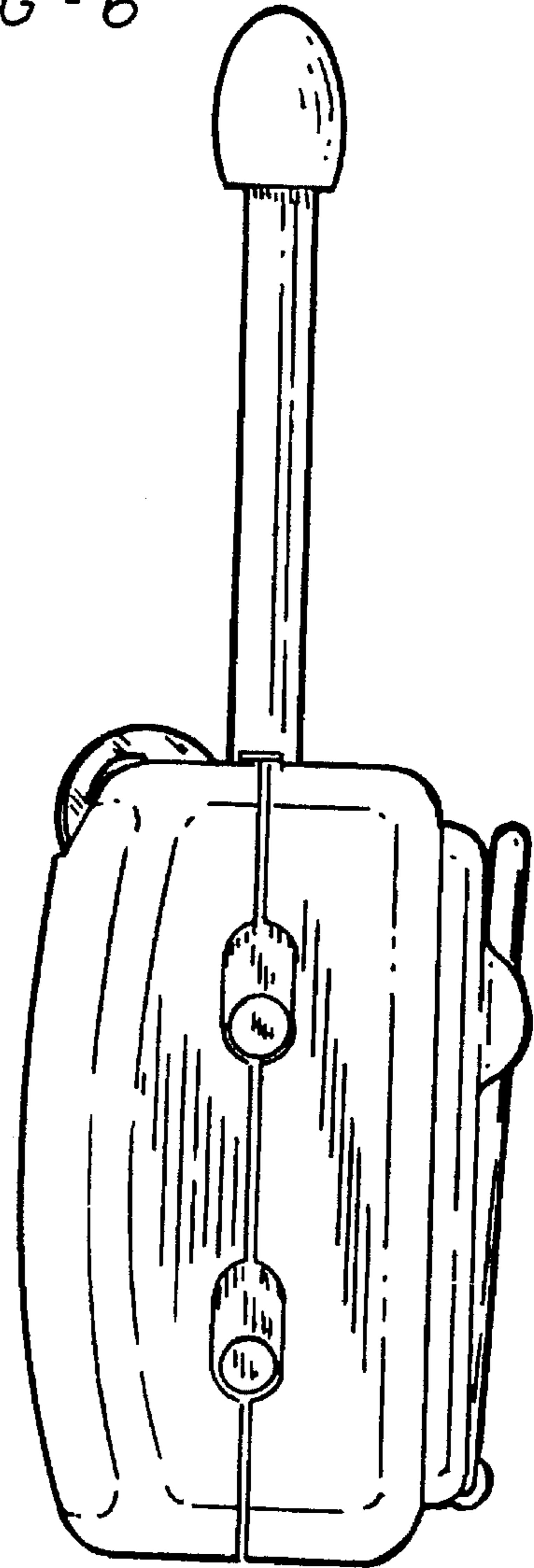

FIG - 7

