



US00D376919S

**United States Patent** [19]  
**Sedlack**

[11] **Patent Number: Des. 376,919**

[45] **Date of Patent: \*\*Dec. 31, 1996**

[54] **CAR SEAT BASE**

D. 326,566 6/1992 McNeil ..... D6/333

[75] **Inventor: Mark A. Sedlack, Cuyahoga Falls, Ohio**

*Primary Examiner*—Gary D. Watson  
*Attorney, Agent, or Firm*—Graham & James LLP

[73] **Assignee: Century Products Company, Macedonia, Ohio**

[57] **CLAIM**

[\*\*] **Term: 14 Years**

The ornamental design for a car seat base, as shown and described.

[21] **Appl. No.: 46,351**

**DESCRIPTION**

[22] **Filed: Nov. 13, 1995**

FIG. 1 is a perspective view of the invention;

[52] **U.S. Cl. .... D6/333**

FIG. 2 is a top plan view of the invention;

[58] **Field of Search ..... D6/333, 334, 495, D6/496, 500, 501, 502; 297/130, 256.16**

FIG. 3 is a rear edge view of the invention;

FIG. 4 is a left side view of the invention;

FIG. 5 is a front edge view of the invention; and,

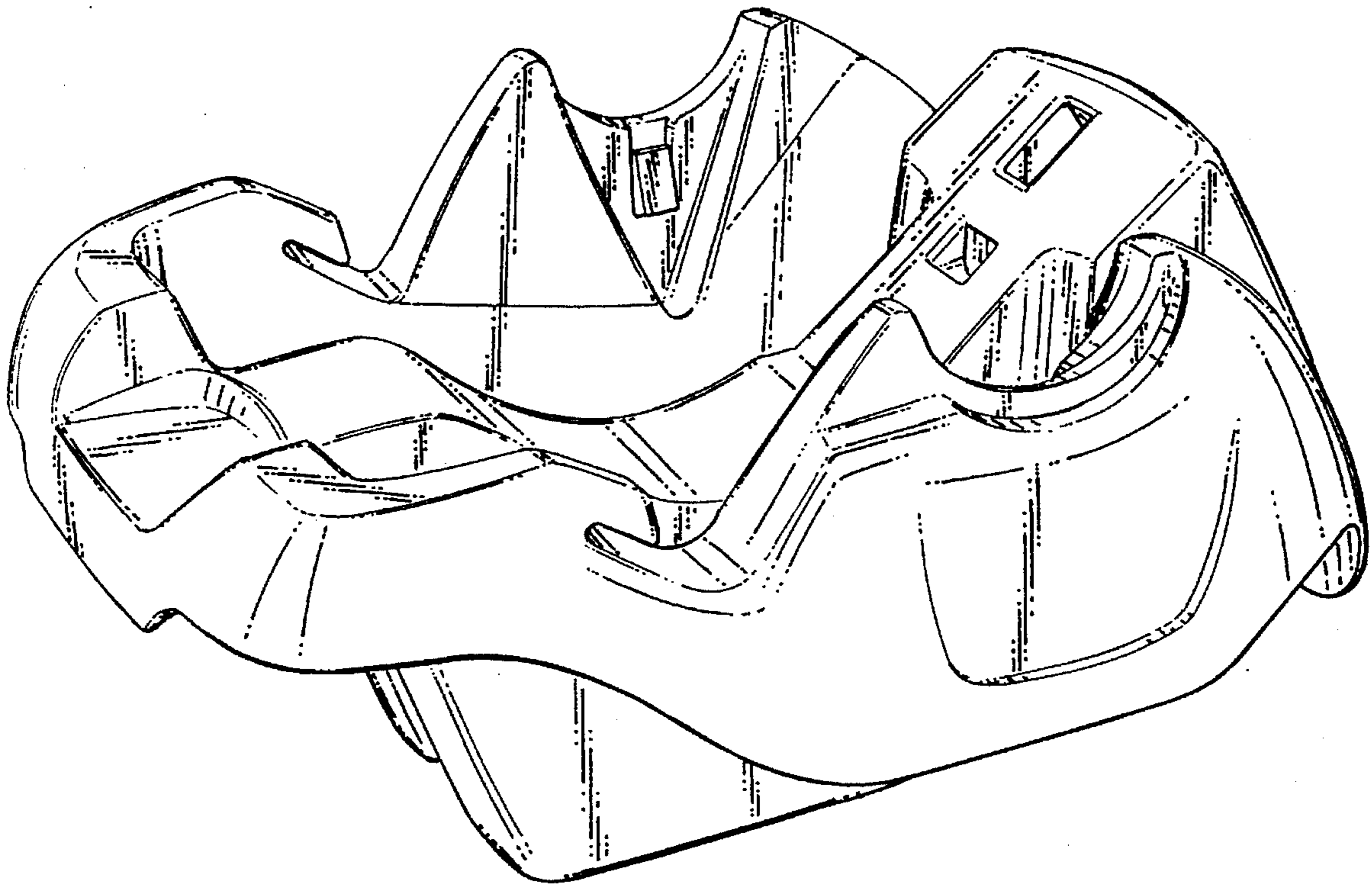
FIG. 6 is a bottom plan view of the invention.

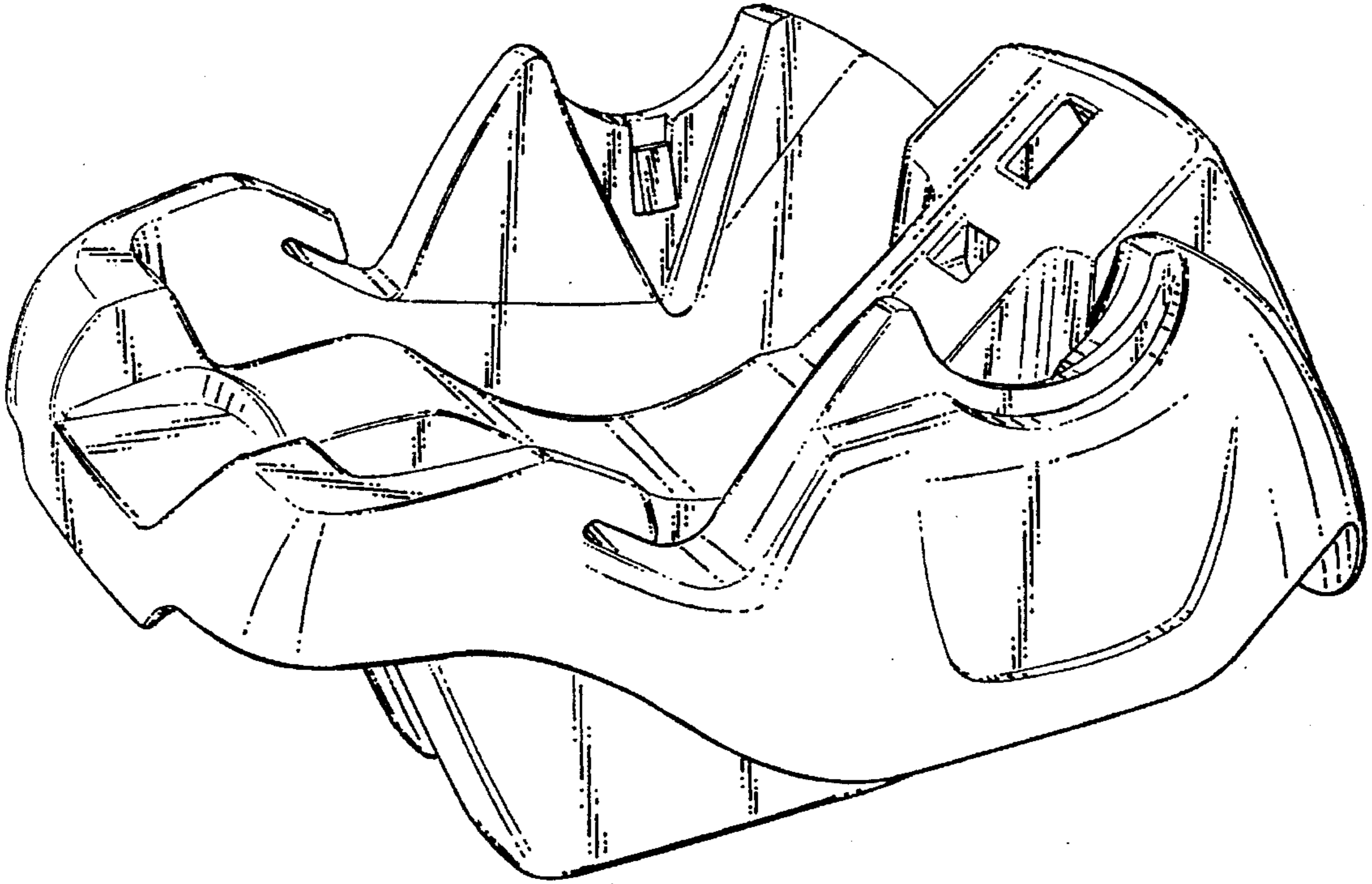
[56] **References Cited**

**U.S. PATENT DOCUMENTS**

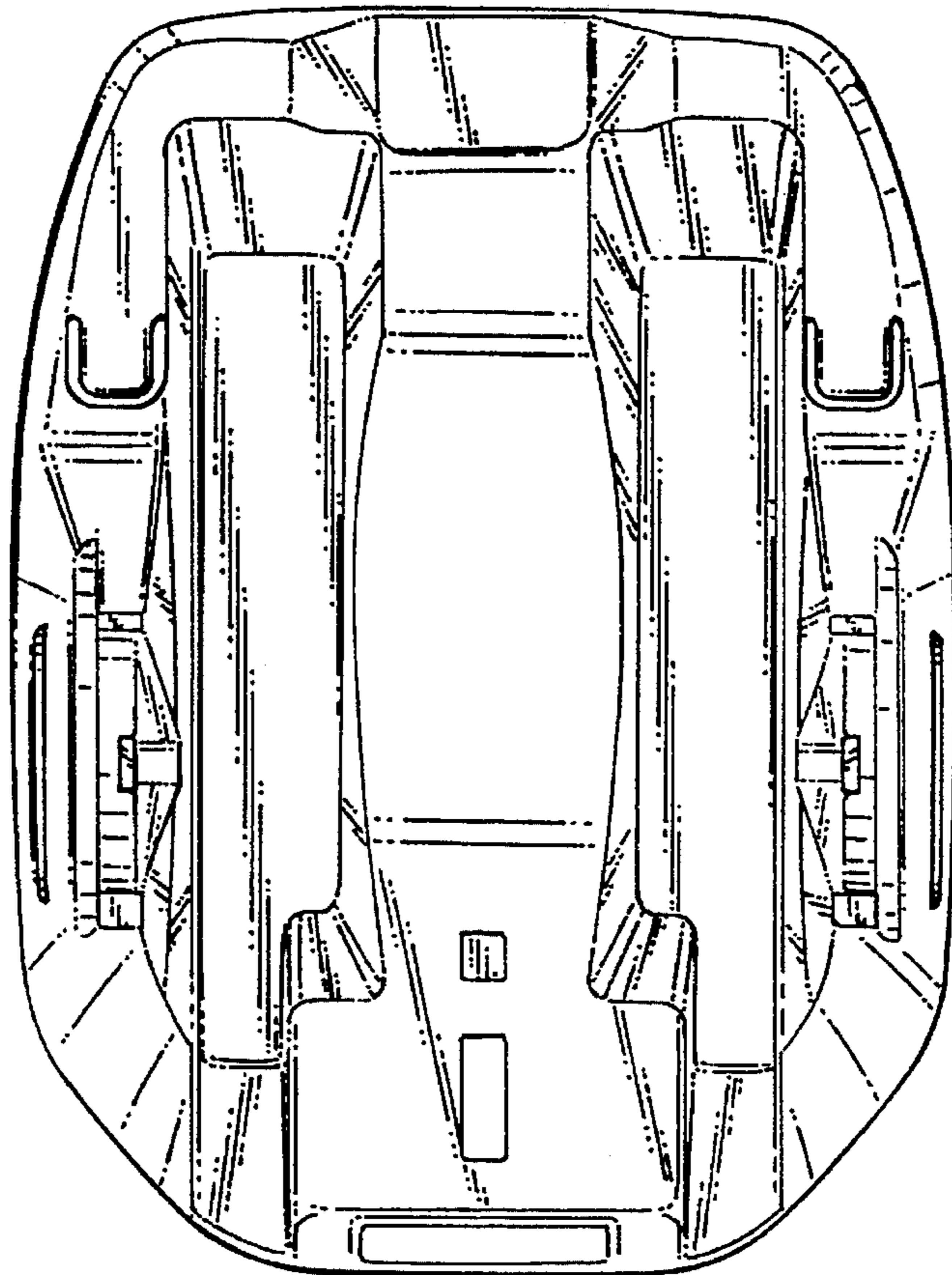
D. 321,449 11/1991 Meeker ..... D6/496

**1 Claim, 3 Drawing Sheets**

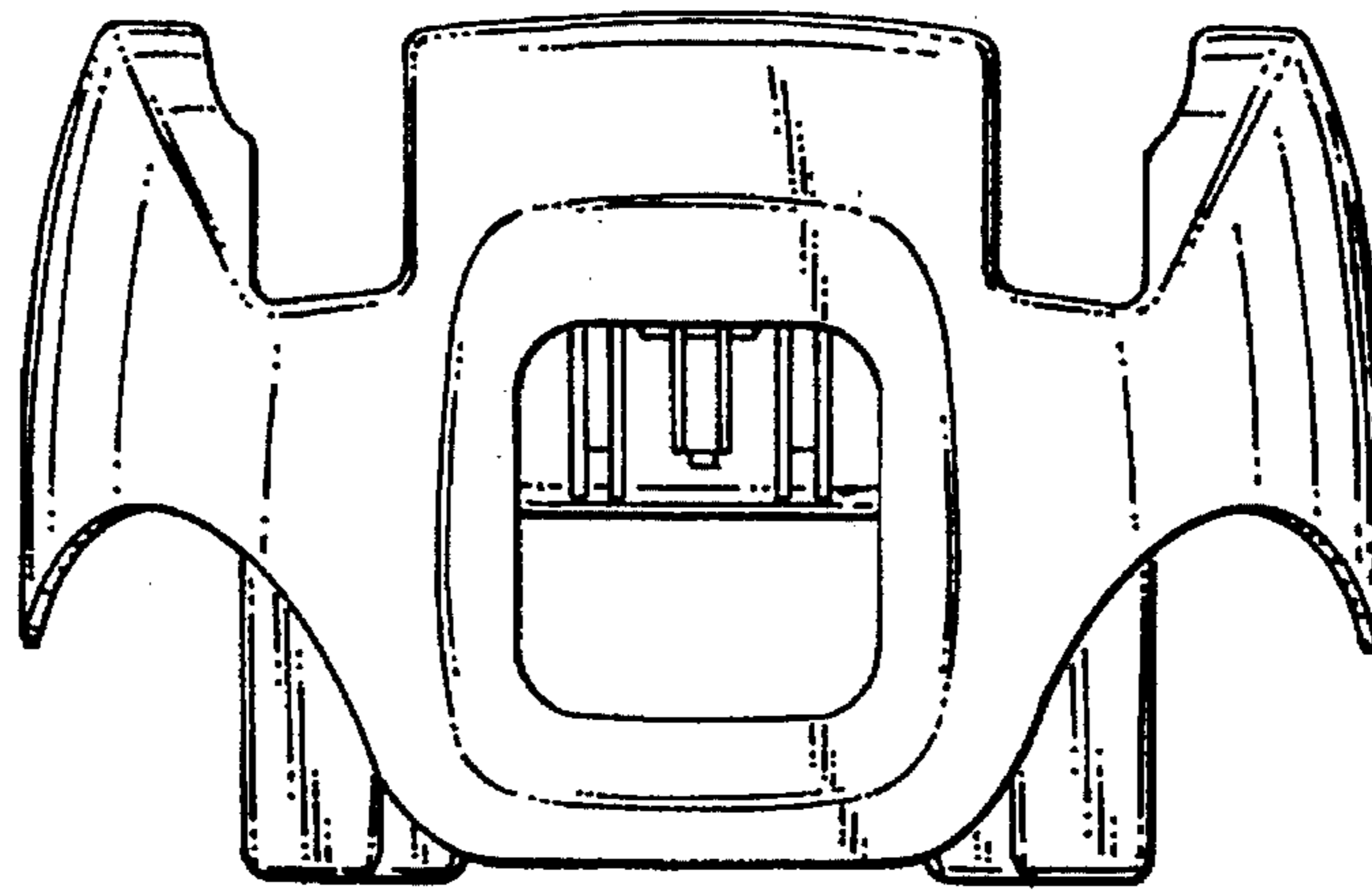




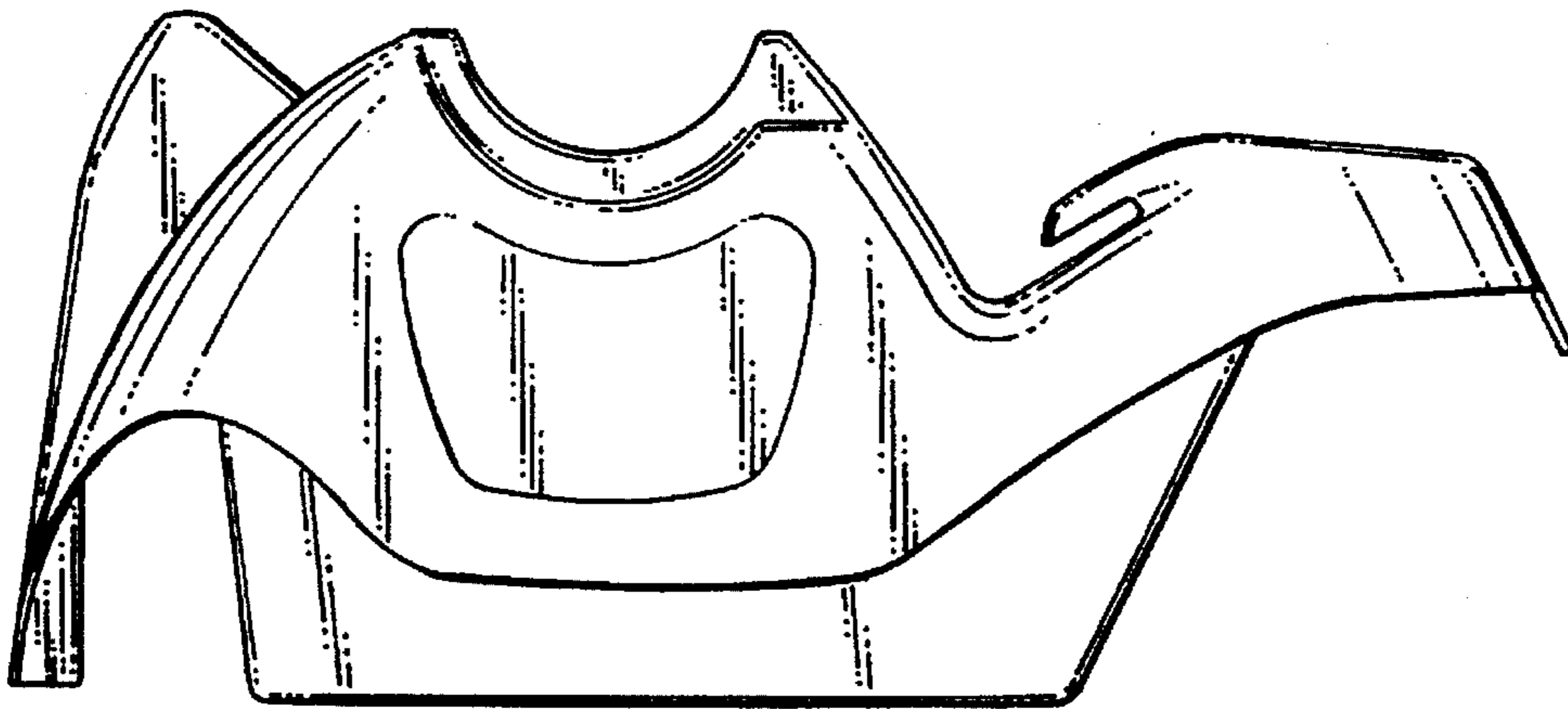
**FIG. 1.**



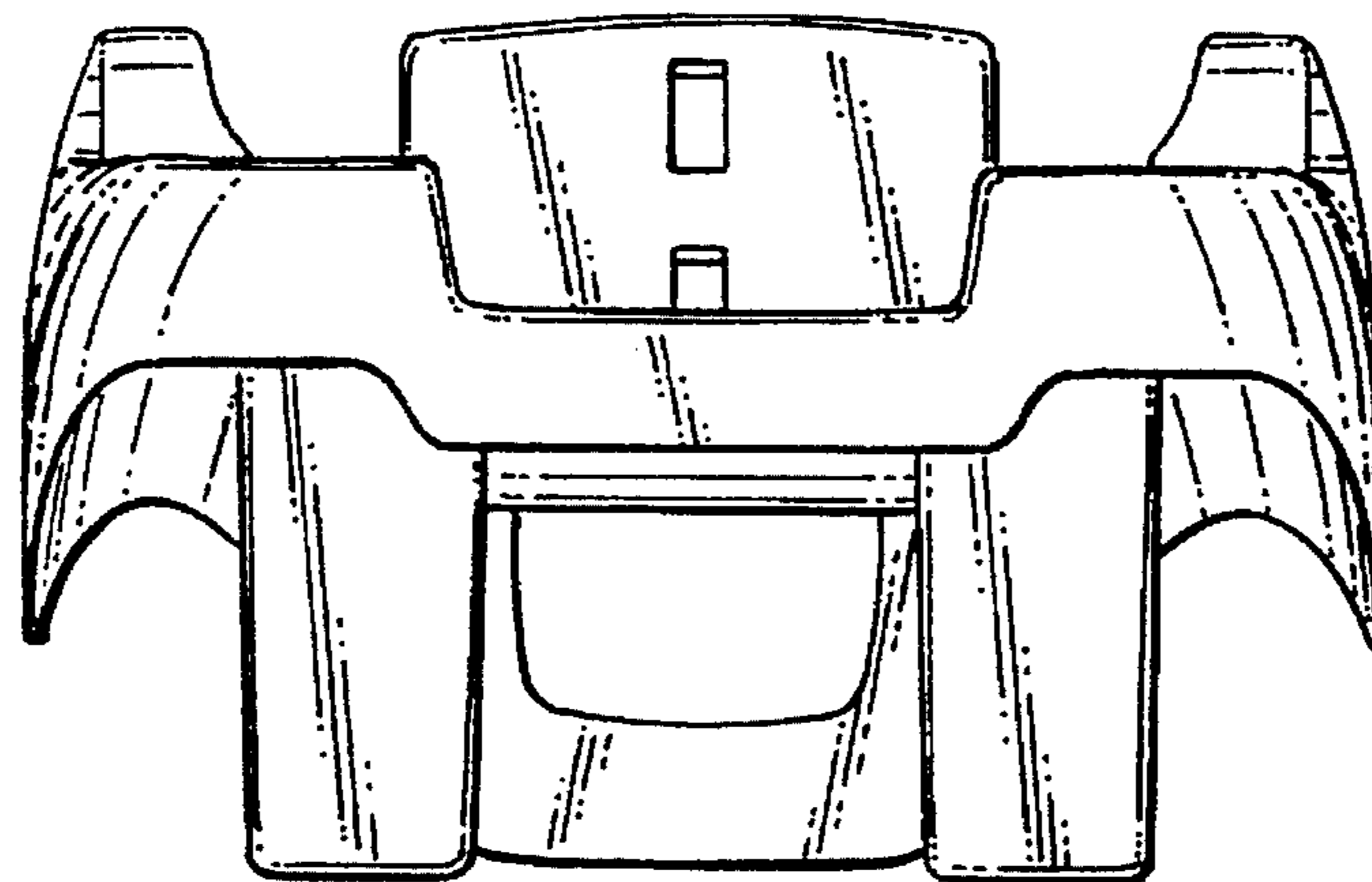
**FIG. 2.**



**FIG. 3.**

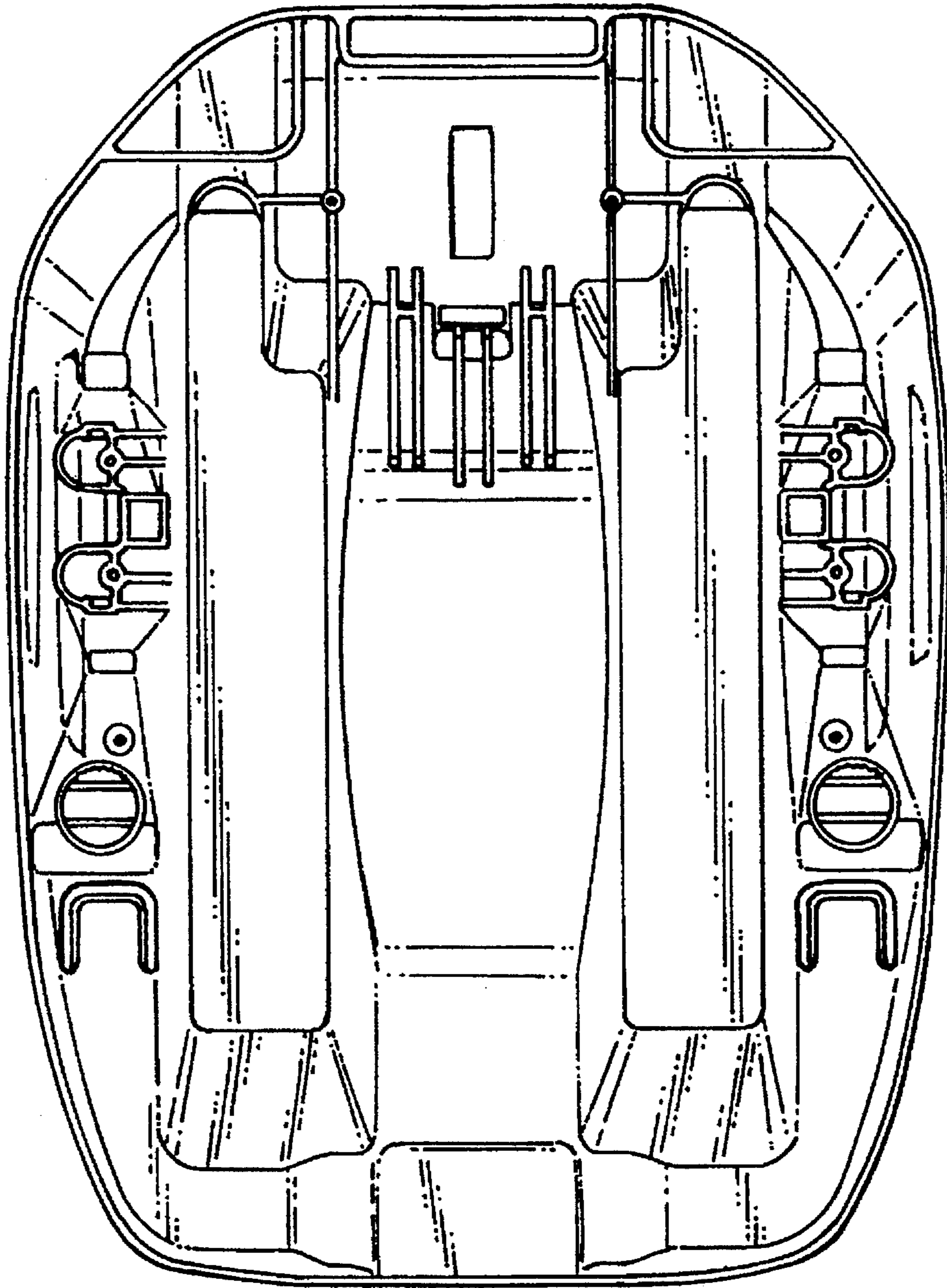


**FIG. 4.**



**FIG. 5.**





**FIG. 6.**