



US00D376819S

United States Patent [19]

[11] Patent Number: **Des. 376,819**

Milcetic

[45] Date of Patent: ****Dec. 24, 1996**

[54] VENDING MACHINE HOUSING

[57] CLAIM

[76] Inventor: **Duncan J. Milcetic**, 91 Clapham Ave.,
Manhasset, N.Y. 11030

The ornamental design for a vending machine housing, as shown and described.

[**] Term: **14 Years**

DESCRIPTION

[21] Appl. No.: **40,488**

[22] Filed: **Jun. 20, 1995**

Related U.S. Application Data

[63] Continuation-in-part of Ser. No. 208,724, Mar. 9, 1994, Pat. No. 5,472,074.

[52] U.S. Cl. **D20/1**

[58] Field of Search D20/1-9; D9/339;
194/294, 342, 343, 350; 221/240

FIG. 1 is a front, right side, top perspective view of a vending machine housing, showing my new design;

FIG. 2 is a right side elevational view thereof;

FIG. 3 is a front side elevational view thereof;

FIG. 4 is a left side elevational view thereof;

FIG. 5 is a rear side elevational view thereof;

FIG. 6 is a top plan view thereof;

FIG. 7 is a bottom plan view thereof;

FIG. 8 is a cross-sectional view taken along the line VIII—VIII from FIG. 5;

FIG. 9 is a cross-sectional view taken along the line IX—IX from FIG. 5;

FIG. 10 is a front, right-side, top perspective view of a second embodiment of the housing as disclosed in FIG. 1;

FIG. 11 is a right side elevational view of FIG. 10;

FIG. 12 is a front side elevational view of FIG. 10;

FIG. 13 is a left side elevational view of FIG. 10;

FIG. 14 is a rear side elevational view of FIG. 10;

FIG. 15 is a top plan view of FIG. 10;

FIG. 16 is a bottom plan view of FIG. 10; and,

FIG. 17 is a cross-sectional view taken along the line XVII—XVII from FIG. 14.

The broken away sections are due to the indeterminate length of the claimed design.

[56] References Cited

U.S. PATENT DOCUMENTS

D. 38,128	7/1906	McLouth	D20/1
D. 53,272	5/1919	Messinger	D20/1
D. 103,418	3/1937	Walzer	D20/1
D. 153,802	5/1949	Hokinson	D20/1
D. 321,647	11/1991	Oldorf	D9/339
D. 335,149	4/1993	Dabrowski	D20/1
1,711,838	5/1929	Goldie .	
2,902,187	9/1959	Cabanban .	
3,540,564	11/1970	Brand .	
4,966,304	10/1990	Kelly	194/350
5,082,101	1/1992	Baker et al. .	
5,244,071	9/1993	Lobl	194/342

Primary Examiner—Ted Shooman

Assistant Examiner—Mitchell I. Siegel

Attorney, Agent, or Firm—Collard & Roe, P.C.

1 Claim, 8 Drawing Sheets

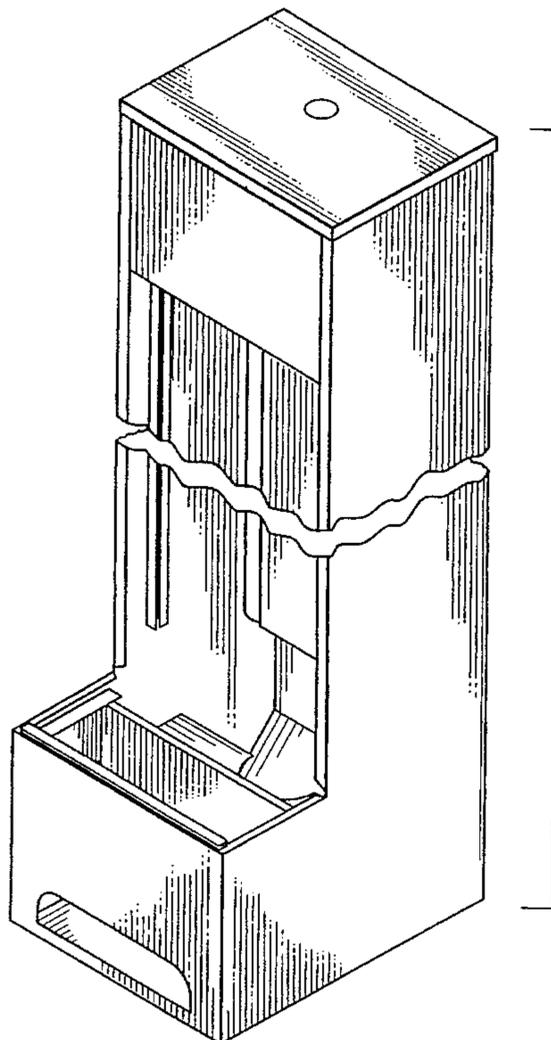

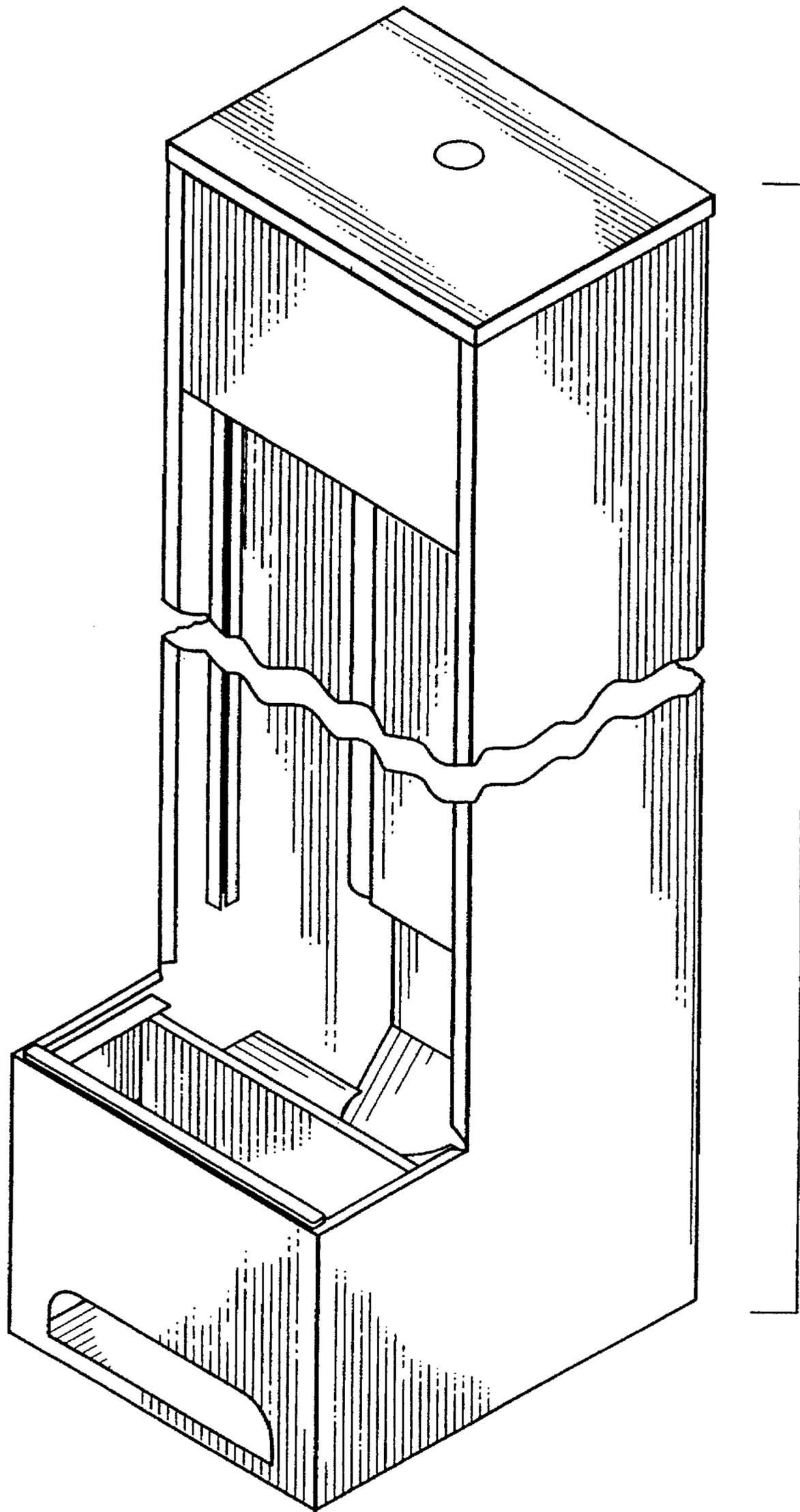

Fig. 1

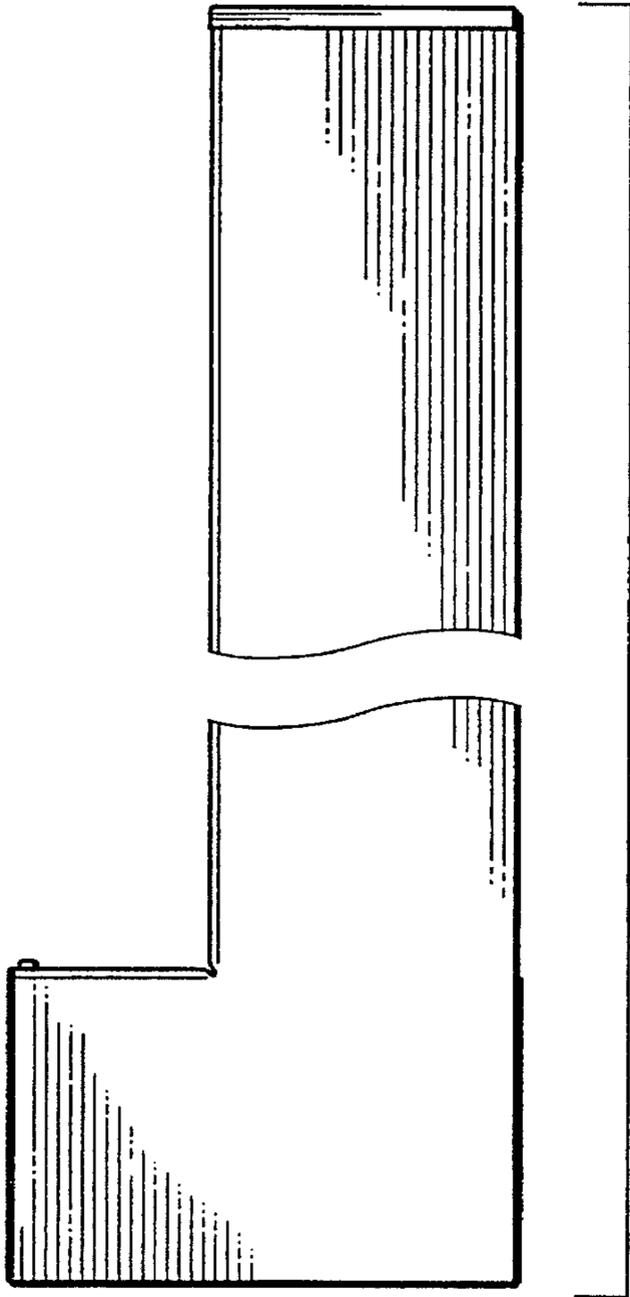

Fig. 2

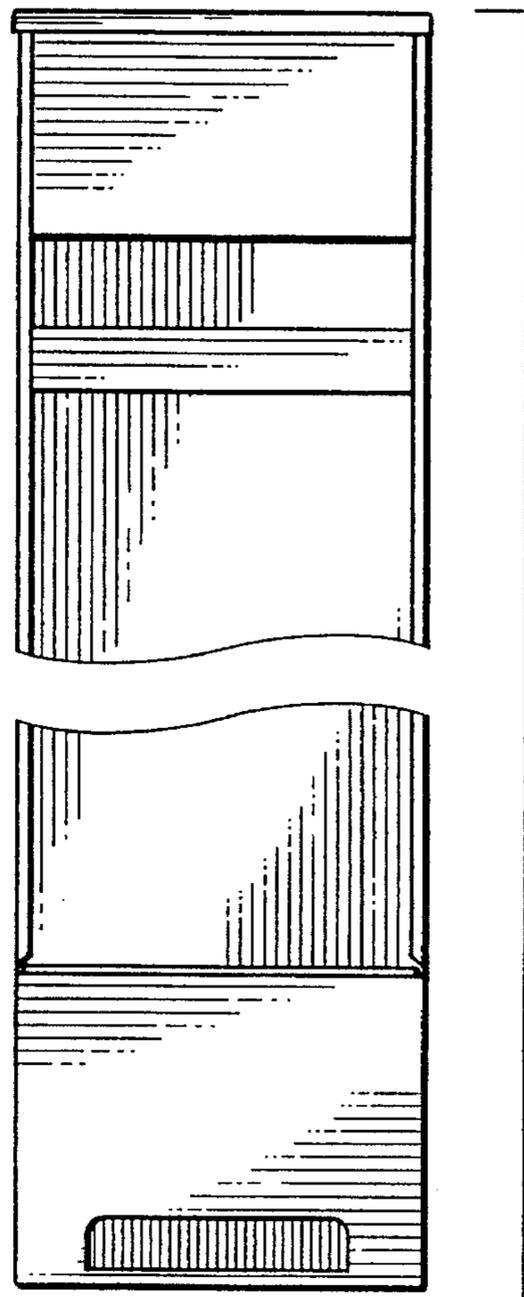

Fig. 3

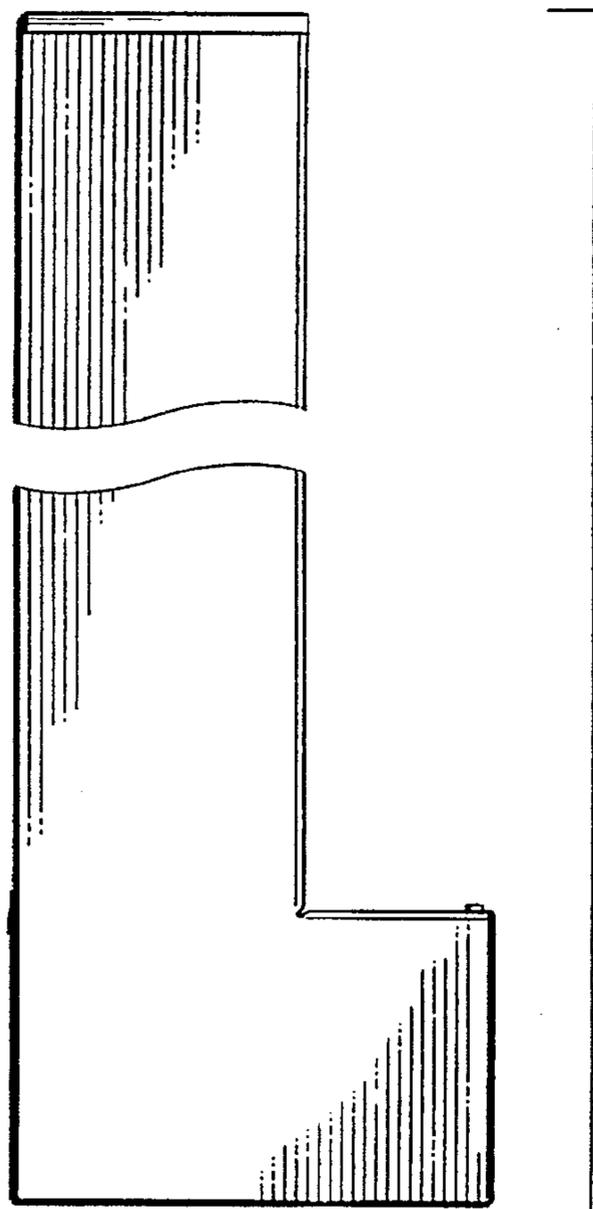

Fig. 4

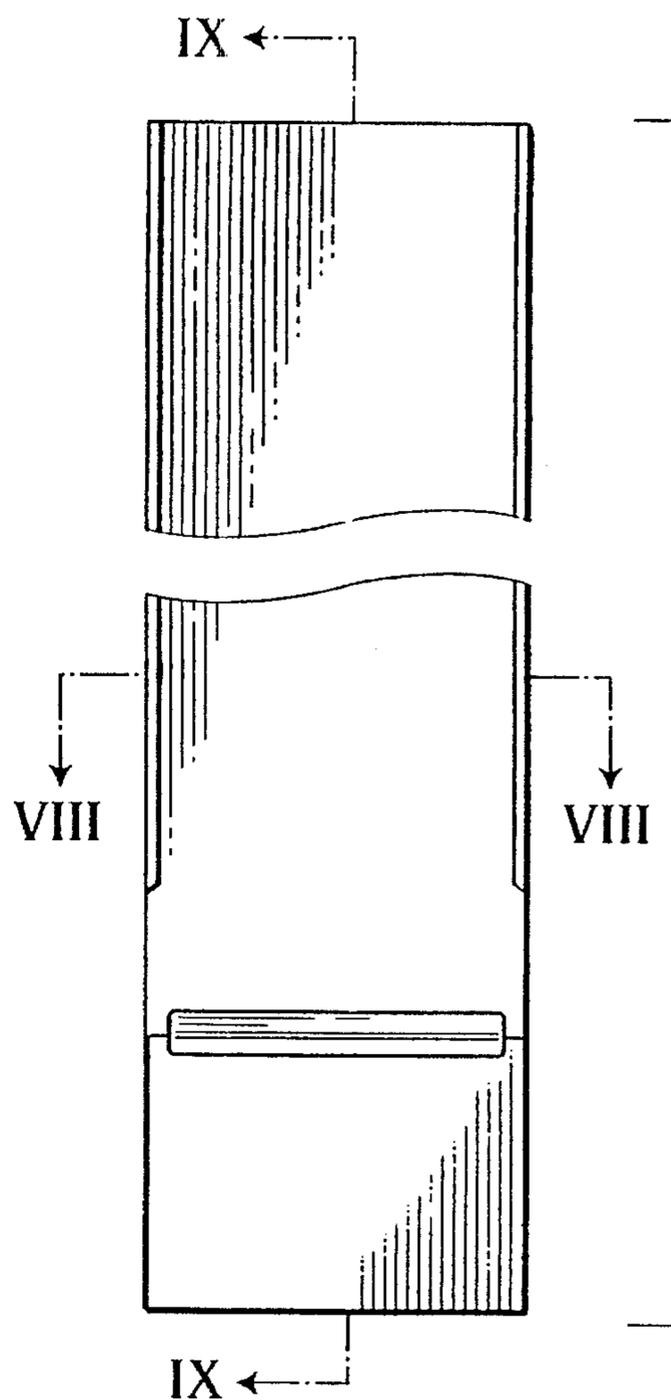

Fig. 5

Fig. 6

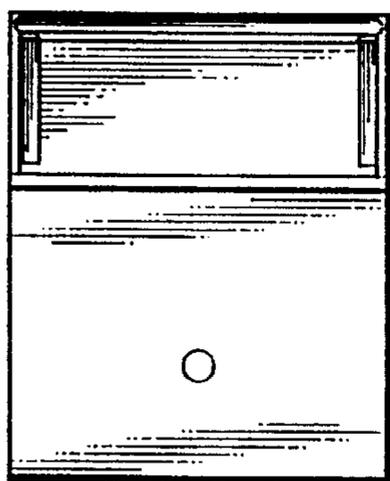
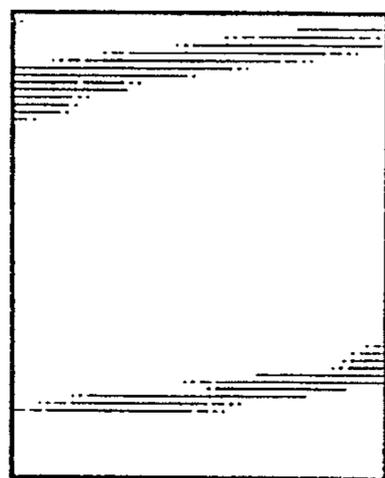

Fig. 7



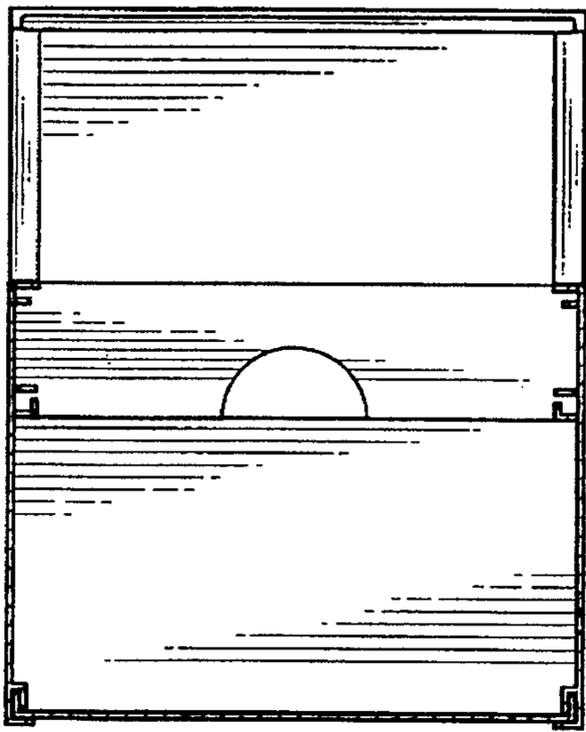

Fig. 8

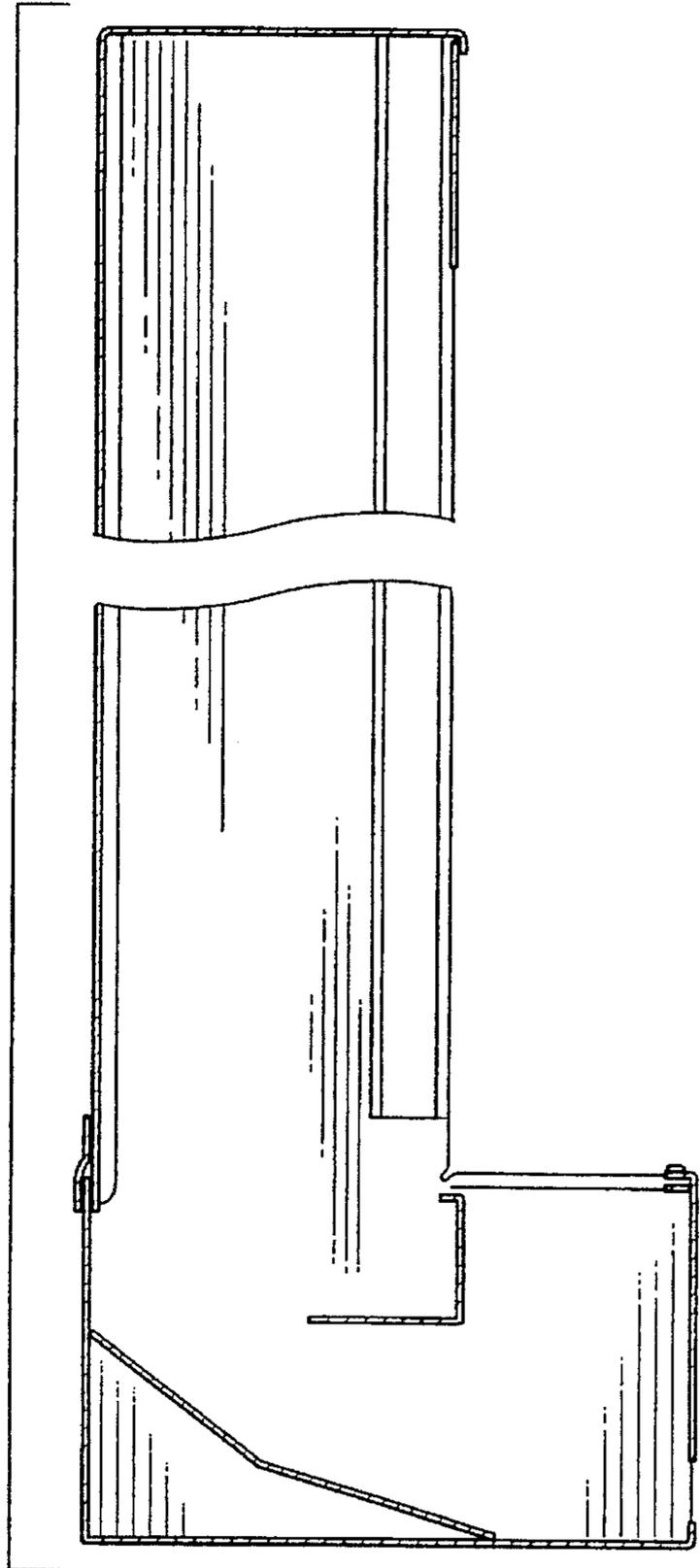

Fig. 9

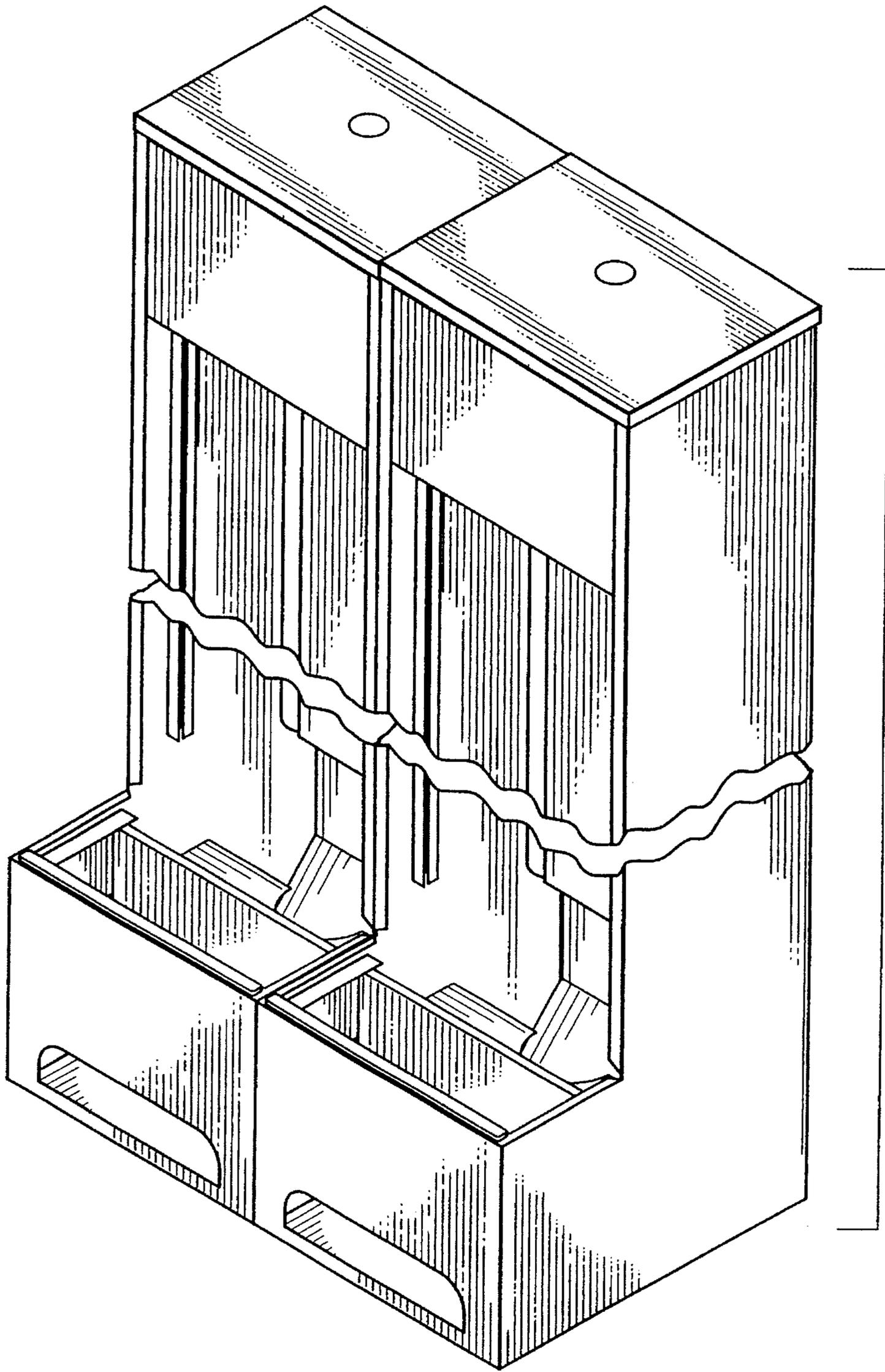

Fig. 10

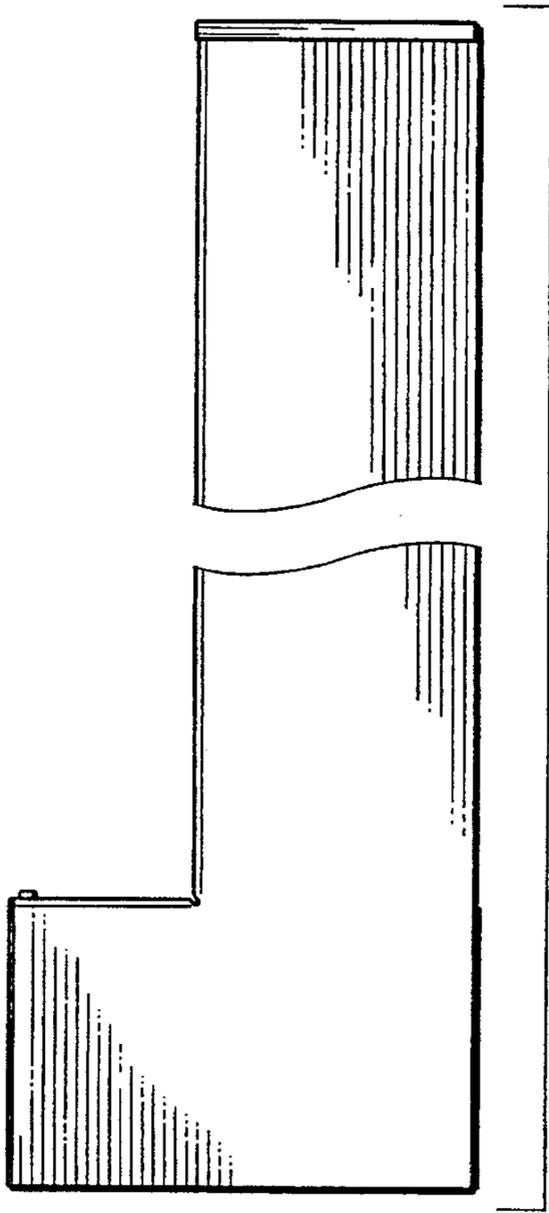

Fig. 11

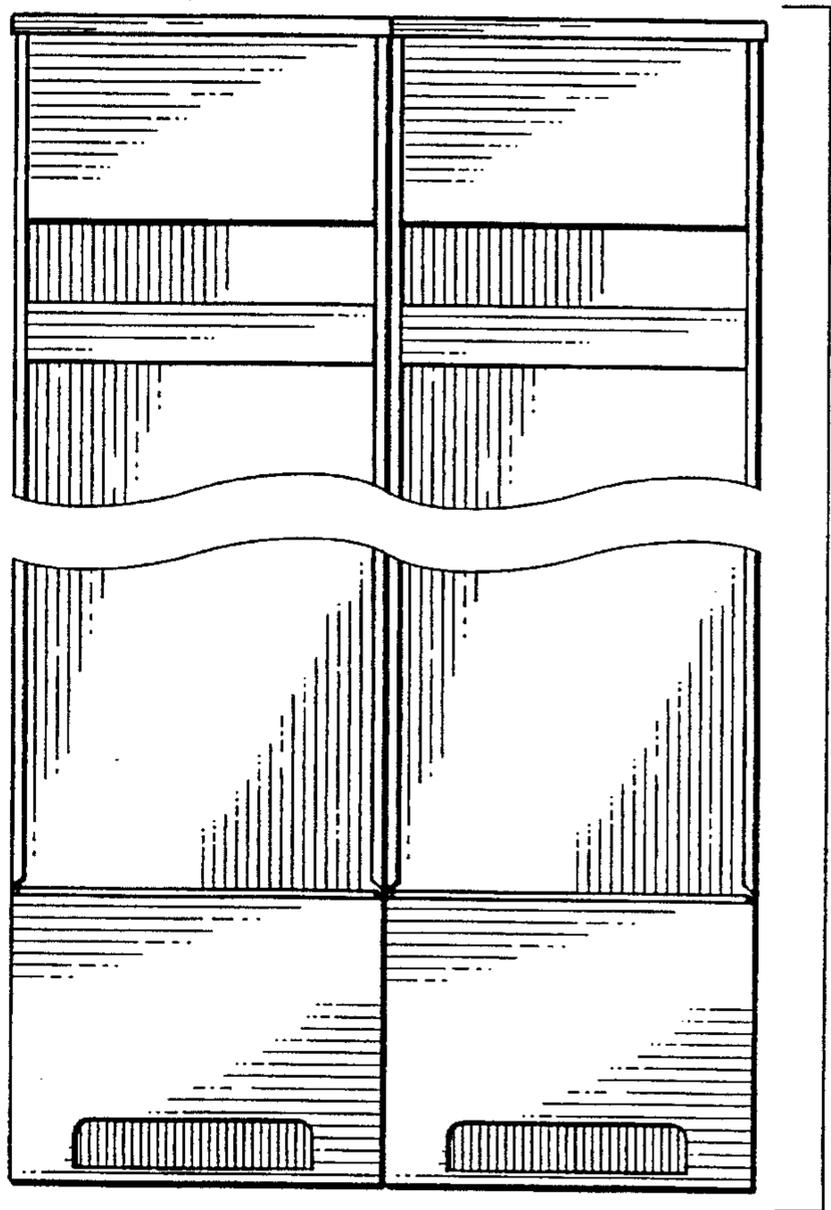

Fig. 12

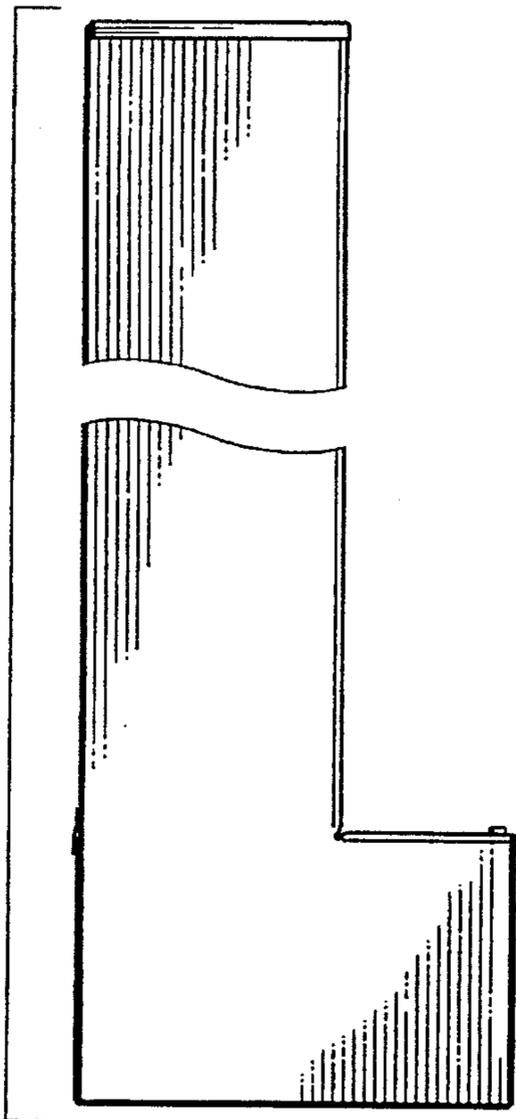

Fig. 13

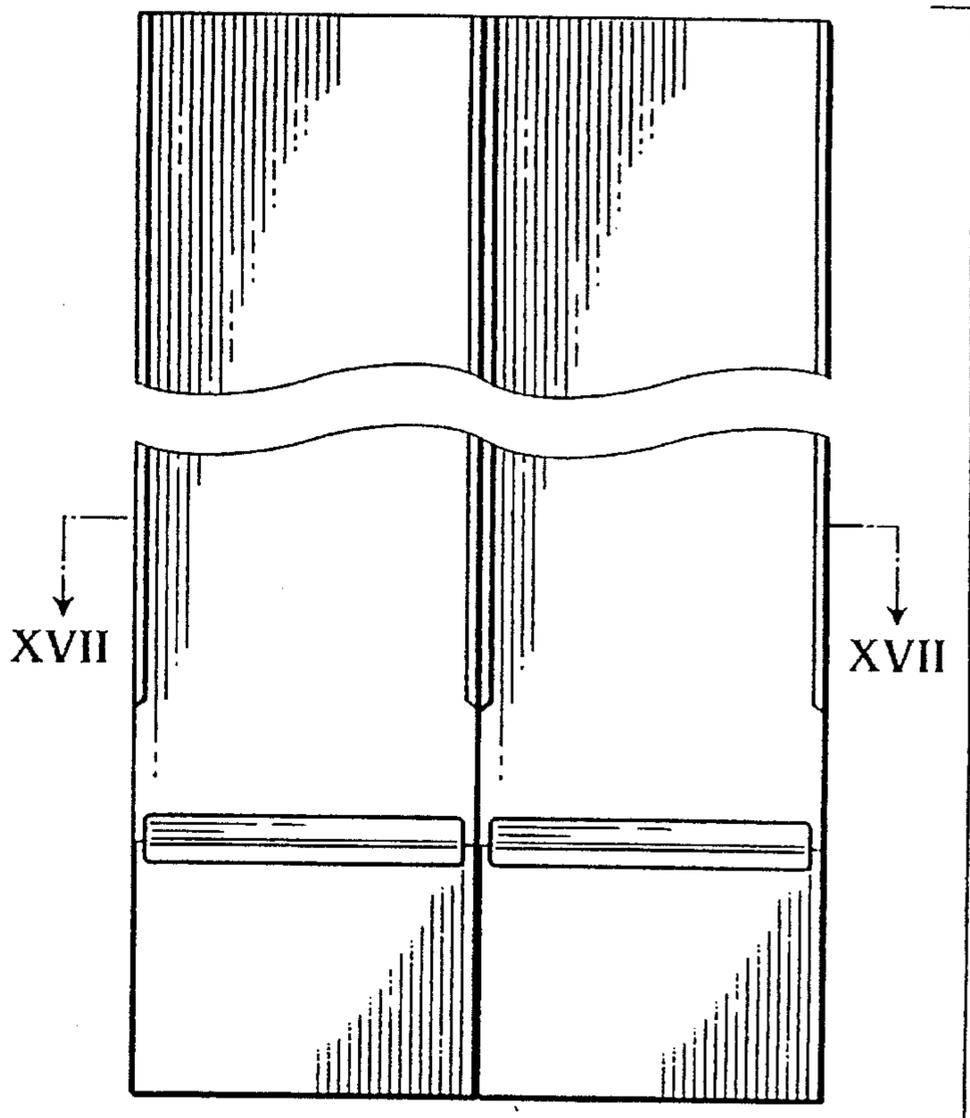

Fig. 14

Fig. 15

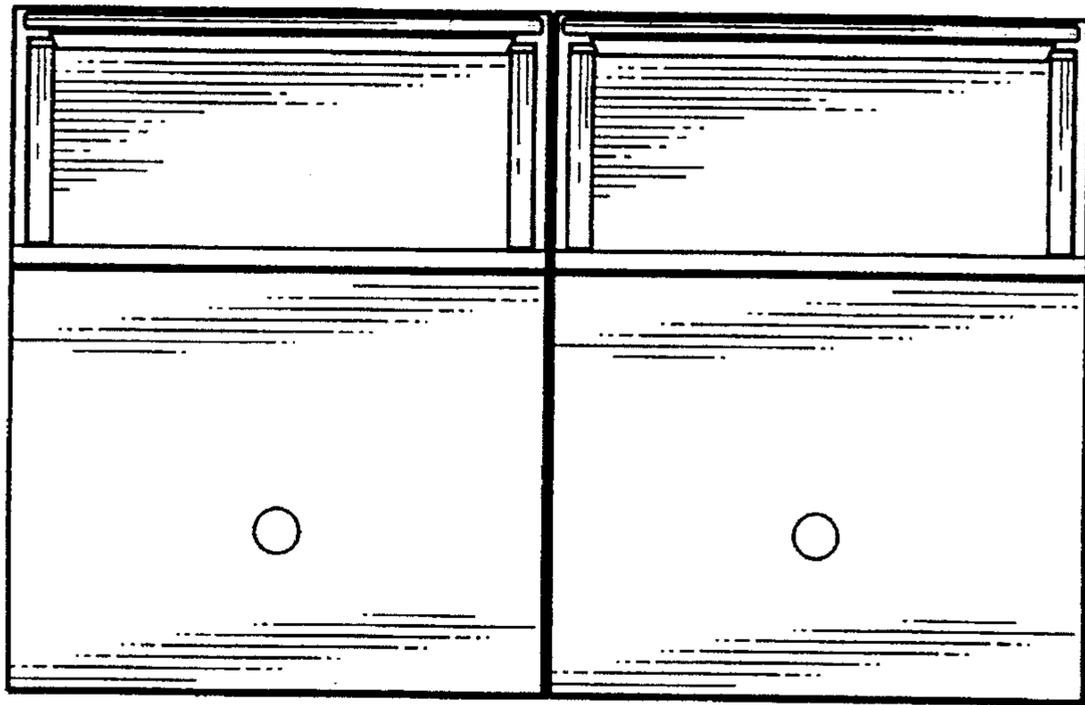

Fig. 16

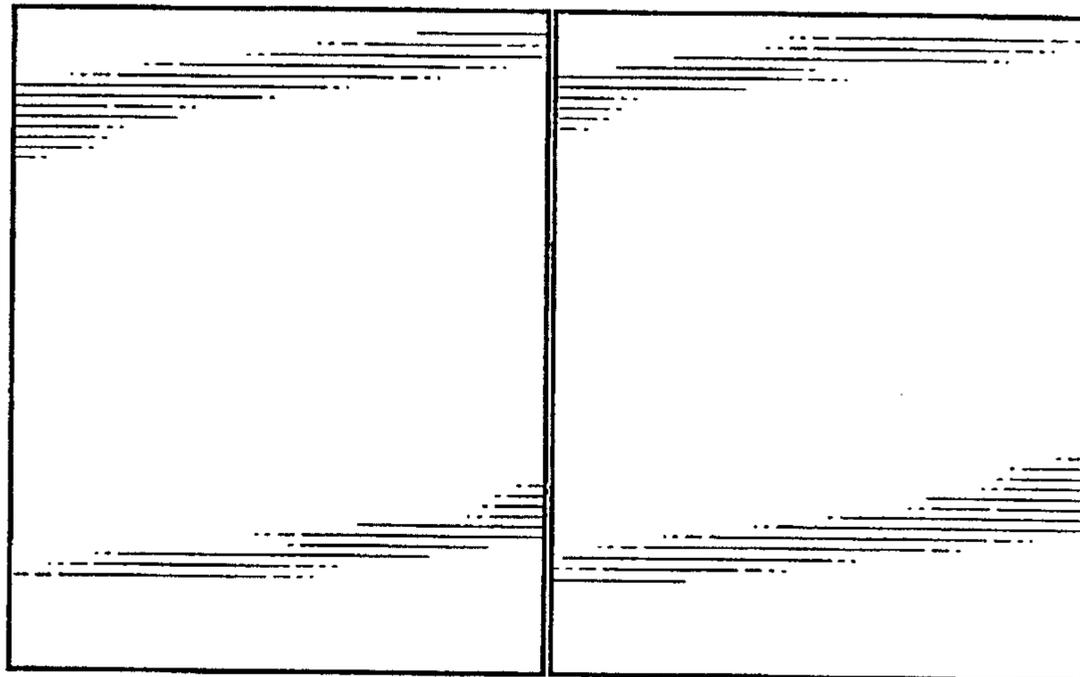

Fig. 17

