



US00D376770S

United States Patent [19]

[11] **Patent Number: Des. 376,770**

Vasquez

[45] **Date of Patent: **Dec. 24, 1996**

[54] **GIFT PACKAGE ORNAMENT**

3,955,752 5/1976 Harrigan D19/3 X
4,476,167 10/1981 Duffler D11/184 X

[76] Inventor: **Michelle Vasquez**, 5297 Clato St.,
Kalamazoo, Mich. 49004

Primary Examiner—Dominic Simone
Attorney, Agent, or Firm—Harold H. Dutton, Jr.; W. Charles
L. Jamison; Diane S. Liebman

[**] Term: **14 Years**

[21] Appl. No.: **47,366**

[57] **CLAIM**

[22] Filed: **Dec. 1, 1995**

The ornamental design for a gift package ornament, as shown.

[52] U.S. Cl. **D11/184**

[58] Field of Search D11/184; D27/183,
D27/185, 186; D21/187; D19/3; 428/7;
229/68.1, 928, 929

DESCRIPTION

FIG. 1 is a perspective view of a gift package ornament showing my new design;
FIG. 2 is a reduced rear elevational view thereof;
FIG. 3 is a reduced left side elevational view thereof;
FIG. 4 is a reduced right side elevational view thereof;
FIG. 5 is a reduced top plan view thereof; and,
FIG. 6 is a reduced bottom plan view thereof.

[56] **References Cited**

U.S. PATENT DOCUMENTS

D. 214,231	5/1969	Schmidt	D11/184
D. 265,694	8/1982	Sogoian et al.	D27/186 X
D. 319,419	8/1991	Cheng	D11/184
D. 342,921	1/1994	Cheng	D11/184
3,310,225	3/1967	Hohlit	D19/3 X

1 Claim, 4 Drawing Sheets

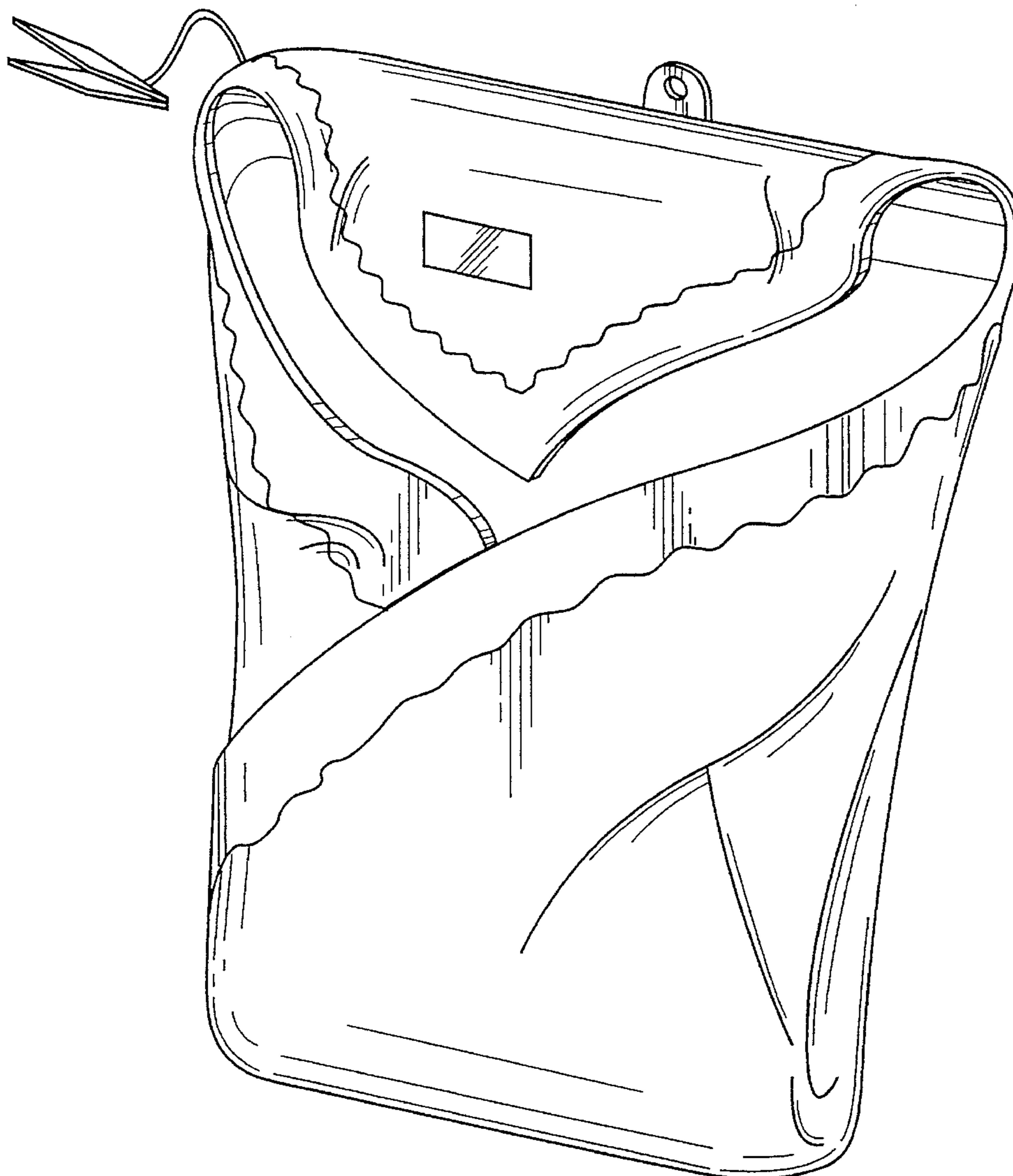

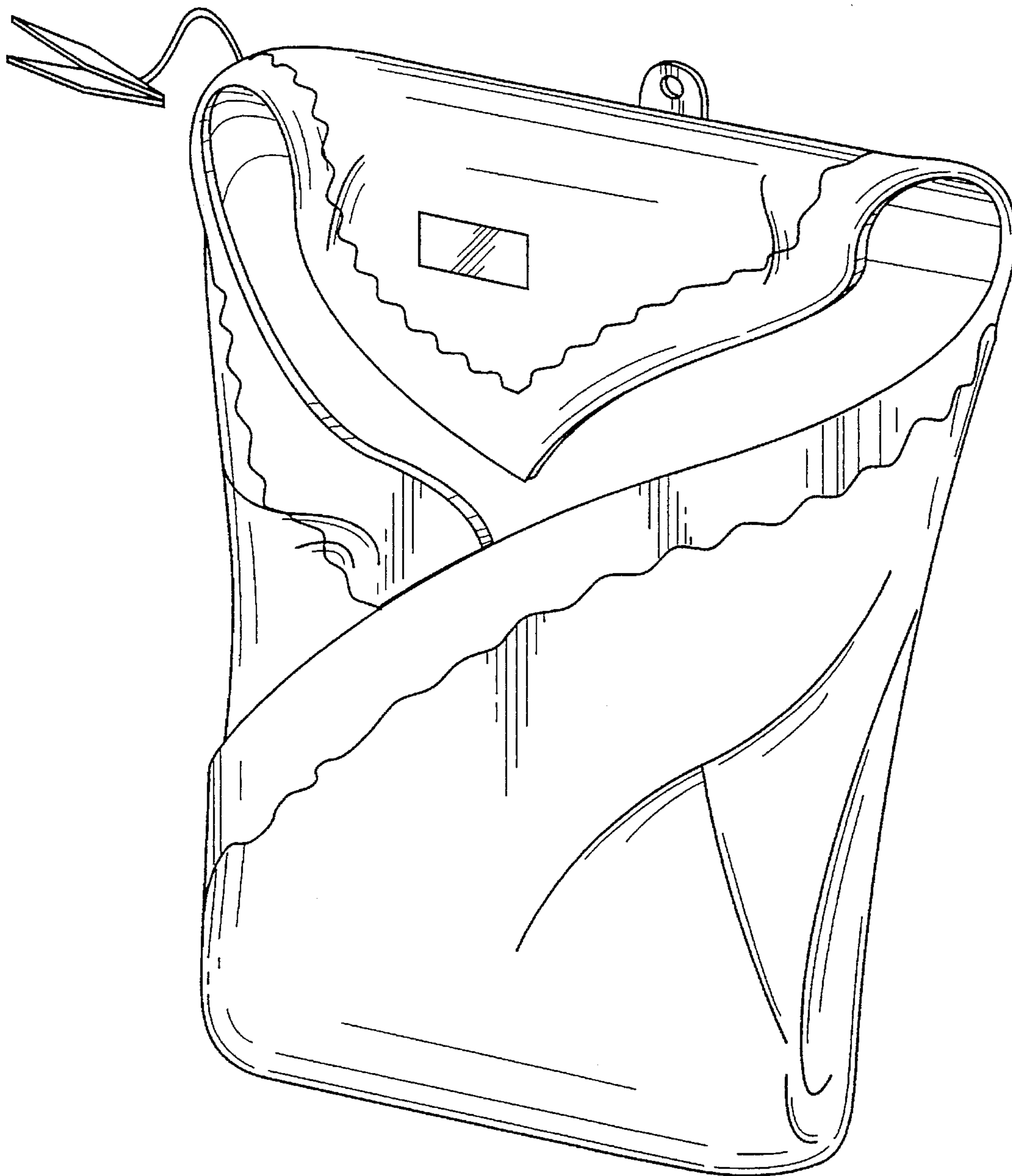

FIG. 1

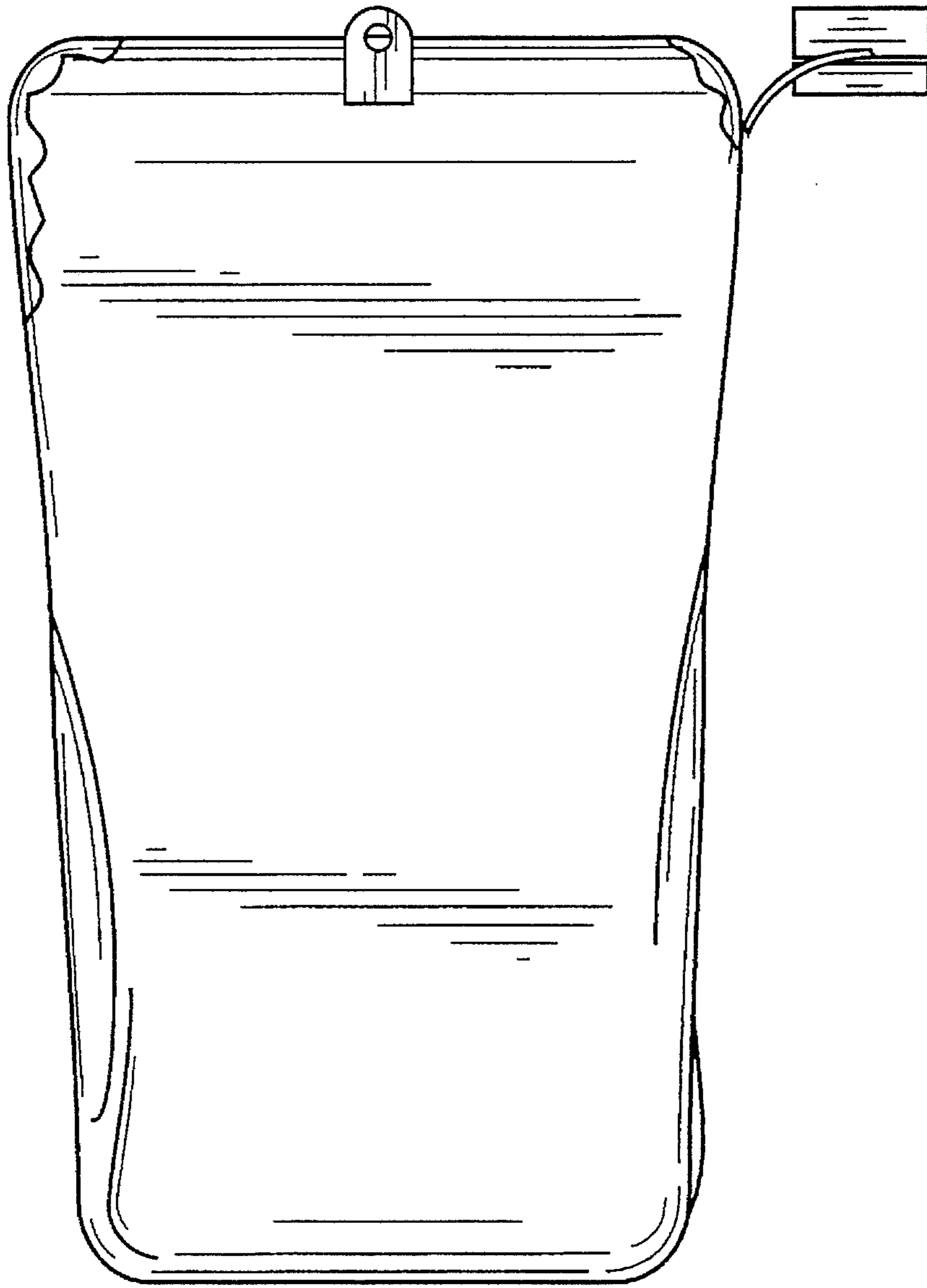

FIG. 2

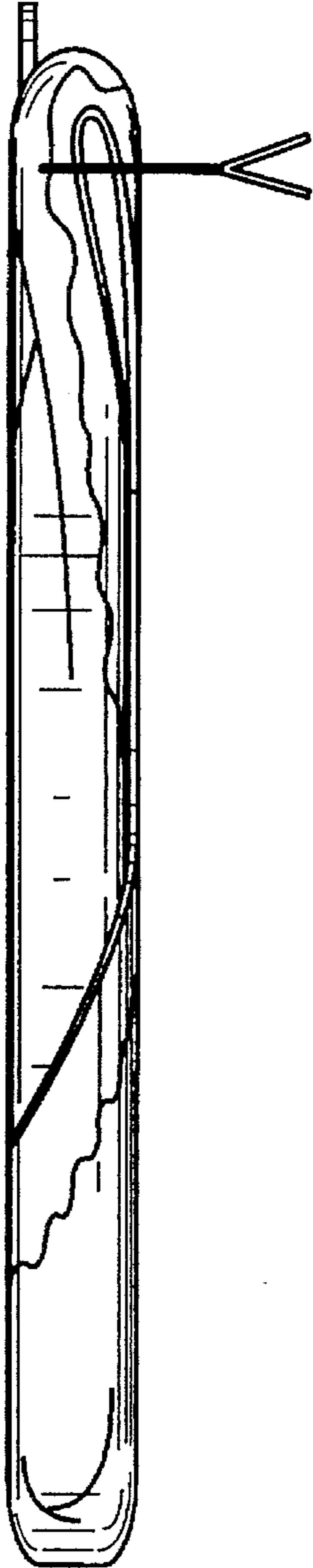

FIG. 3

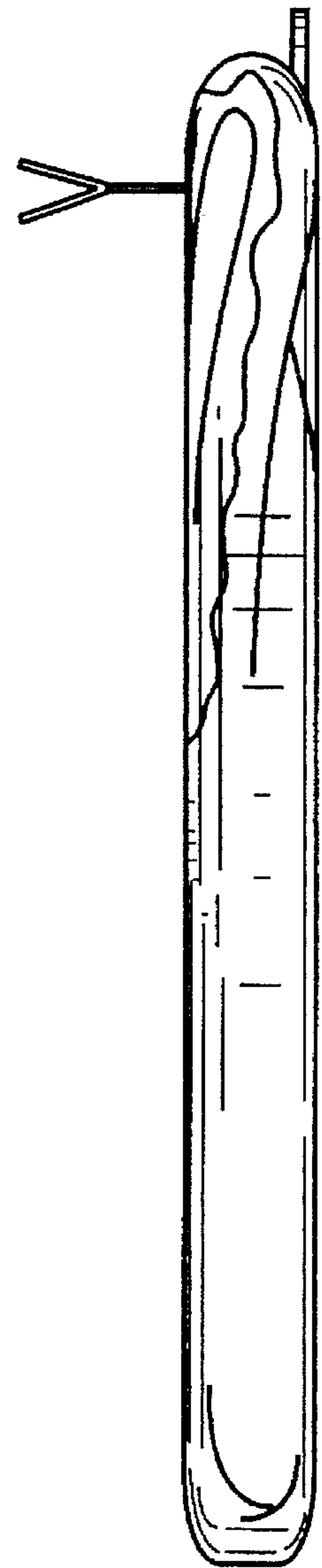

FIG. 4

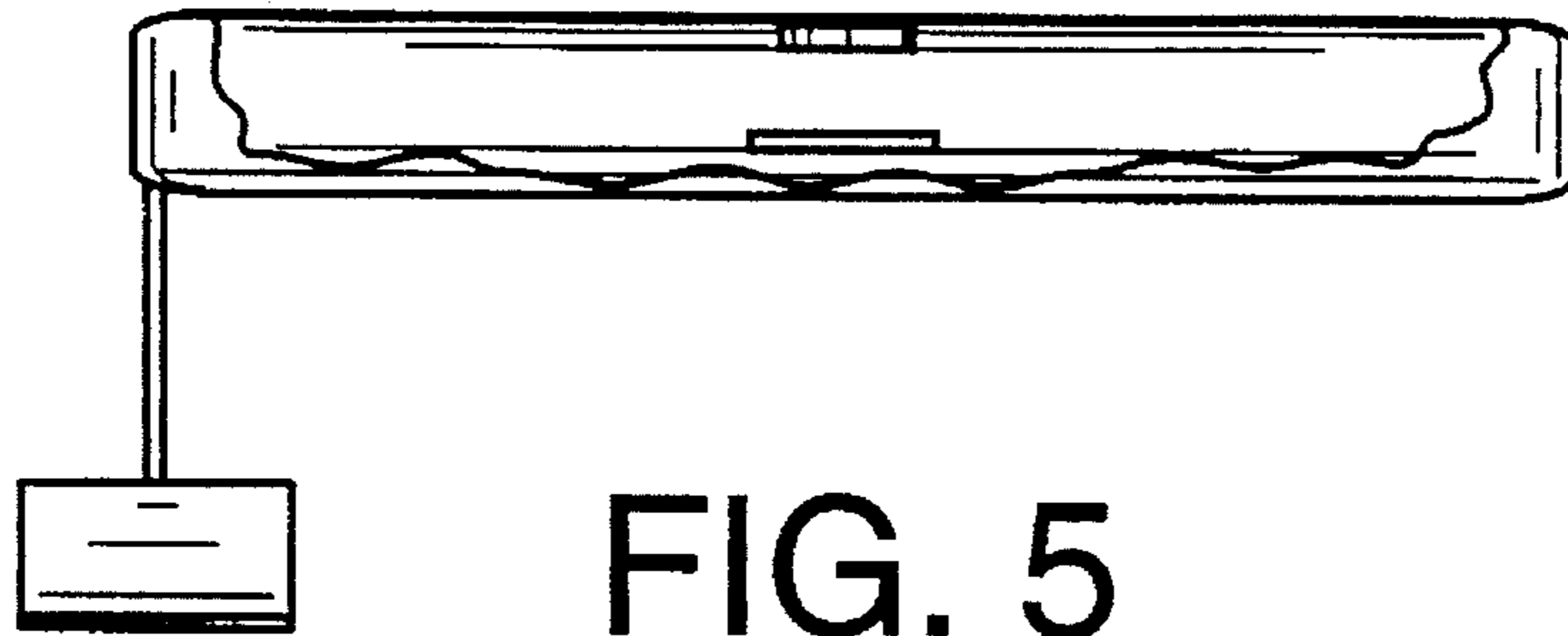

FIG. 5

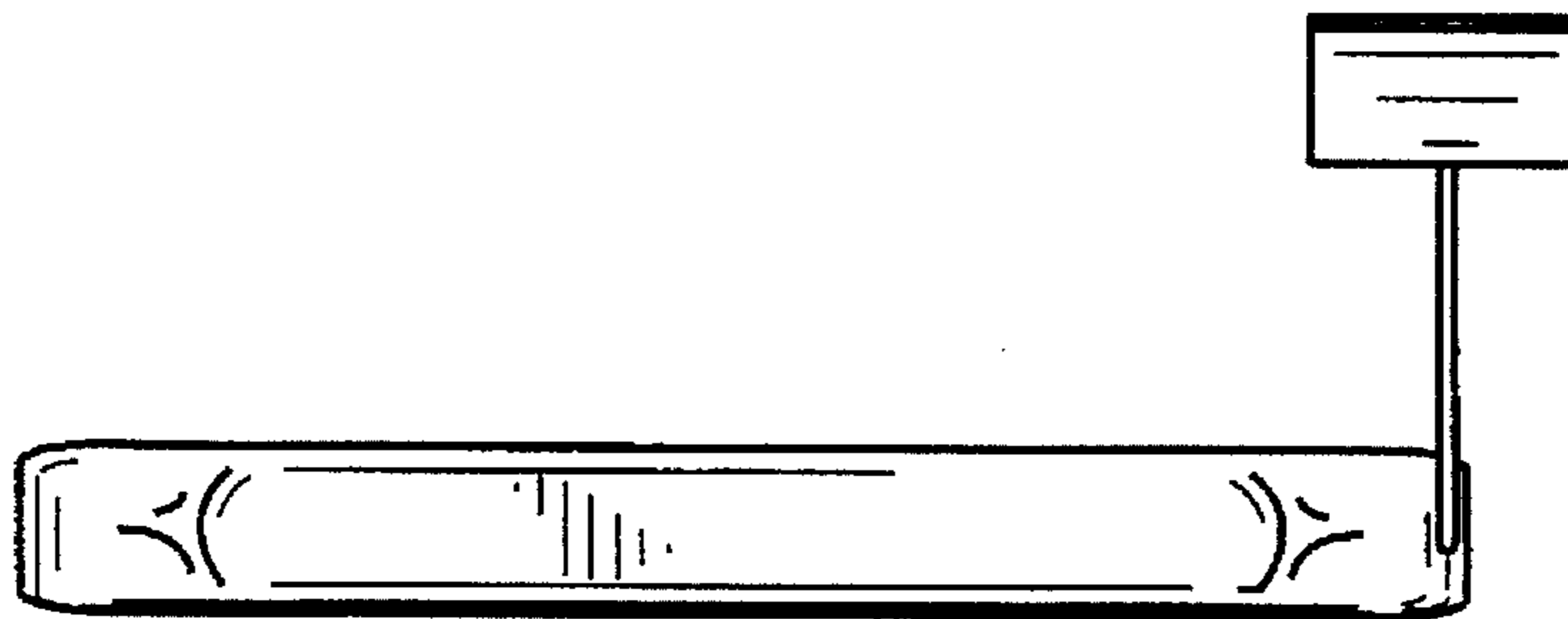

FIG. 6