



US00D376753S

**United States Patent** [19]  
**Nakamura**

[11] **Patent Number: Des. 376,753**

[45] **Date of Patent: \*\*Dec. 24, 1996**

[54] **FOOT MEMBER**

[75] Inventor: **Toshinobu Nakamura**, Tokyo, Japan

[73] Assignee: **Shinagawa Shoko Co., Ltd.**, Tokyo, Japan

[\*\*] Term: **14 Years**

[21] Appl. No.: **50,990**

[22] Filed: **Mar. 1, 1996**

[30] **Foreign Application Priority Data**

Nov. 13, 1995 [JP] Japan ..... 7-33912

[52] **U.S. Cl.** ..... **D8/374**

[58] **Field of Search** ..... D8/374; 248/346.2,  
248/188.1; 16/2, 42 R

[56] **References Cited**

**U.S. PATENT DOCUMENTS**

D. 44,996	12/1913	Buser	.....	D8/374
D. 176,617	1/1956	Kramcsak, Jr.	.....	D8/374
D. 340,638	10/1993	Campbell	.....	D8/374
1,734,727	11/1929	Herold	.....	16/42 R

*Primary Examiner*—Holly H. Baynham  
*Attorney, Agent, or Firm*—Banner & Witcoff, Ltd.

[57] **CLAIM**

The ornamental design for foot member, as shown and described.

**DESCRIPTION**

FIG. 1 is a perspective view of foot member embodying the present design;

FIG. 2 is a front view thereof;

FIG. 3 is a top plan view thereof;

FIG. 4 is a sectional view taken along line 4—4 of FIG. 3;

FIG. 5 is a right side view thereof;

FIG. 6 is a bottom view thereof;

FIG. 7 is a front view thereof without a cover portion;

FIG. 8 is a bottom view thereof without a cover portion;

FIG. 9 is a sectional view taken along line 9—9 of FIG. 8;

FIG. 10 is a front view of the cover portion;

FIG. 11 is a sectional view taken along line 11—11 of FIG. 12;

FIG. 12 is a top plan view of the cover portion;

FIG. 13 is a bottom view of the cover portion; and,

FIG. 14 is an environmental sectional view with the broken line showing of a bolt and a fragmented surface being for illustrative purposes only and forming no part of the claimed design.

The rear view thereof is not shown here as it is a mirror image of the front view.

The left side view thereof is not shown here as it is a mirror image of the right side view.

The elements of the claimed design are shown separately for clarity of illustration.

**1 Claim, 3 Drawing Sheets**

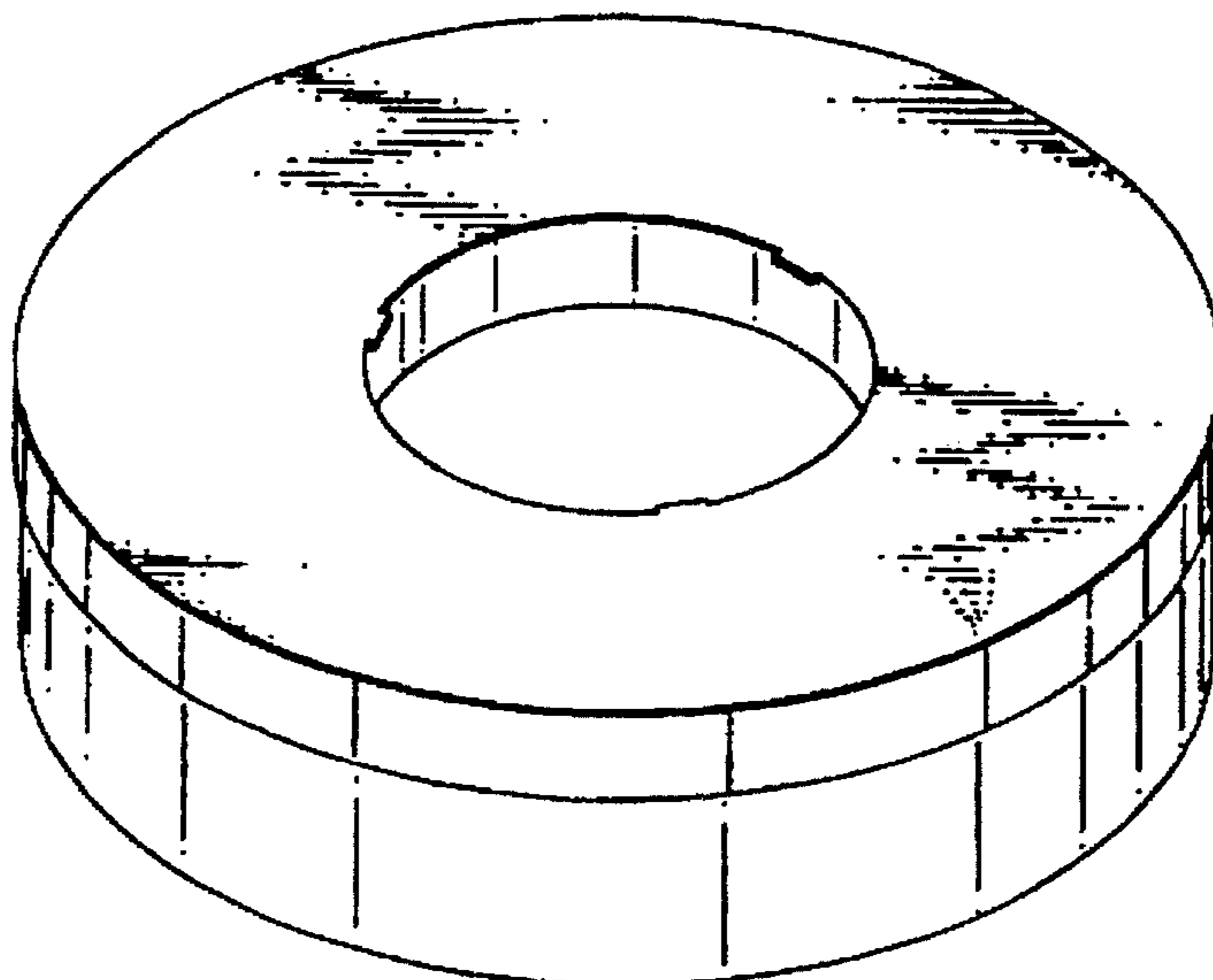

FIG. 1

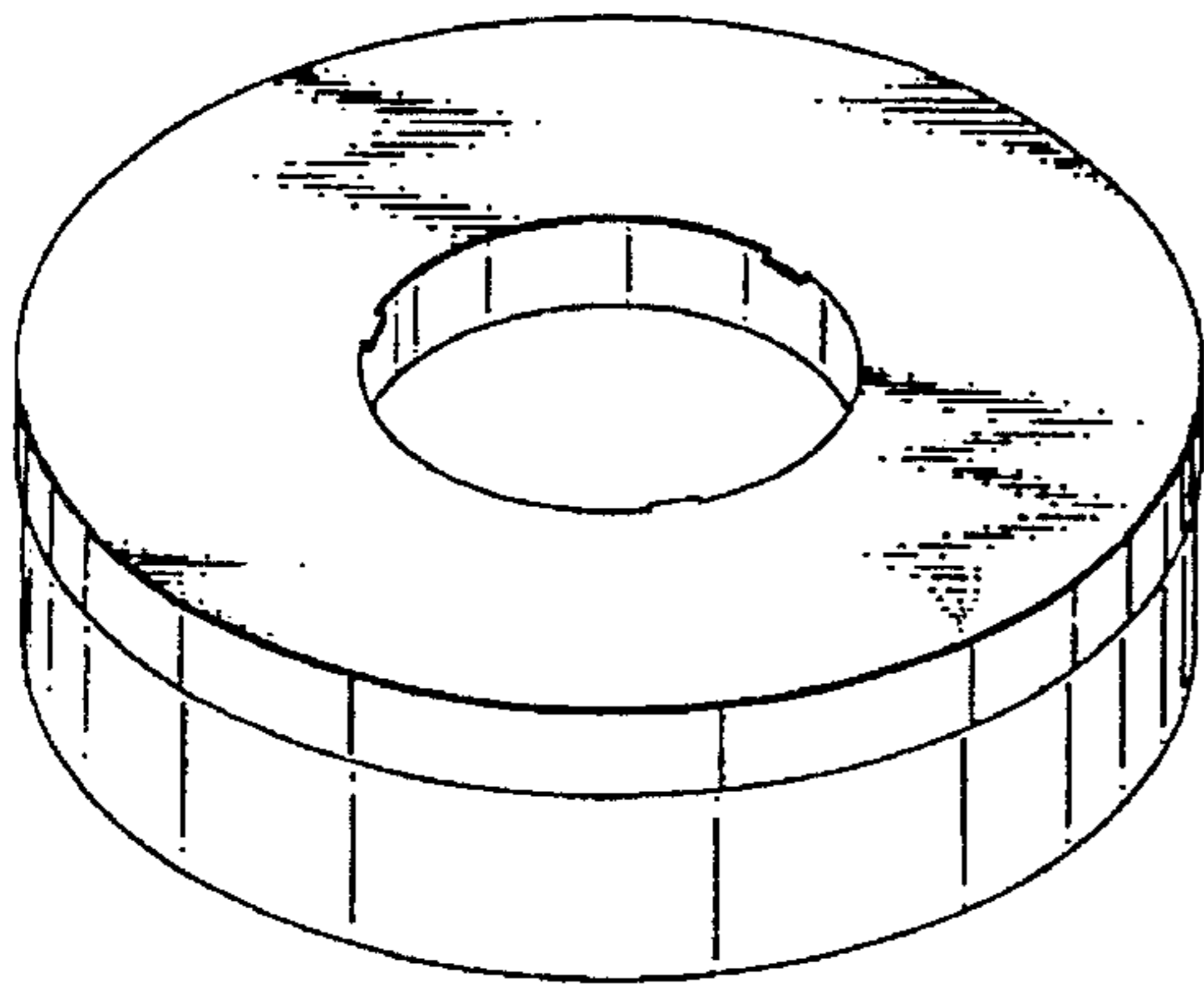

FIG. 4

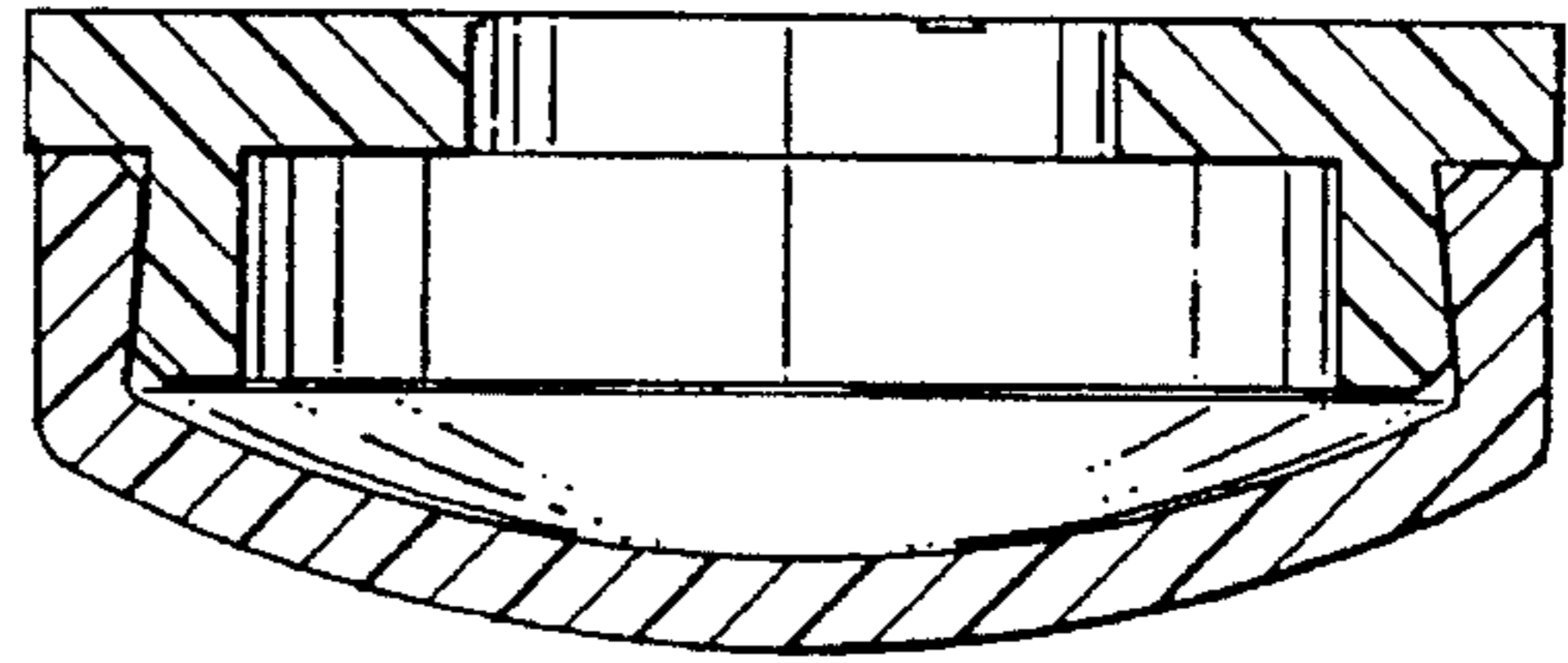

FIG. 2

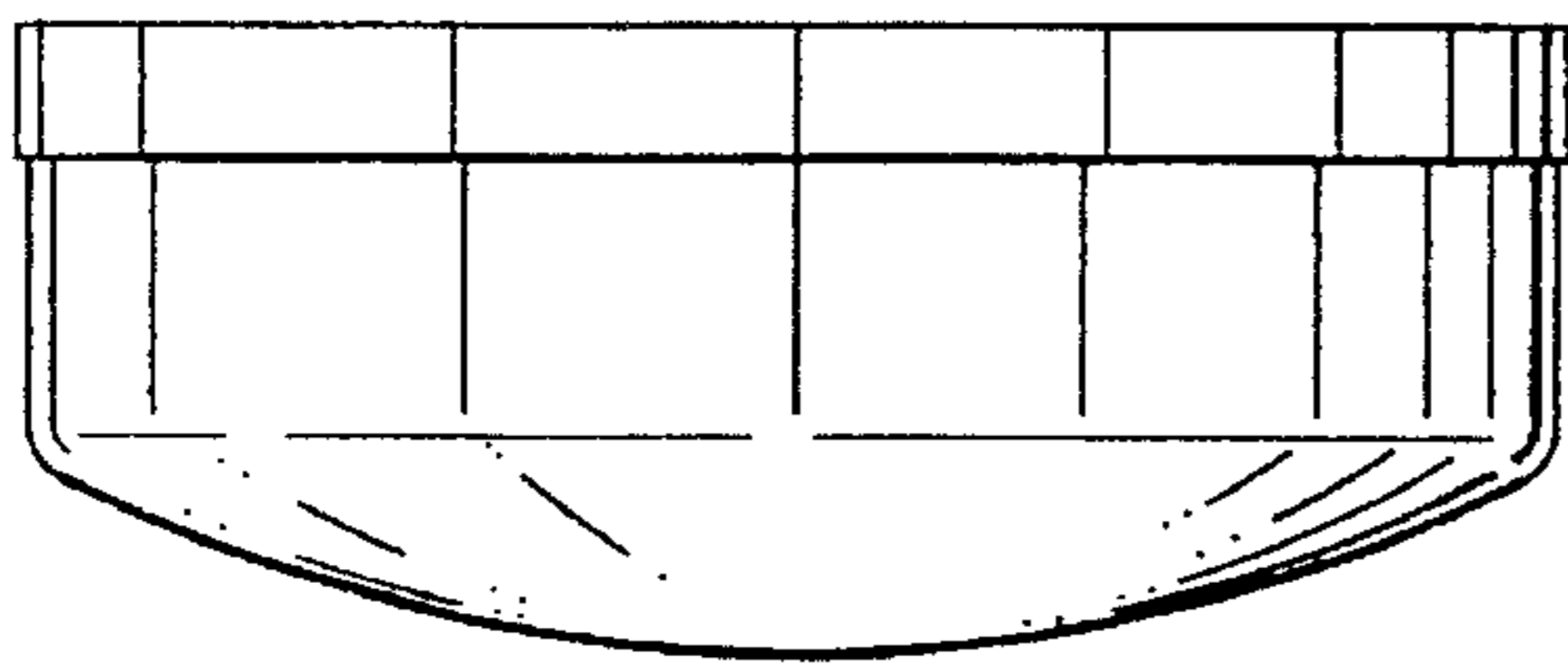

FIG. 5

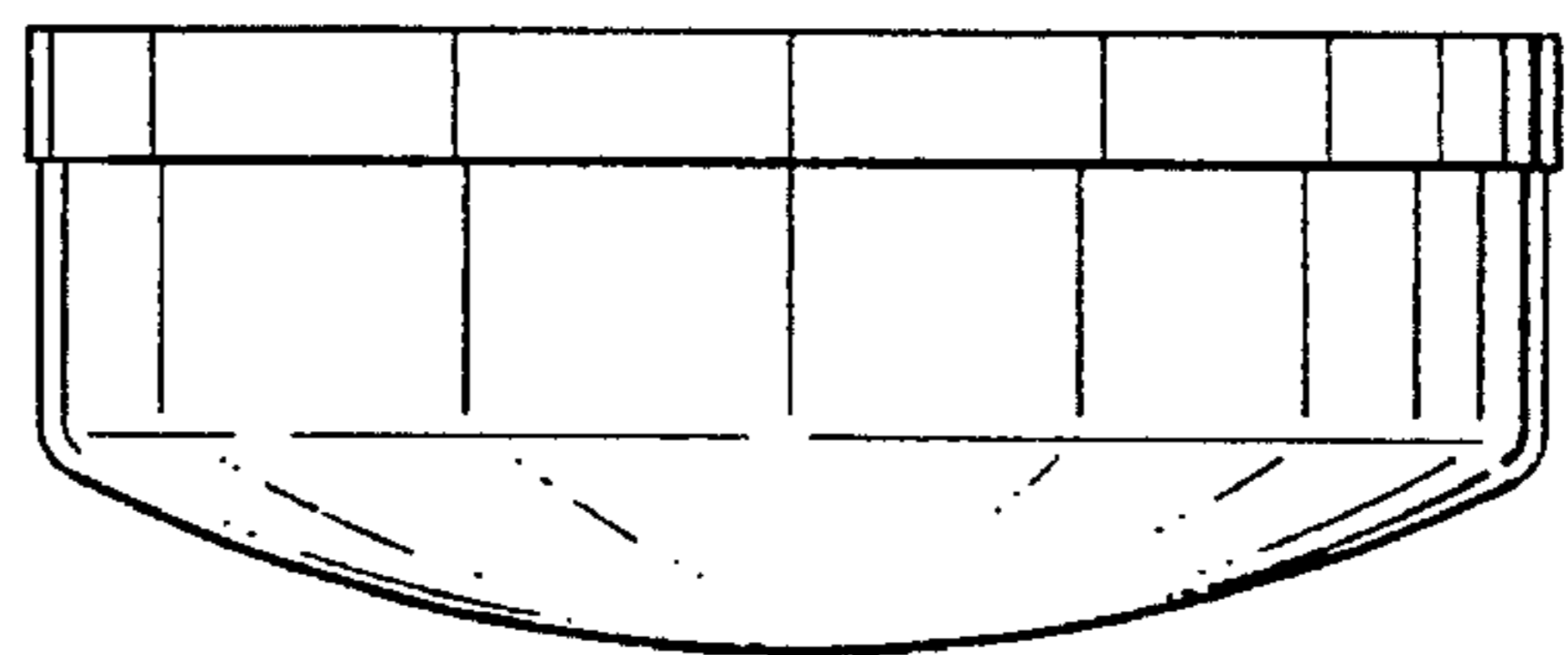

FIG. 3

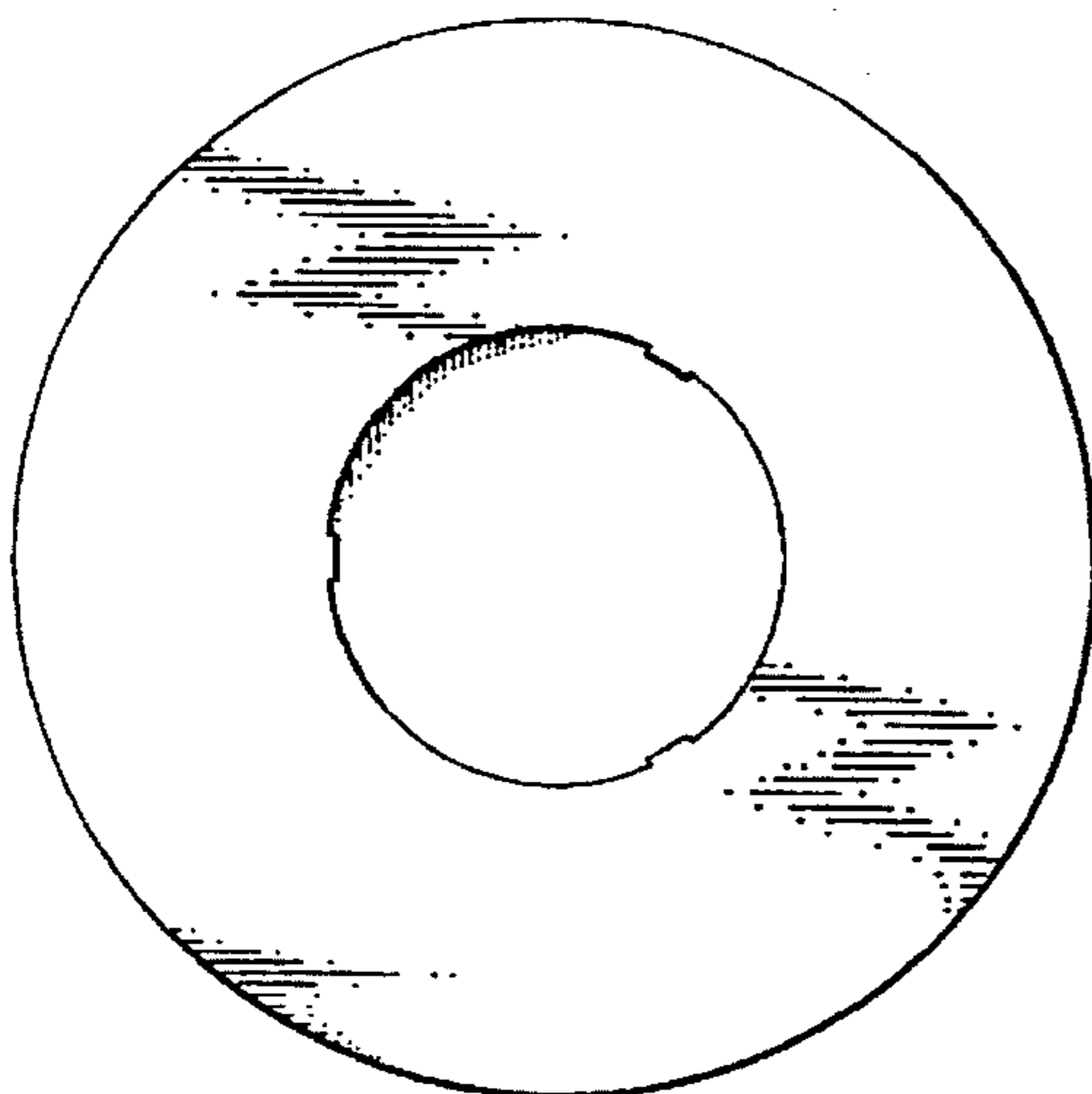

FIG. 6

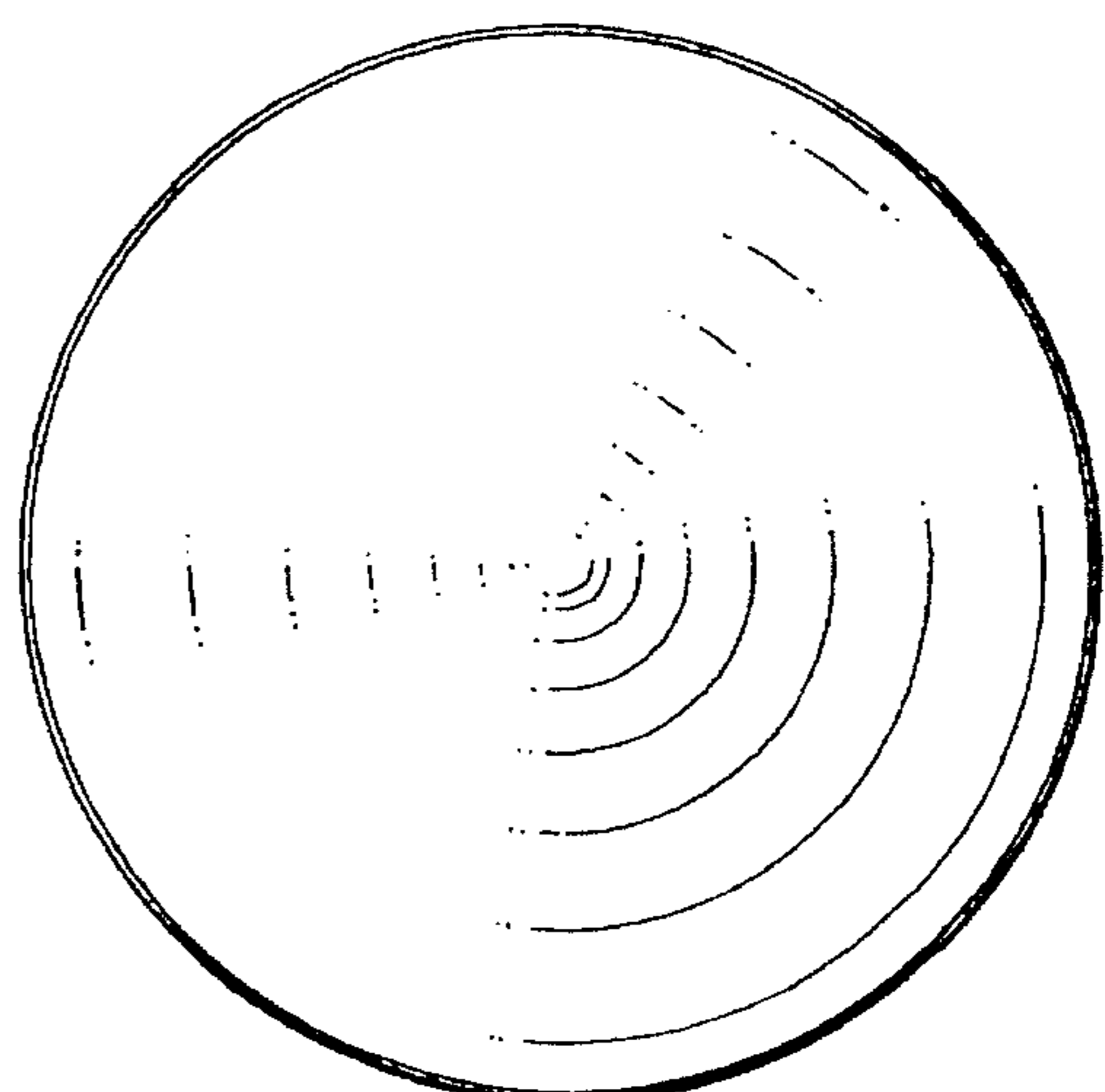

FIG. 7

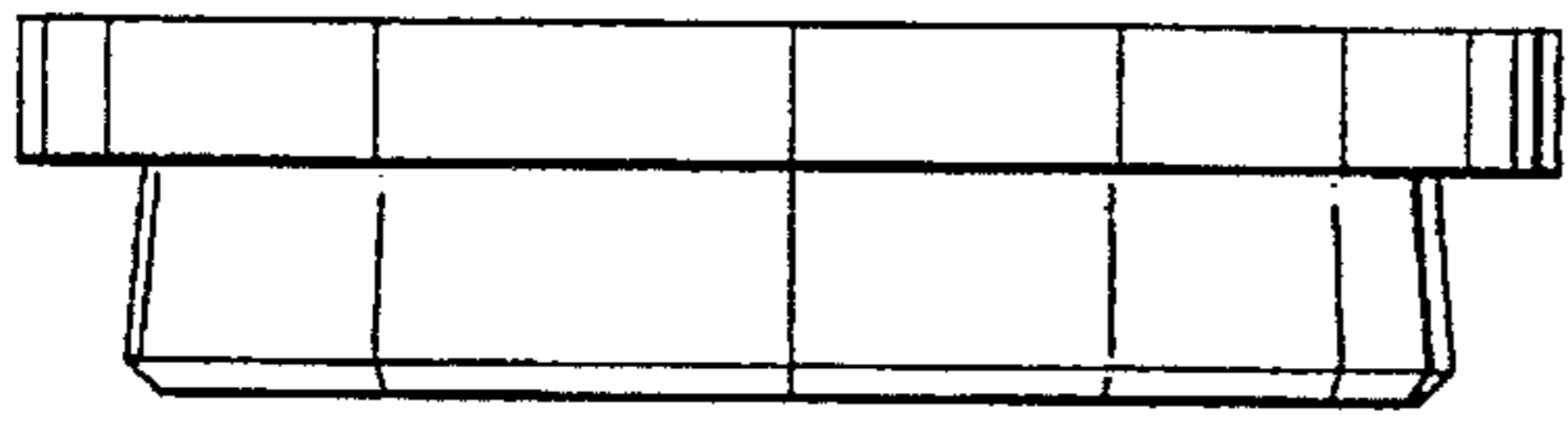

FIG. 8

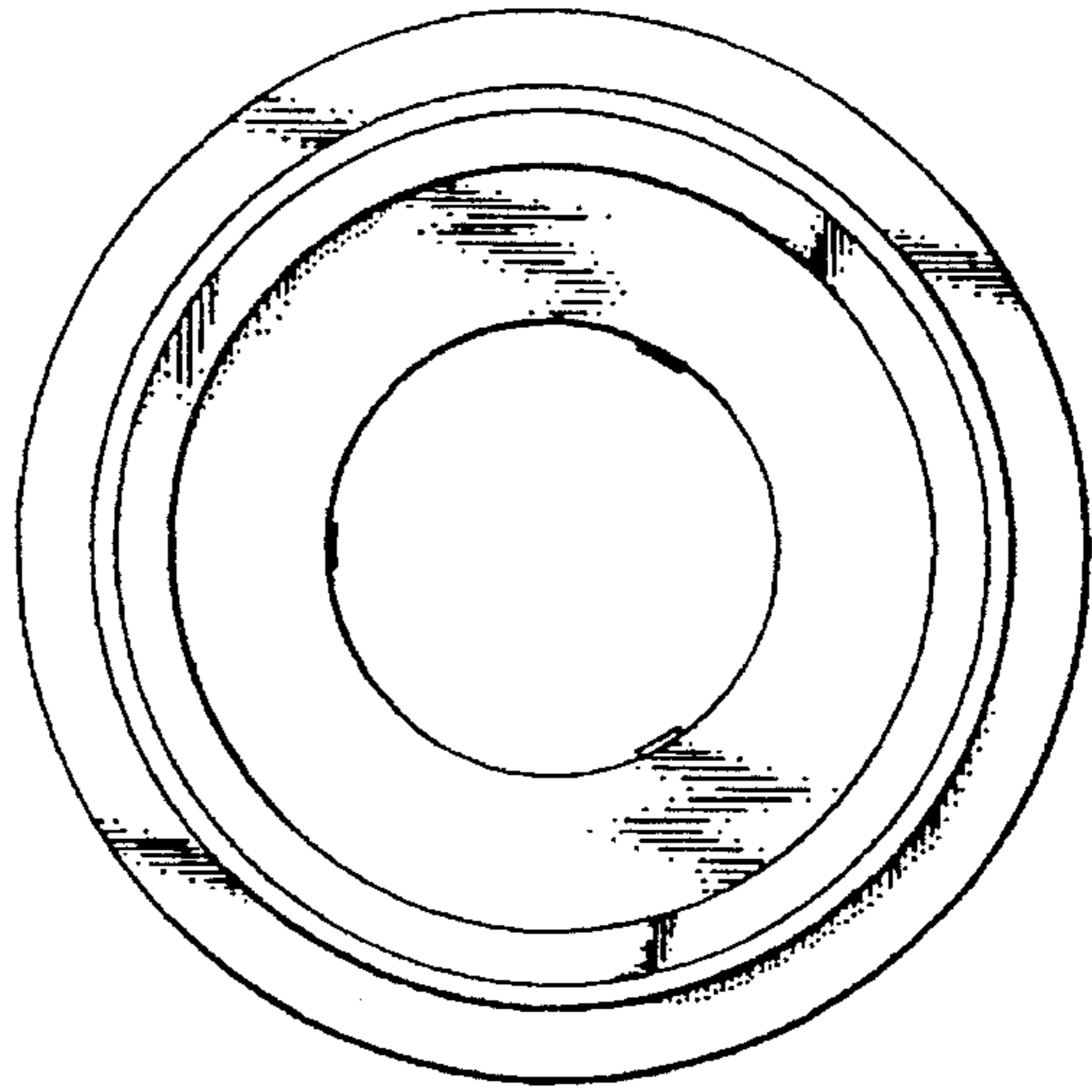

FIG. 9

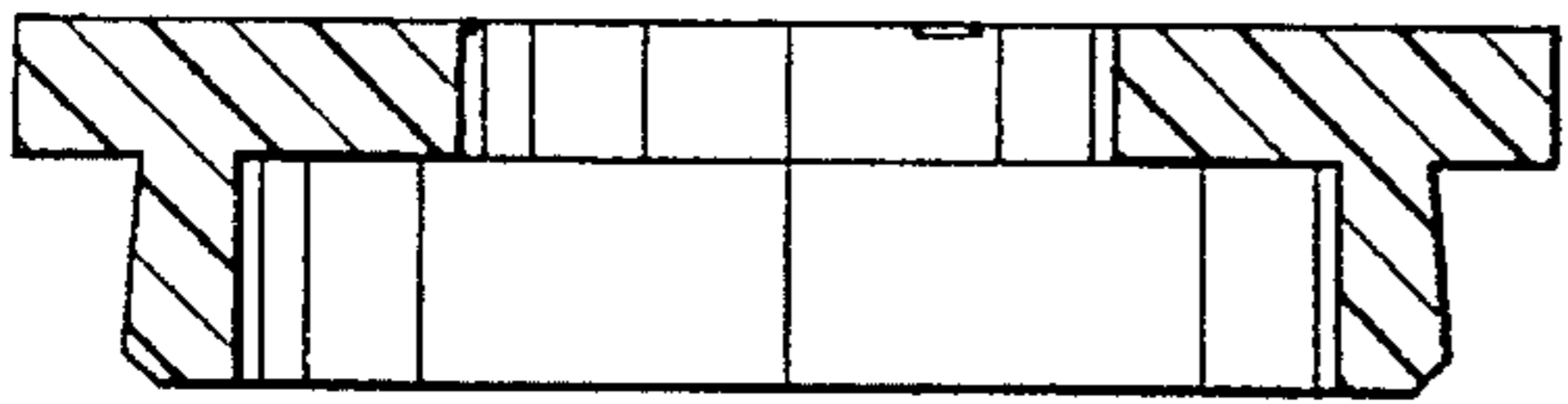

FIG. 10

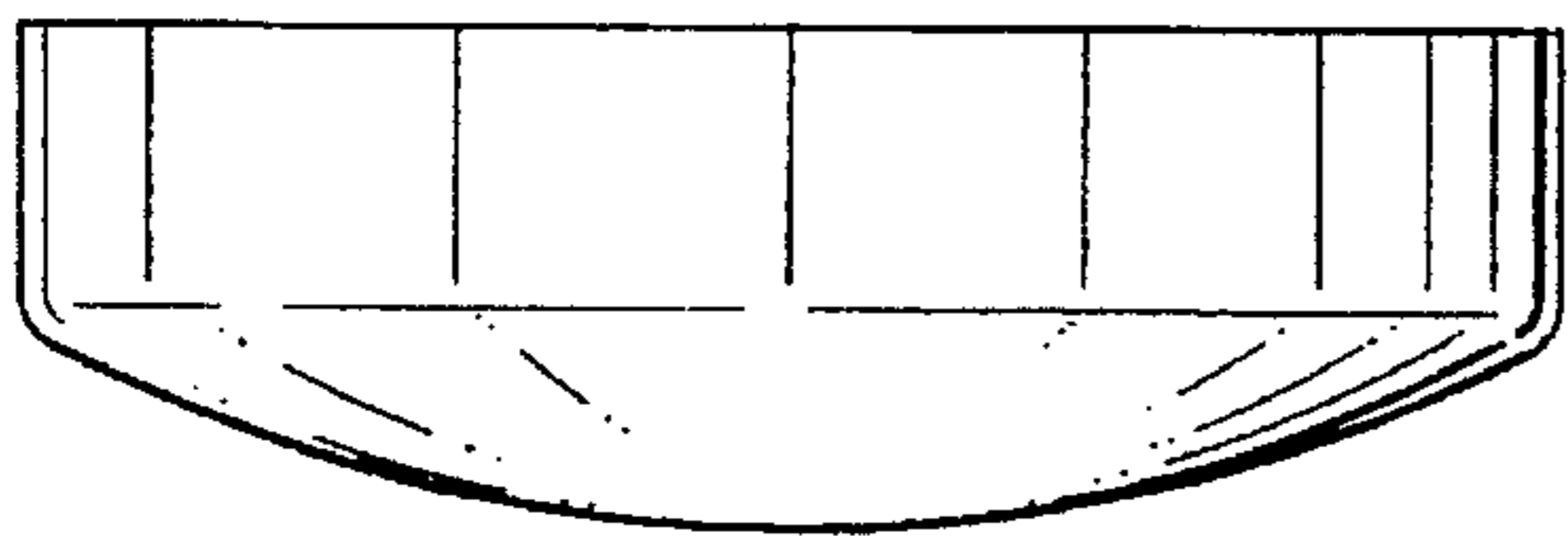

FIG. 11

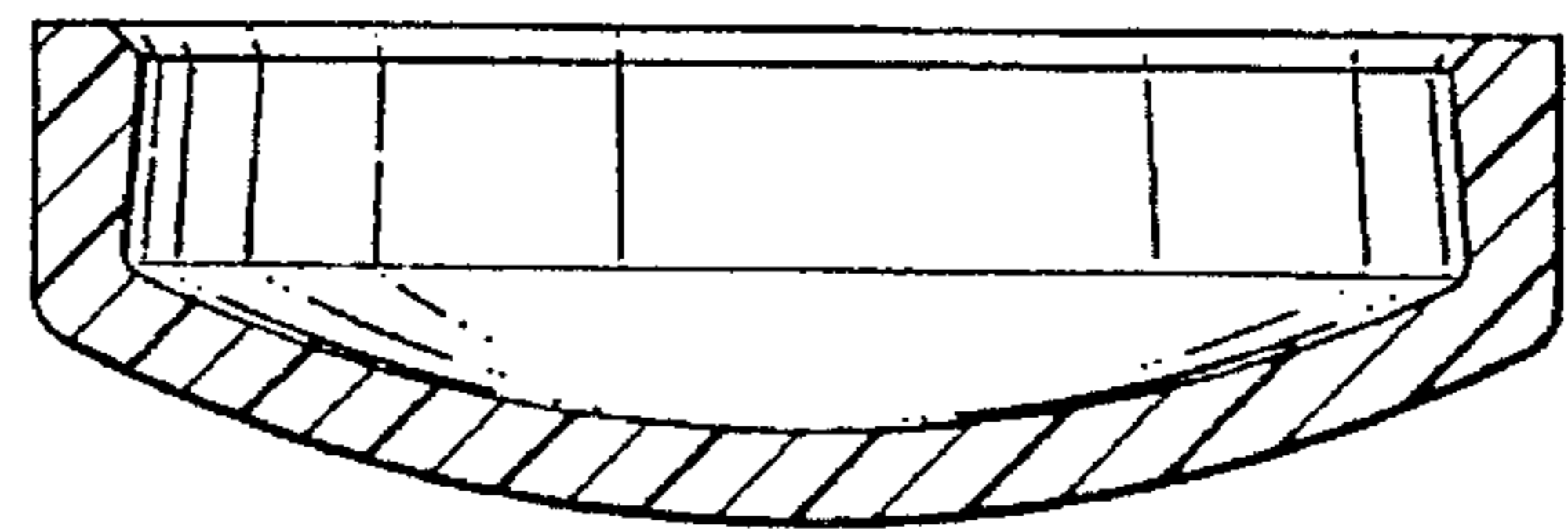

FIG. 12

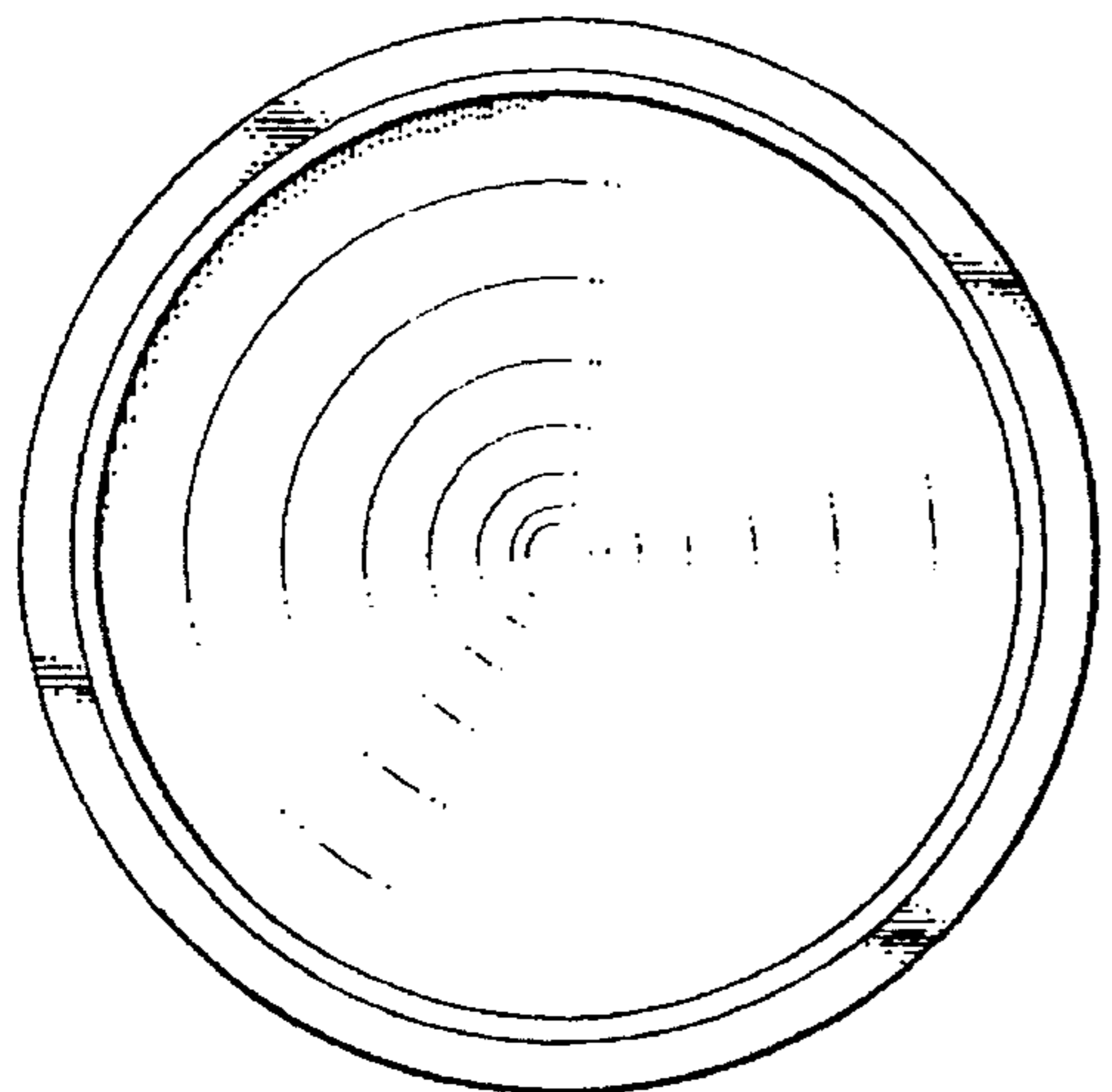

FIG. 13

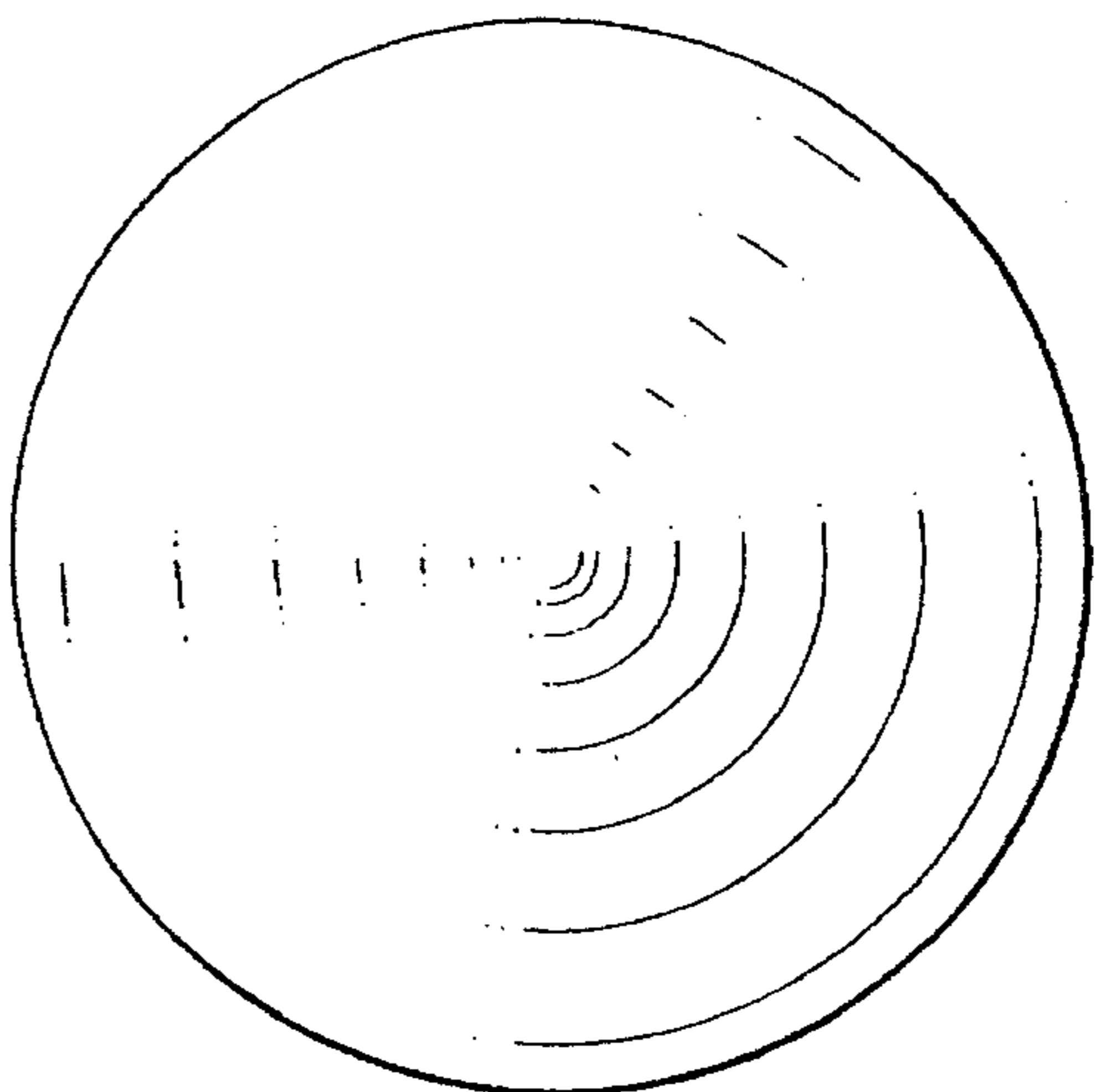

FIG. 14

