



US00D376752S

United States Patent [19]

[11] Patent Number: **Des. 376,752**

Benveniste

[45] Date of Patent: ****Dec. 24, 1996**

[54] **CLEAT FIXABLE TO THE TOE RAIL OF A BOAT FOR ATTACHING A SPRING LINE**

Primary Examiner—Holly H. Baynham
Attorney, Agent, or Firm—ROBIC

[76] Inventor: **Ronald Benveniste**, 3600 Ridgewood, suite 506, Montreal, Quebec, Canada, H3V 1C2

[57] **CLAIM**

The ornamental design for a cleat fixable to the toe rail of a boat for attaching a spring line, as shown and described.

[**] Term: **14 Years**

DESCRIPTION

[21] Appl. No.: **47,006**

FIG. 1 is a front perspective view of a cleat fixable to the toe rail of a boat for attaching a spring line, showing my new design;

[22] Filed: **Nov. 24, 1995**

FIG. 2 is a rear elevational view thereof;

[52] U.S. Cl. **D8/356**

FIG. 3 is a top plan view thereof;

[58] Field of Search D8/354, 356, 382; D12/317

FIG. 4 is a front elevational view thereof;

[56] References Cited

U.S. PATENT DOCUMENTS

- D. 316,664 5/1991 Tull D12/317 X
- D. 332,932 2/1993 Nichols et al. D12/317
- D. 338,119 8/1993 Merrick D6/491 X

OTHER PUBLICATIONS

The Rudder, Oct. 1962, p. 84, bracket item A, located at top of page.

J. C. Whitney Catalog, Mar. 2, 1992, p. 162, motor mounts item A located at bottom of page.

1 Claim, 3 Drawing Sheets

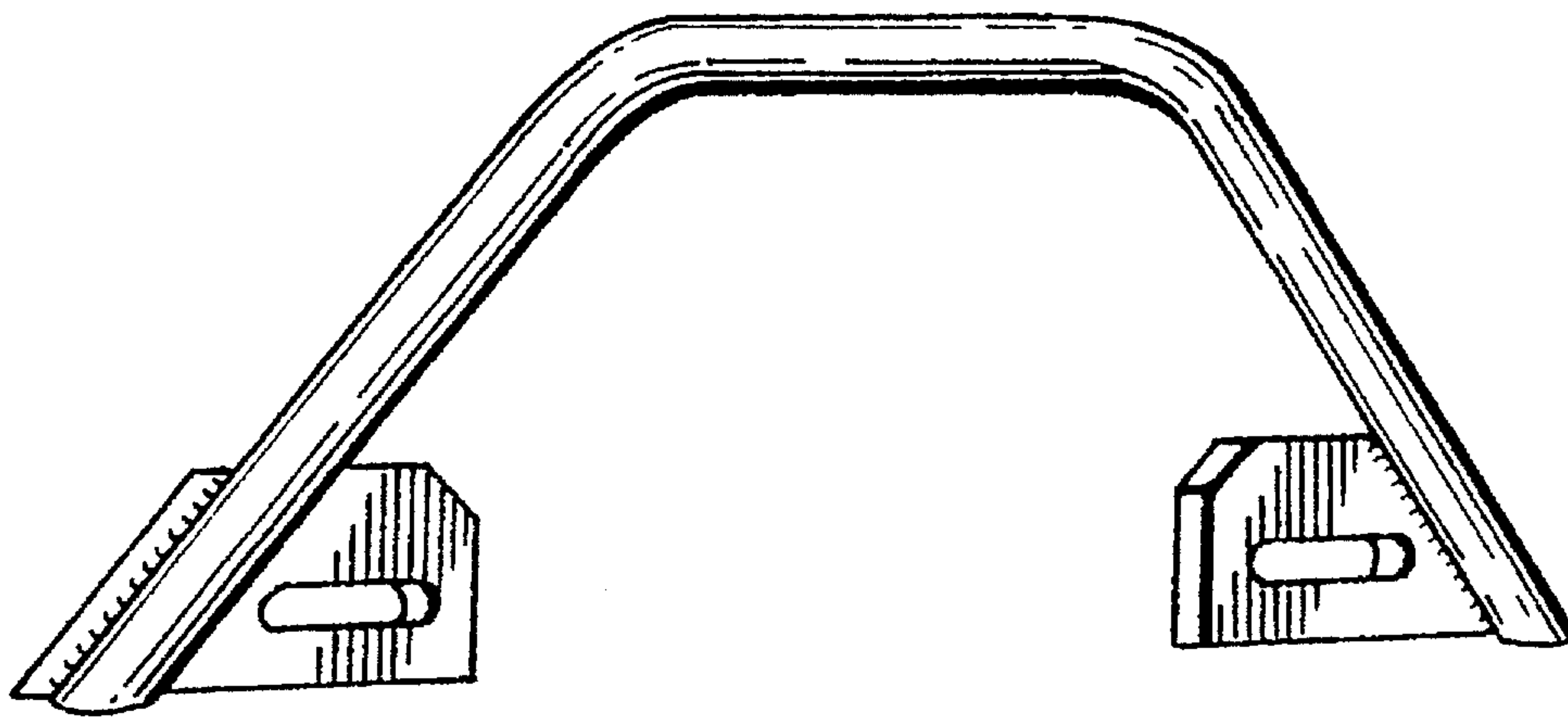

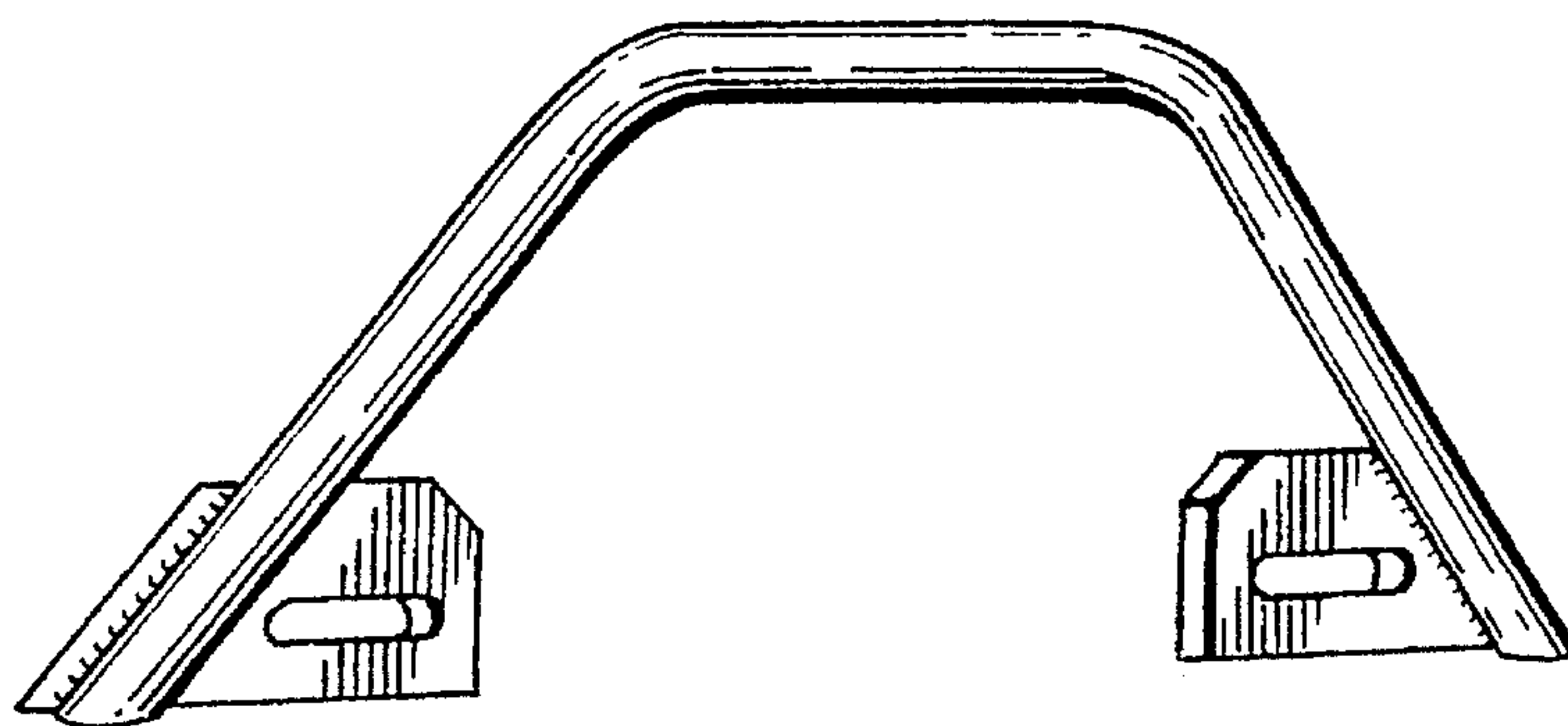

FIG. 1

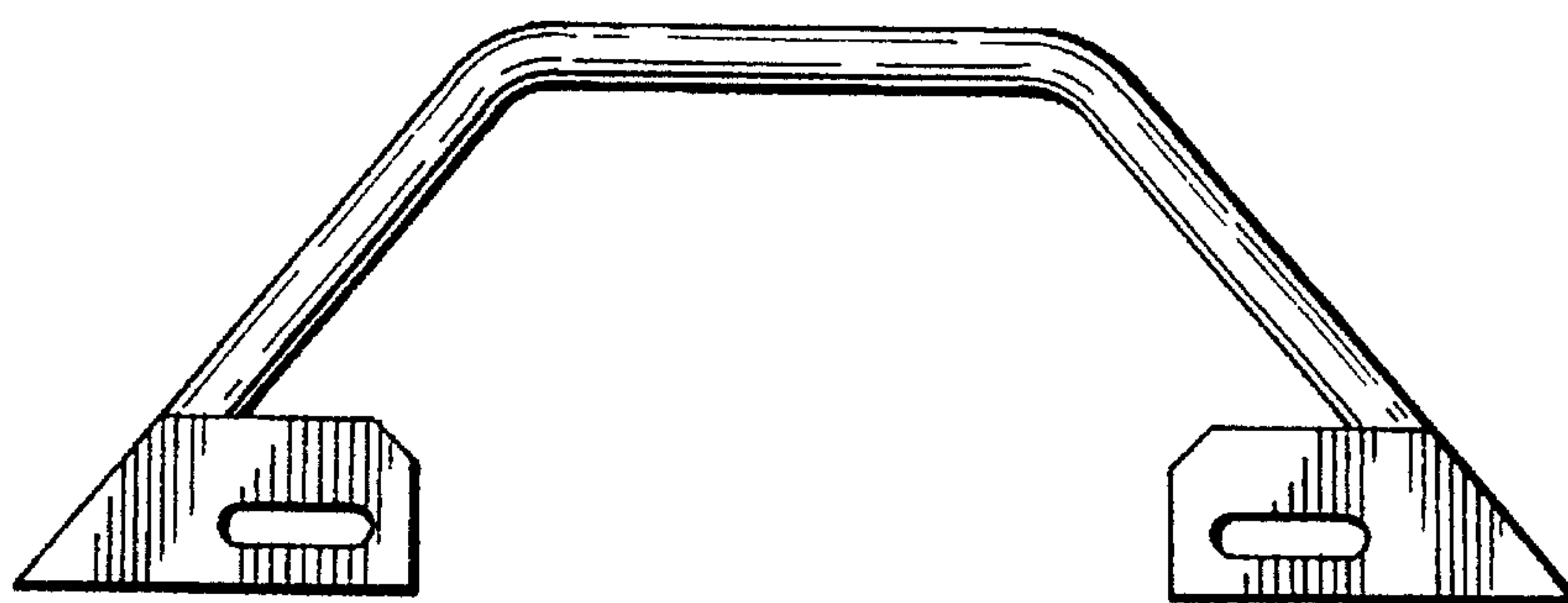

FIG. 2

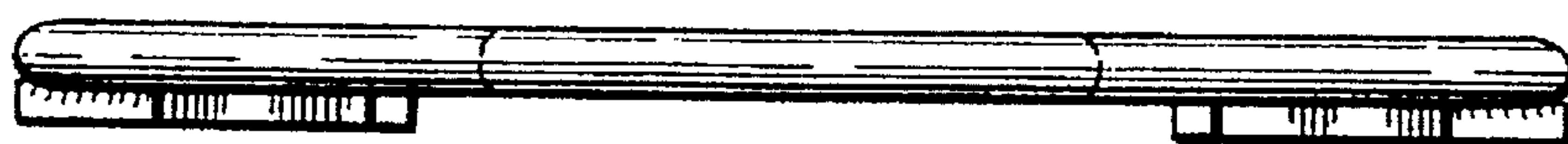

FIG. 3

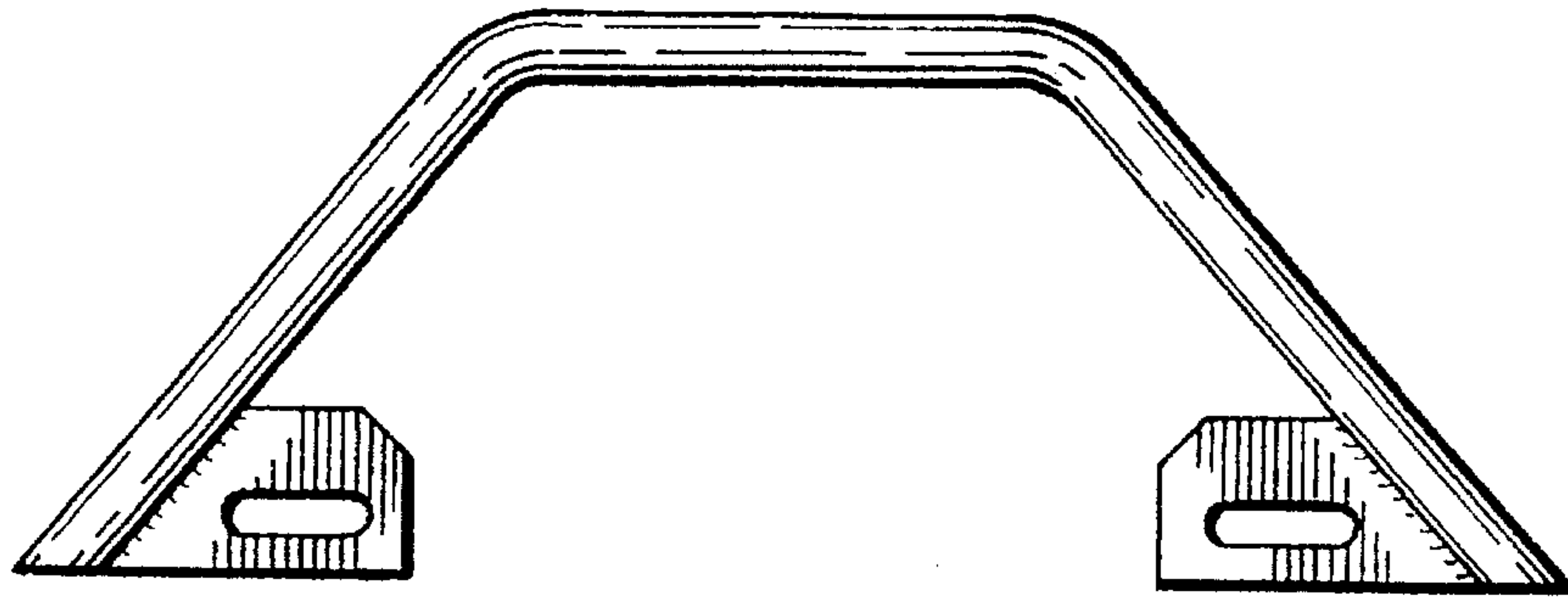

FIG. 4

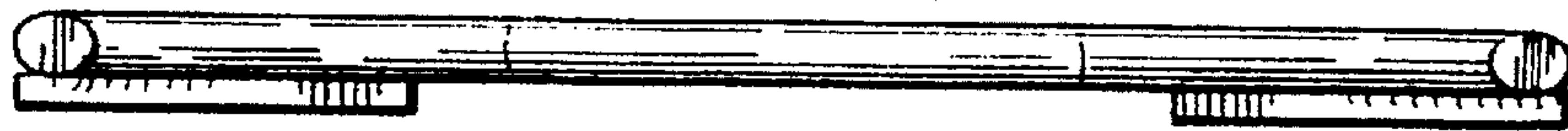

FIG. 5



FIG. 6

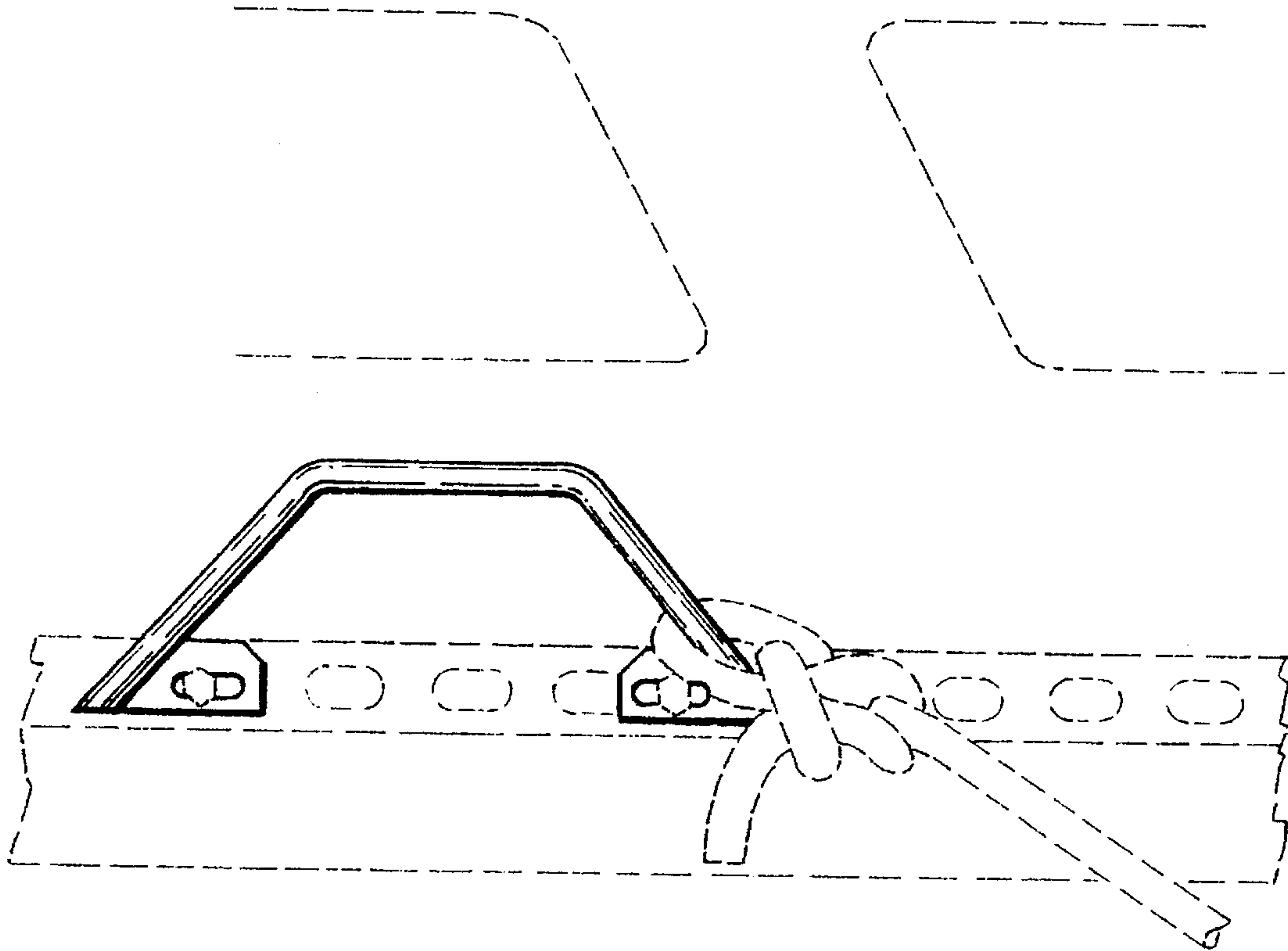

FIG. 7