



US00D376697S

# United States Patent [19]

[11] Patent Number: **Des. 376,697**

Green et al.

[45] Date of Patent: **\*\*Dec. 24, 1996**

[54] **COMBINED CONTAINER AND APPLICATOR**

5,299,877 4/1994 Birden ..... 401/206

[76] Inventors: **Carl E. Green; Alexandra R. Green,**  
both of 322 S. Hamilton, Lincoln, Ill.  
62656

*Primary Examiner*—A. Hugo Word  
*Assistant Examiner*—Lavone D. Tabor

[\*\*] Term: **14 Years**

[57] **CLAIM**

The ornamental design for a combined container and applicator, as shown and described.

[21] Appl. No.: **37,887**

**DESCRIPTION**

[22] Filed: **Apr. 24, 1995**

[52] U.S. Cl. .... **D4/114; D4/116; D9/338;**  
D9/543

[58] **Field of Search** ..... D4/114, 116, 127,  
D4/137; D9/337, 338, 523, 530, 560, 563,  
572, 573, 300, 542, 543; 401/136, 137,  
152, 156, 183–185, 196, 205–207, 261,  
264–266

FIG. 1 is a front elevational view of the combined container and applicator showing our new design; FIG. 2 is a rear elevational view thereof; FIG. 3 is a left side elevational view thereof; FIG. 4 is a right side elevational view thereof; FIG. 5 is a top plan view thereof; FIG. 6 is a bottom plan view thereof; and, FIG. 7 is an isometric view thereof.

[56] **References Cited**

The crosshatching that is shown on the applicator represents a conventional material and is understood to continue throughout the areas indicated. The broken line showing of a label is for illustrative purposes only and forms no part of the claimed design.

**U.S. PATENT DOCUMENTS**

- D. 206,194 11/1966 Gooding ..... D9/542
- D. 208,174 7/1967 Carveth ..... D9/338
- 2,820,234 1/1958 Rigney ..... 401/207 X

**1 Claim, 4 Drawing Sheets**

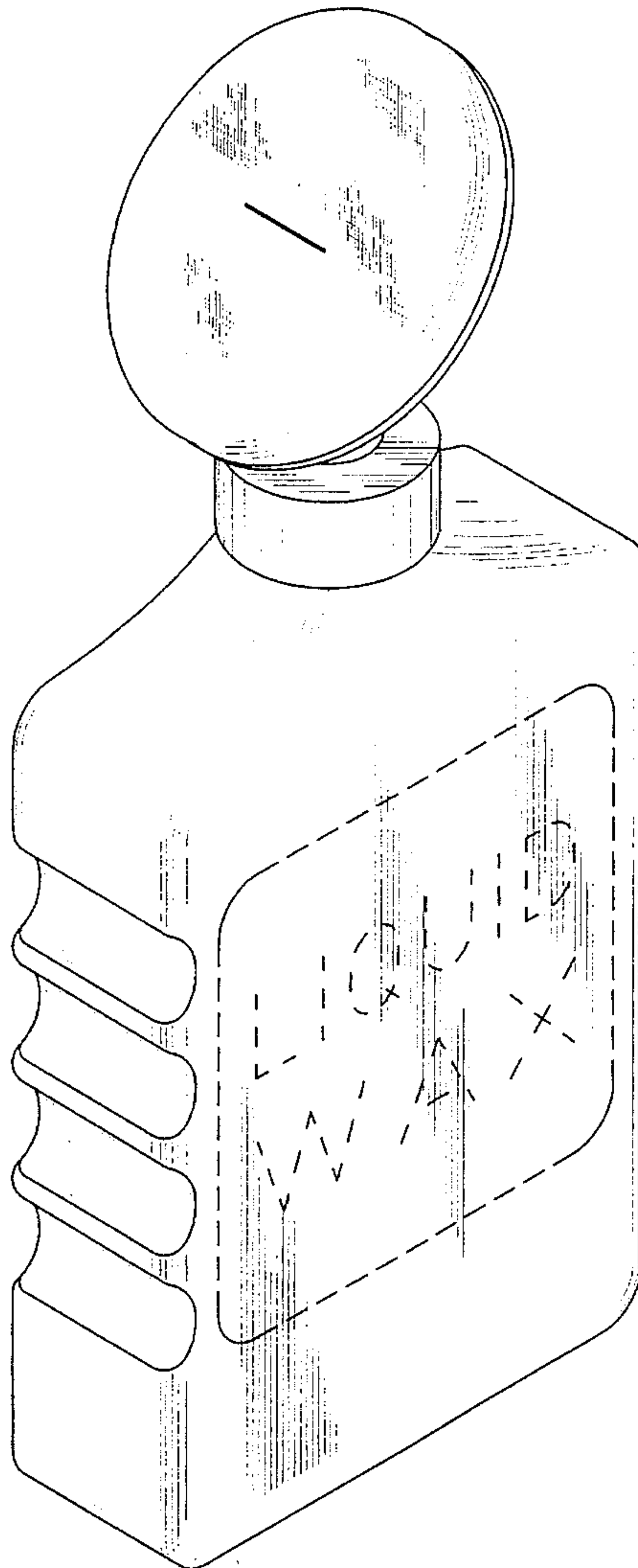

FIG. 1

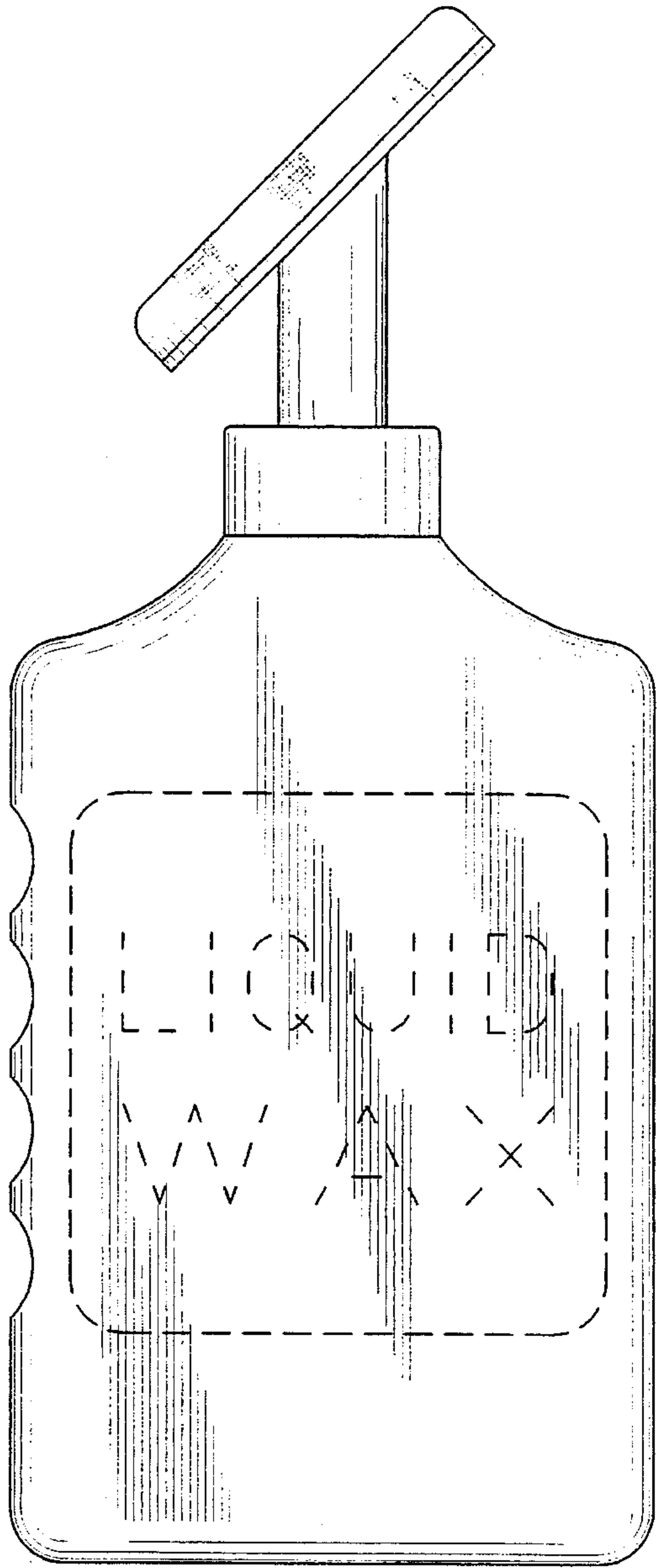

FIG. 2

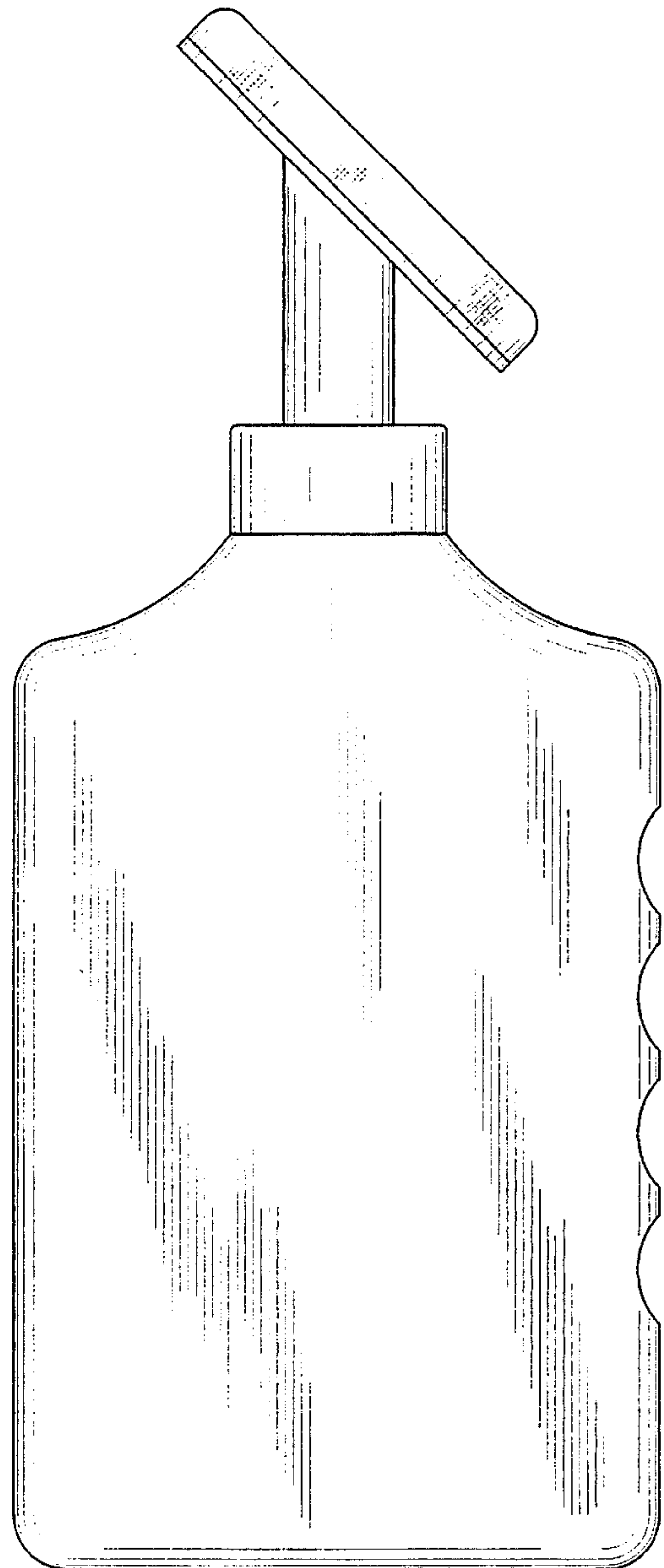

FIG. 3

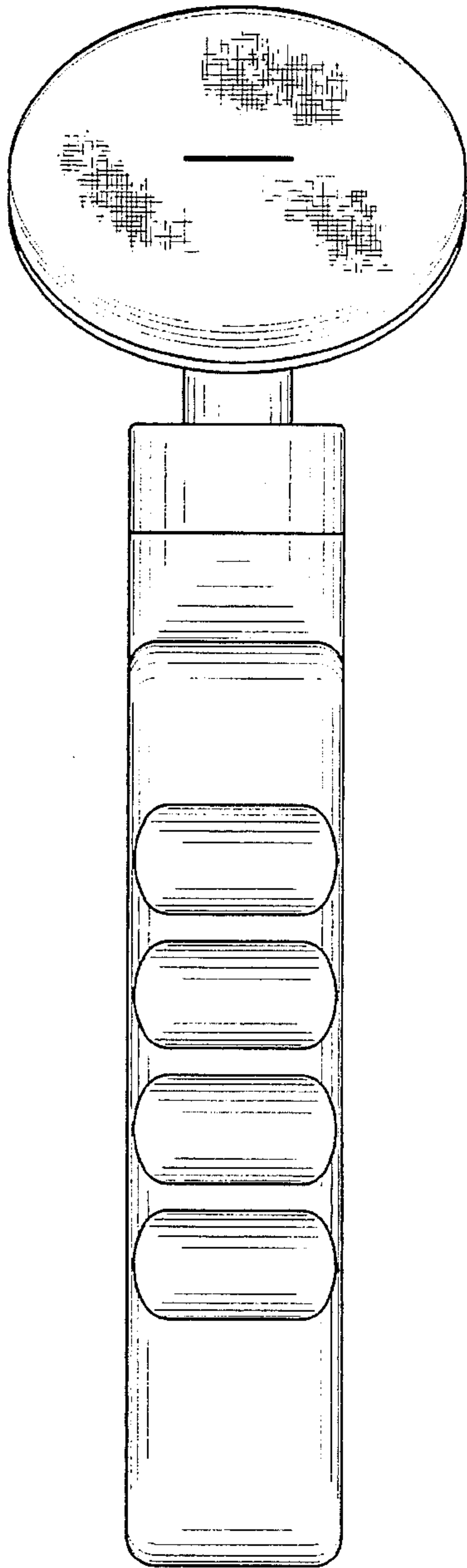

FIG. 4

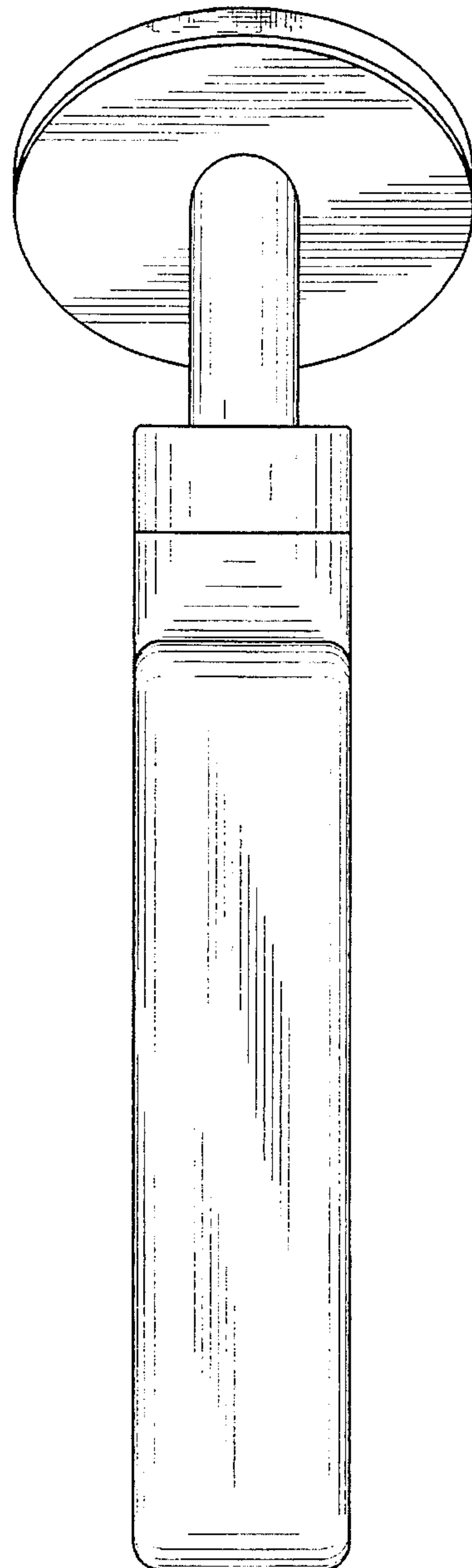

FIG. 5

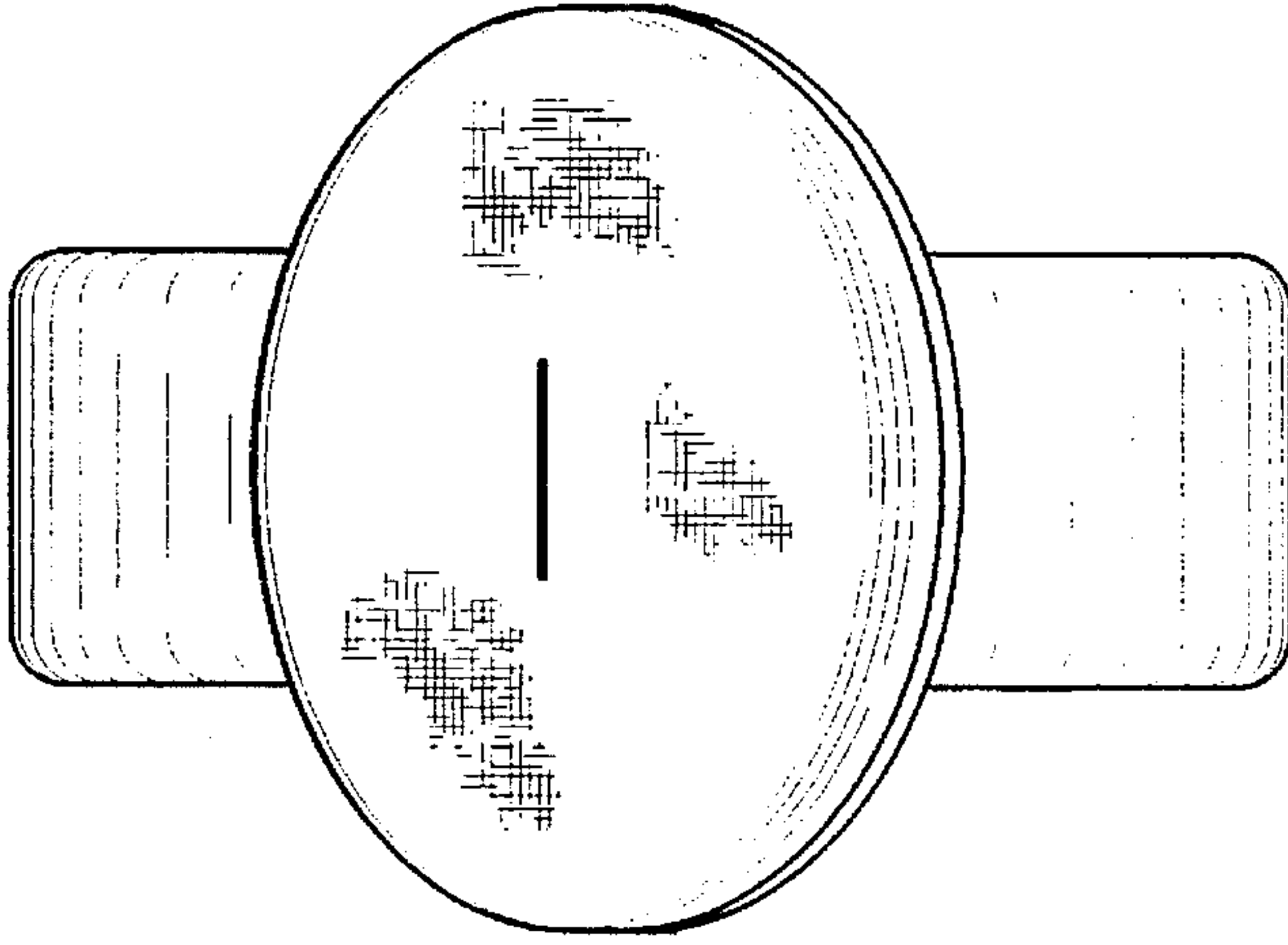

FIG. 6

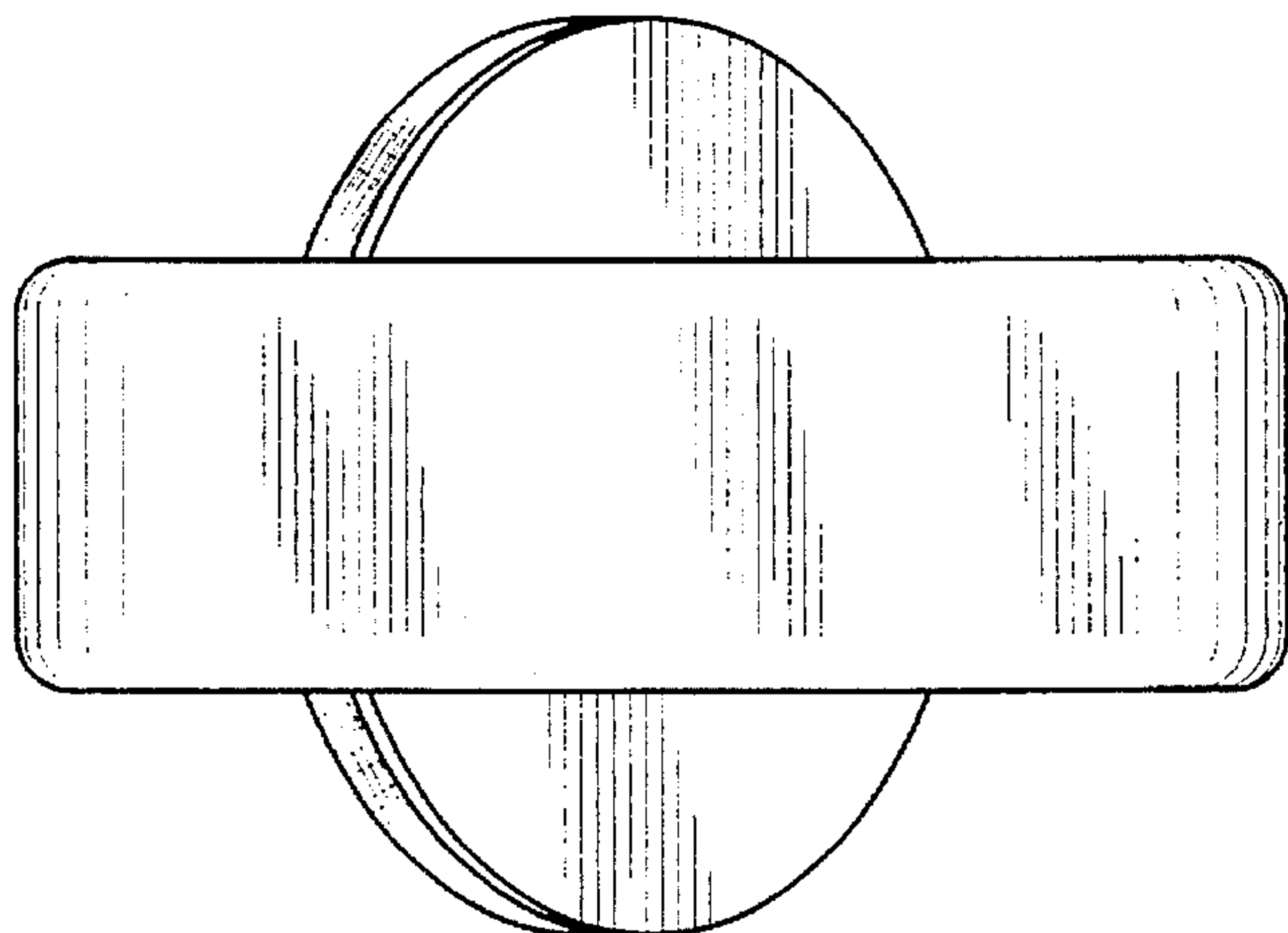

FIG. 7

