



US00D376690S

United States Patent [19]

Lockerby

[11] Patent Number: **Des. 376,690**

[45] Date of Patent: ****Dec. 24, 1996**

[54] **BATTERY STORAGE CASE HAVING A FOAM INSERT FOR RECEIVING A PLURALITY OF DIFFERENT SIZED BATTERIES**

D. 343,289	1/1994	Duley	D3/284
D. 347,729	6/1994	Bible, Jr.	D3/274
4,671,405	6/1987	Hagan	220/507
4,887,790	12/1989	Wilkinson et al.	220/507

[76] Inventor: **Andrew J. Lockerby**, 11 Rosenfeld Rd., Millis, Mass. 02054

Primary Examiner—Philip S. Hyder

[**] Term: **14 Years**

[57] **CLAIM**

[21] Appl. No.: **50,171**

The ornamental design for a battery storage case having a foam insert for receiving a plurality of different sized batteries, as shown and described.

[22] Filed: **Feb. 9, 1996**

DESCRIPTION

[52] U.S. Cl. **D3/284; D3/294; D3/295; D3/273**

FIG. 1 is a front elevational view of the battery storage case having a foam insert for receiving a plurality of different sized batteries showing my new design; FIG. 2 is a rear elevational view thereof; FIG. 3 is a right view thereof; FIG. 4 is a left view thereof; FIG. 5 is a top plan view thereof; FIG. 6 is a bottom plan view thereof; and, FIG. 7 is an isometric view thereof of the storage case in the open orientation illustrating the plurality of different sized battery apertures.

[58] **Field of Search** D3/294, 295, 284, D3/295, 313, 283; 220/500, 503, 520, 522, 507, 512; 206/541, 372, 316.1; D9/424; 190/110, 111, 112, 113, 114, 115

[56] **References Cited**

U.S. PATENT DOCUMENTS

D. 256,522	8/1980	Peterson	D3/284
D. 275,833	10/1984	Malpass	D9/424
D. 341,027	11/1993	Godden et al.	D3/274

1 Claim, 4 Drawing Sheets

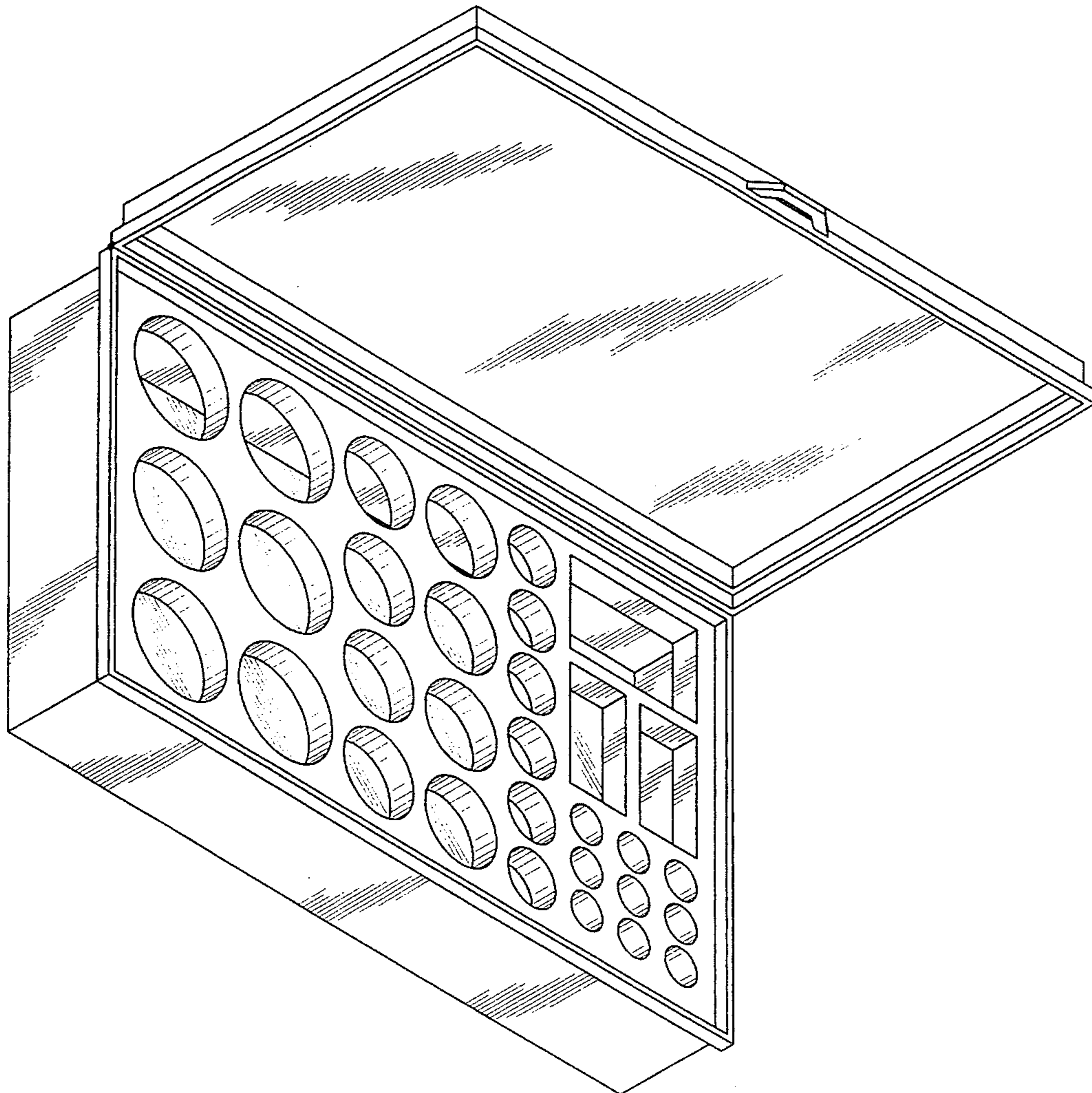

FIG. 1

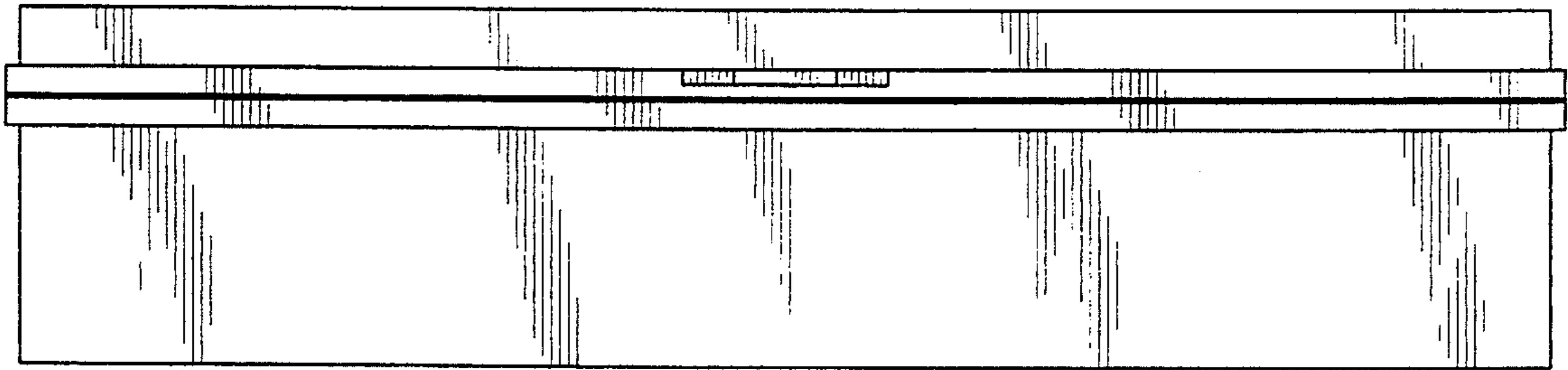

FIG. 2

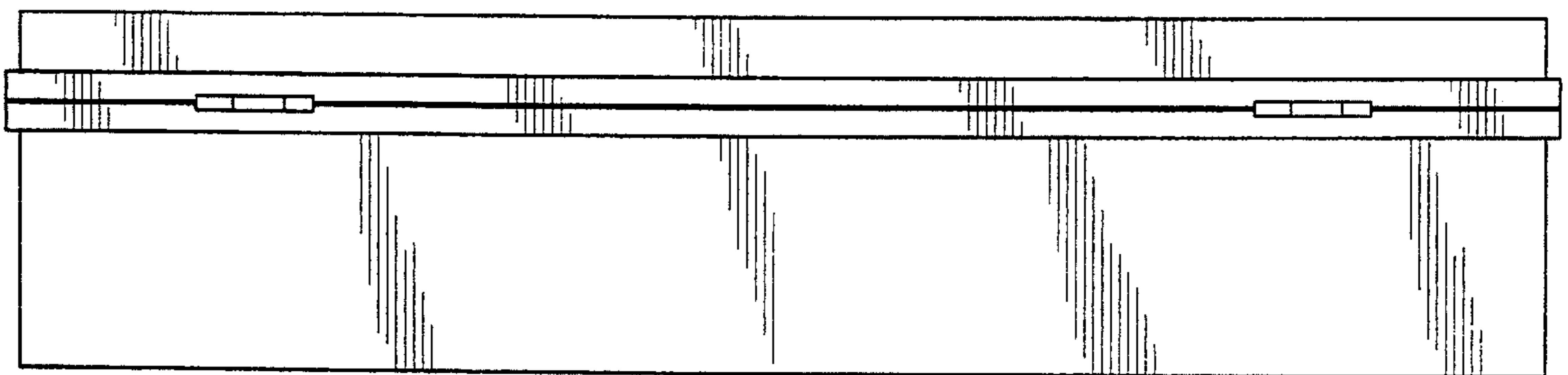

FIG. 3

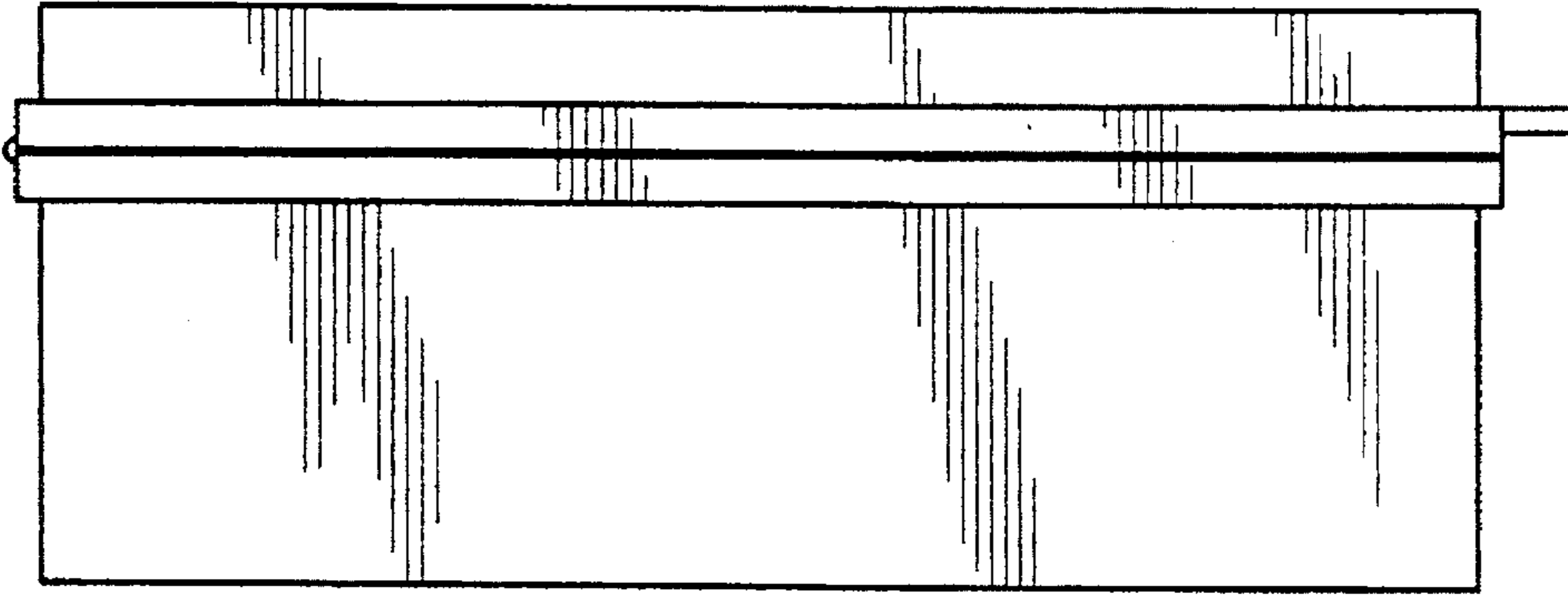

FIG. 4

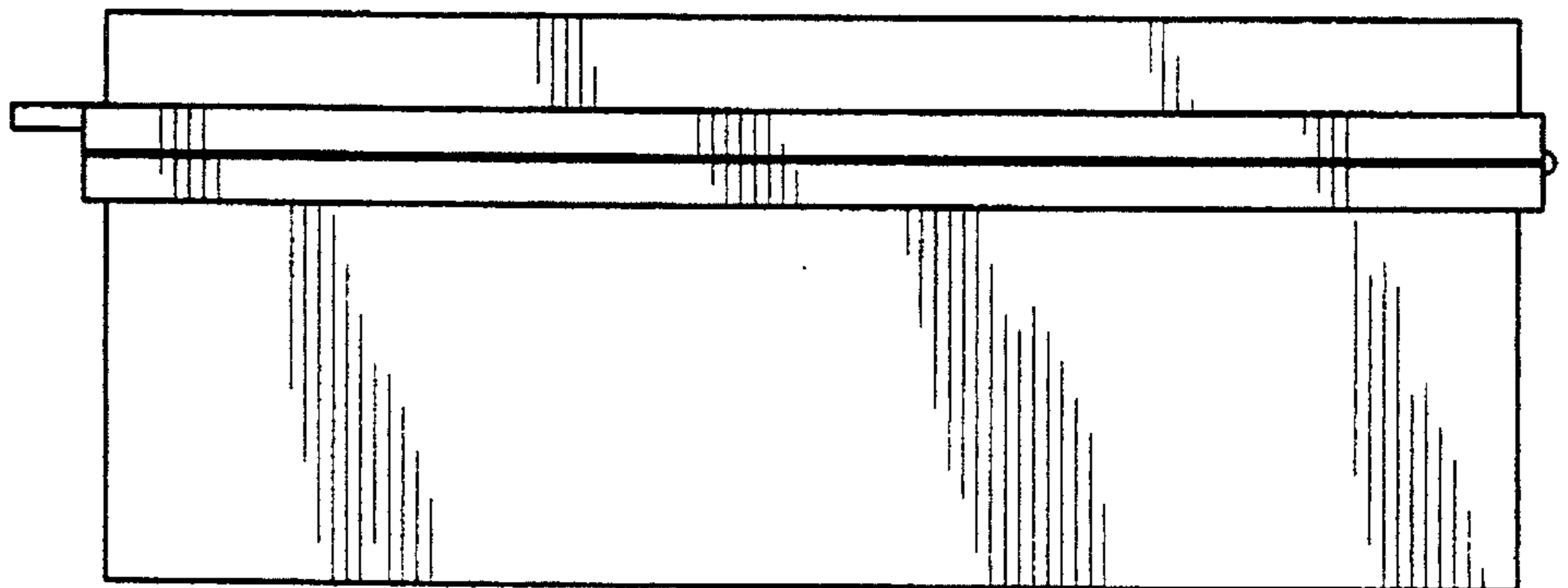

FIG. 5

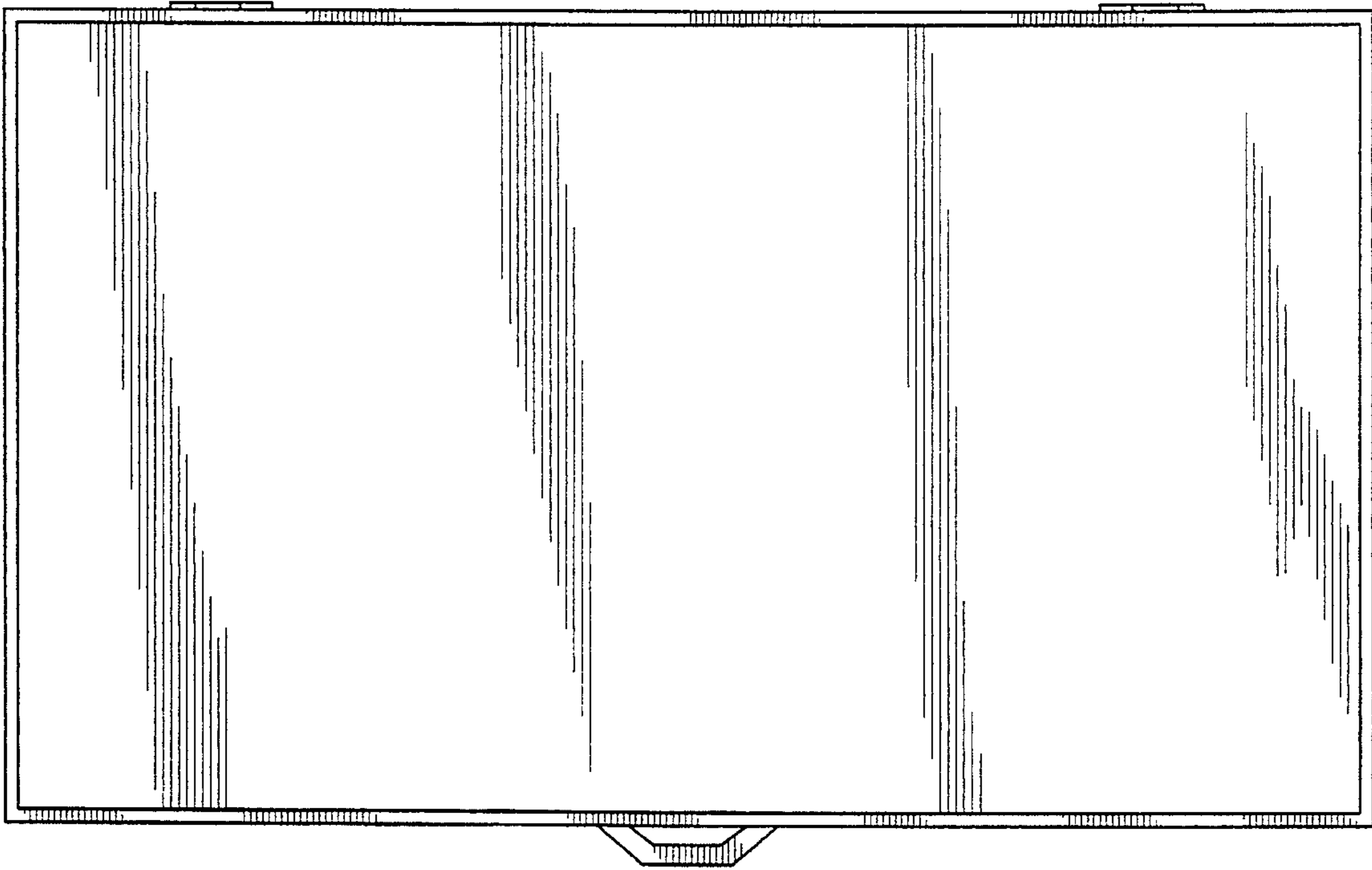

FIG. 6

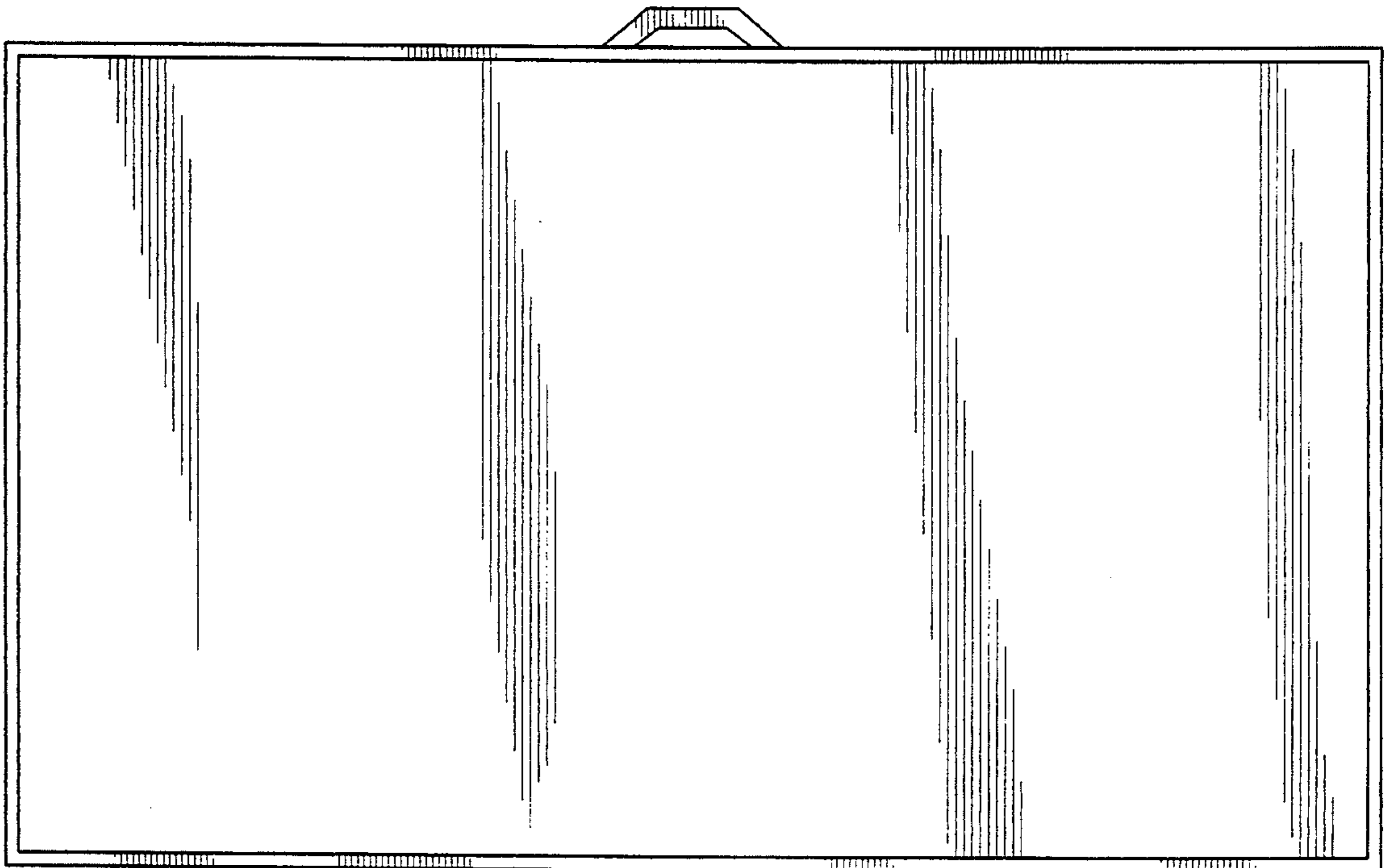

FIG. 7

