



US00D376685S

United States Patent [19]

[11] Patent Number: **Des. 376,685**

Weller et al.

[45] Date of Patent: ****Dec. 24, 1996**

[54] **PAINTED GLASS PILL CONTAINER WITH ATTACHABLE MOUNTING PLATE**

4,905,213	2/1990	Masse et al.	368/10
5,102,023	4/1992	Nguyen	224/903 X
5,105,949	4/1992	Blair	206/528 X
5,239,491	8/1993	Mucciacciaro	368/10 X

[76] Inventors: **Laurence A. Weller; Helen L. Weller**, both of 2101 Santa Clara Dr., Las Vegas, Nev. 89104

Primary Examiner—Prabhakar G. Deshmukh

[**] Term: **14 Years**

[57] CLAIM

[21] Appl. No.: **53,130**

The ornamental design for a painted glass pill container with attachable mounting plate, as shown and described.

[22] Filed: **Apr. 15, 1996**

DESCRIPTION

[52] U.S. Cl. **D3/203**

[58] Field of Search D3/203, 201, 273; D9/428, 414, 337, 341; D24/232; 206/528, 530, 828, 385, 407; 220/694, 729; 368/10

FIG. 1 is a front elevational view of the painted glass pill container with attachable mounting plate showing our new design;

FIG. 2 is a rear elevational view thereof;

FIG. 3 is a left side elevational view thereof;

FIG. 4 is a right side elevational view thereof;

FIG. 5 is a top plan view thereof;

FIG. 6 is a bottom plan view thereof; and,

FIG. 7 is a perspective view of thereof; the broken line showing of a conventional wristwatch is for illustrative purpose and forms no part of the claim.

[56] References Cited

U.S. PATENT DOCUMENTS

D. 305,614	1/1990	Gotlib	D9/337
D. 311,774	10/1990	Lax	D3/203 X
3,726,447	4/1973	Klygis	220/694 X
4,382,688	5/1983	Machamer	368/10
4,630,933	12/1986	Horii	368/10

1 Claim, 3 Drawing Sheets

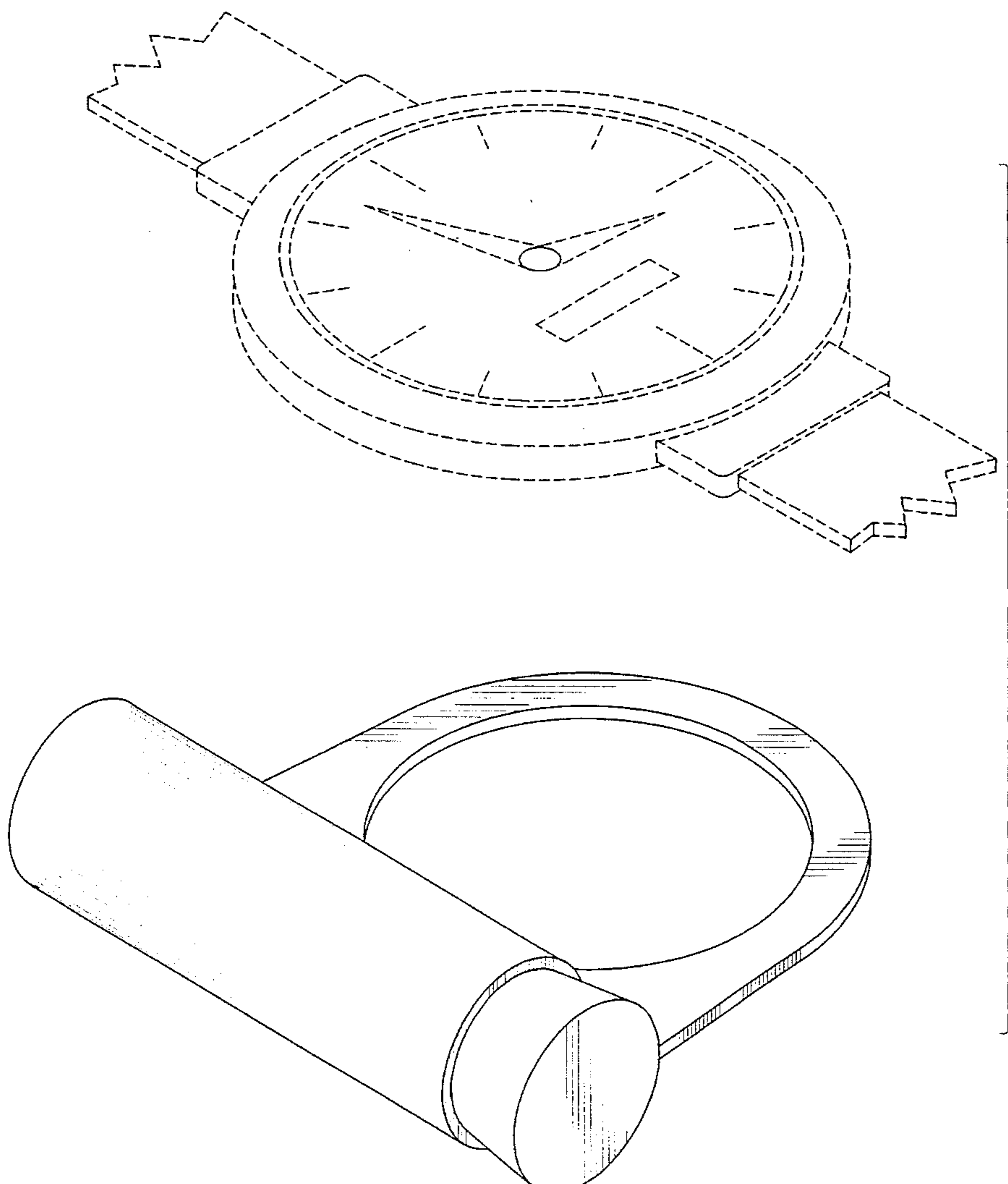

FIG. 1

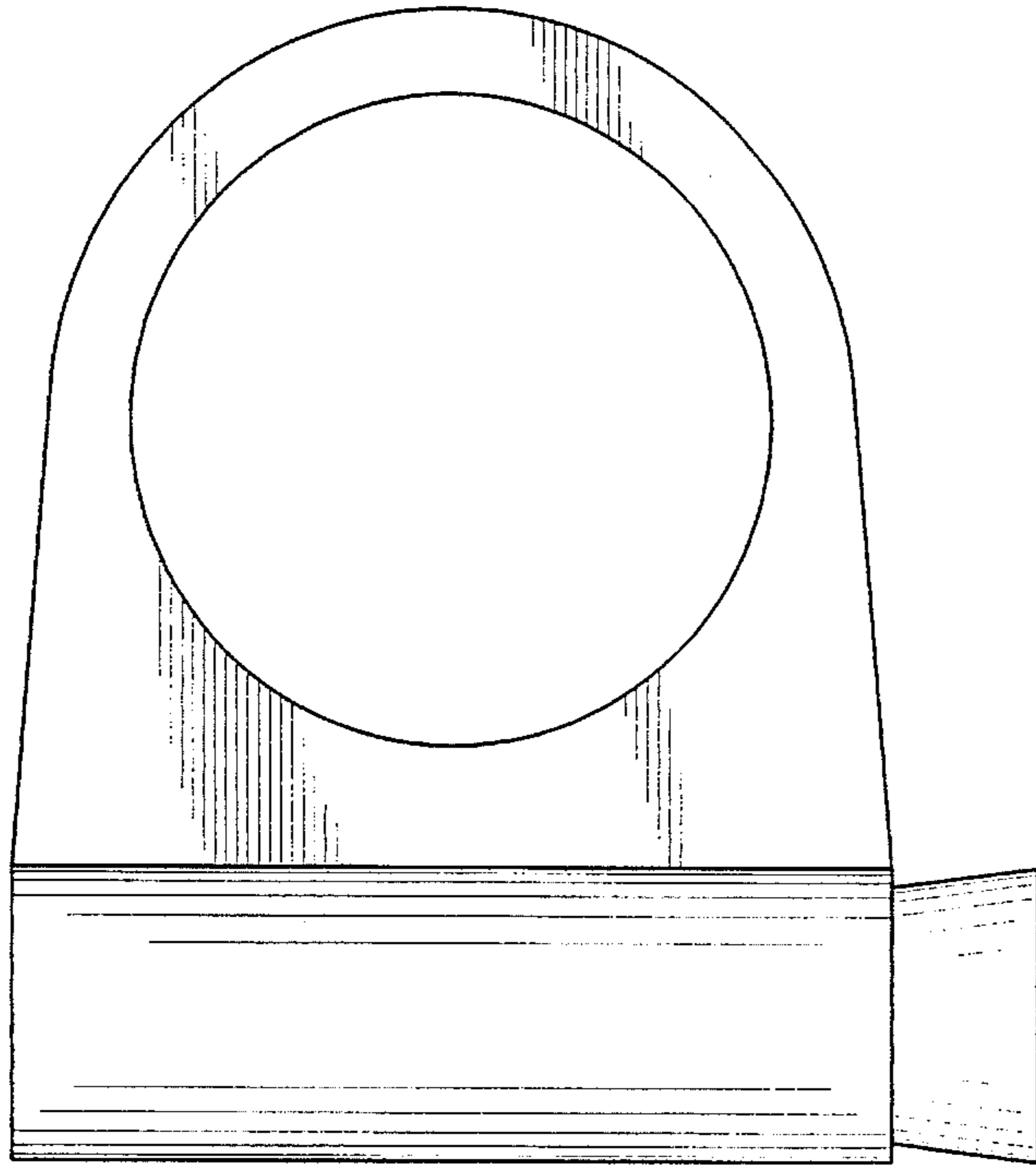

FIG. 2

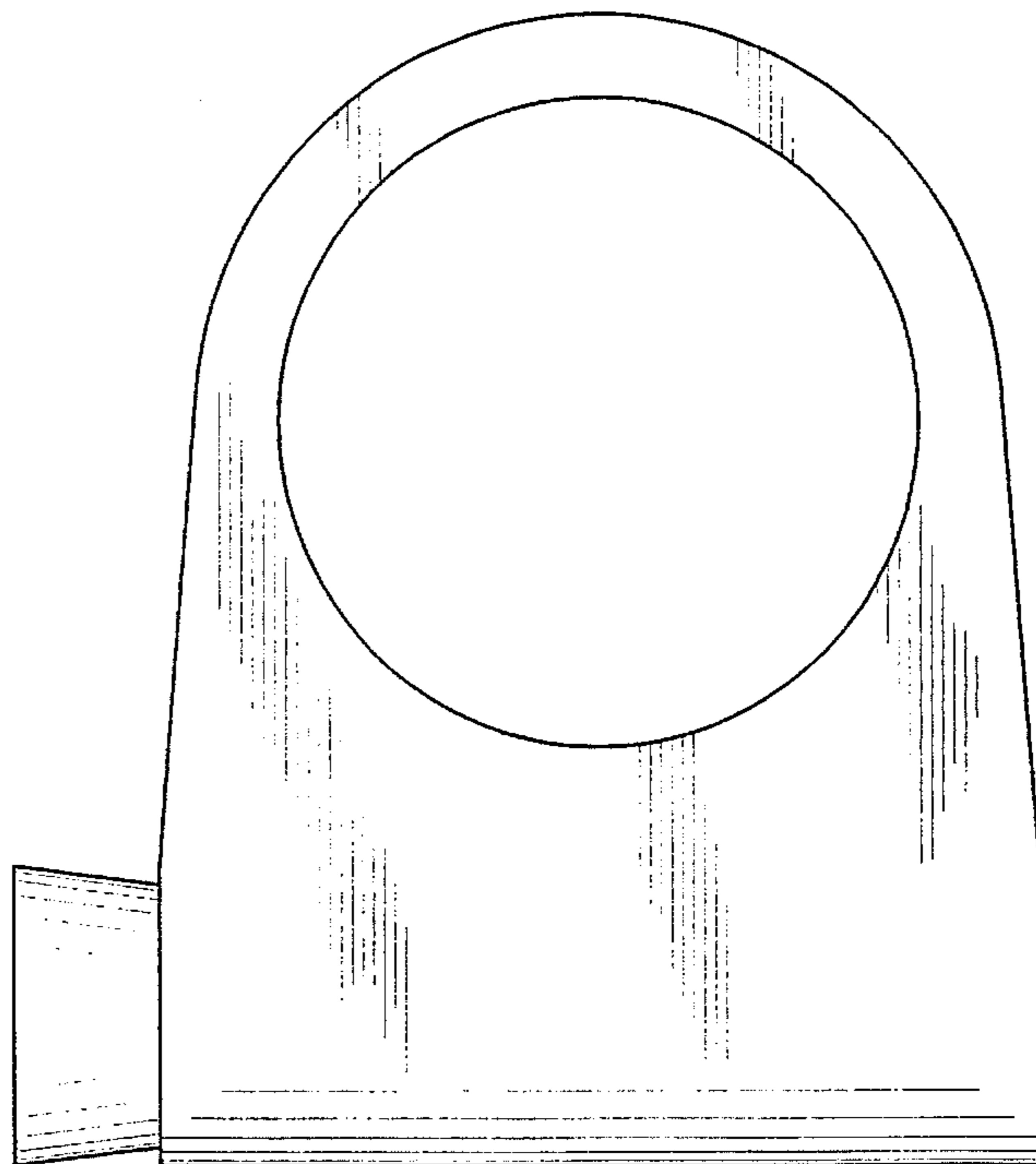

FIG. 3

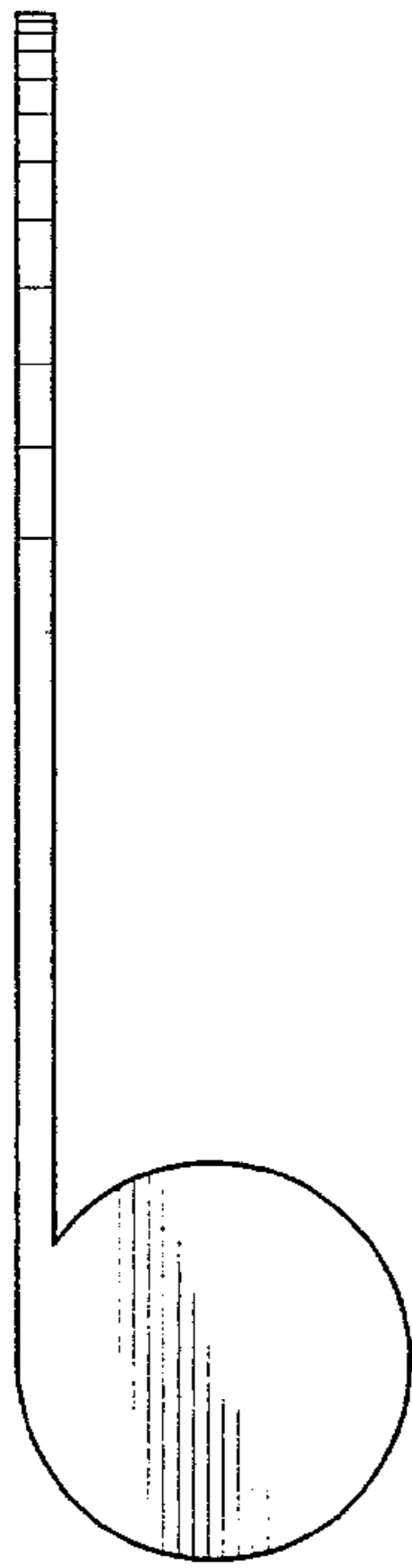

FIG. 4

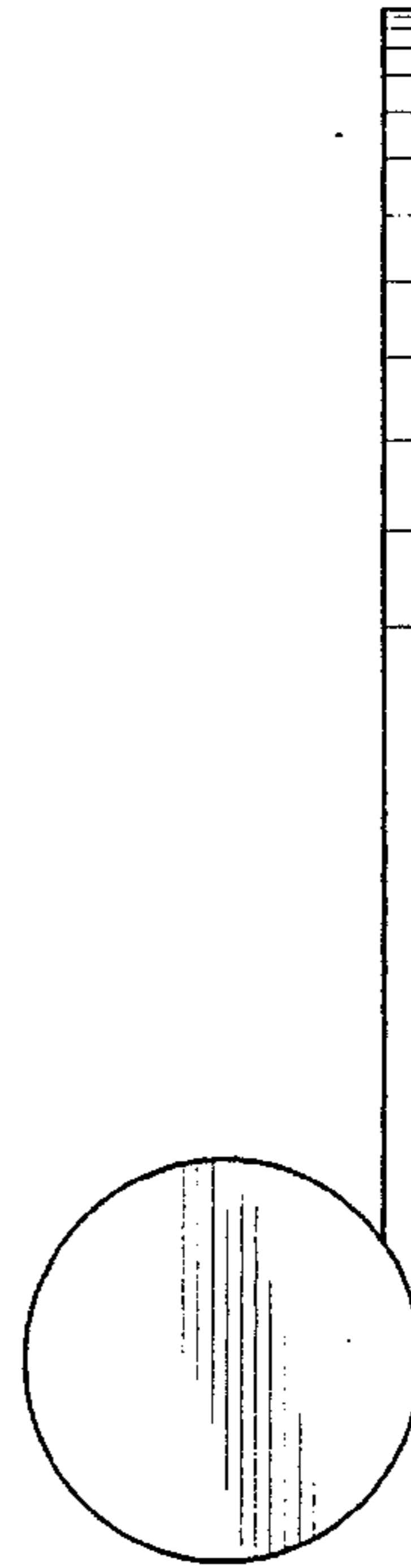

FIG. 5

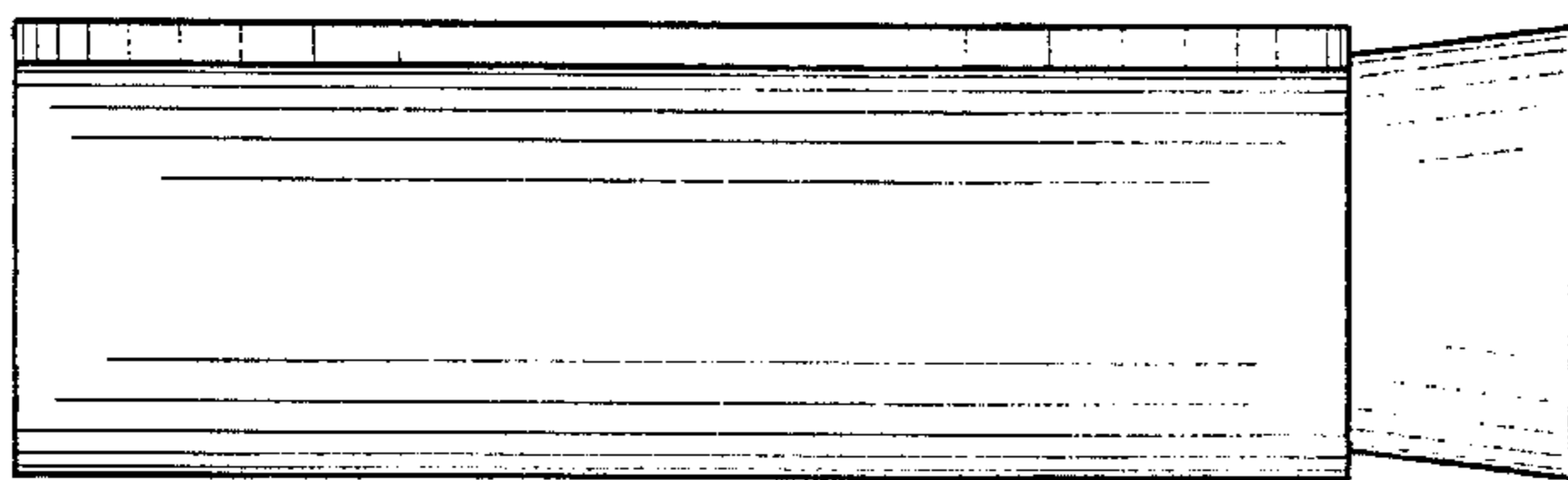

FIG. 6

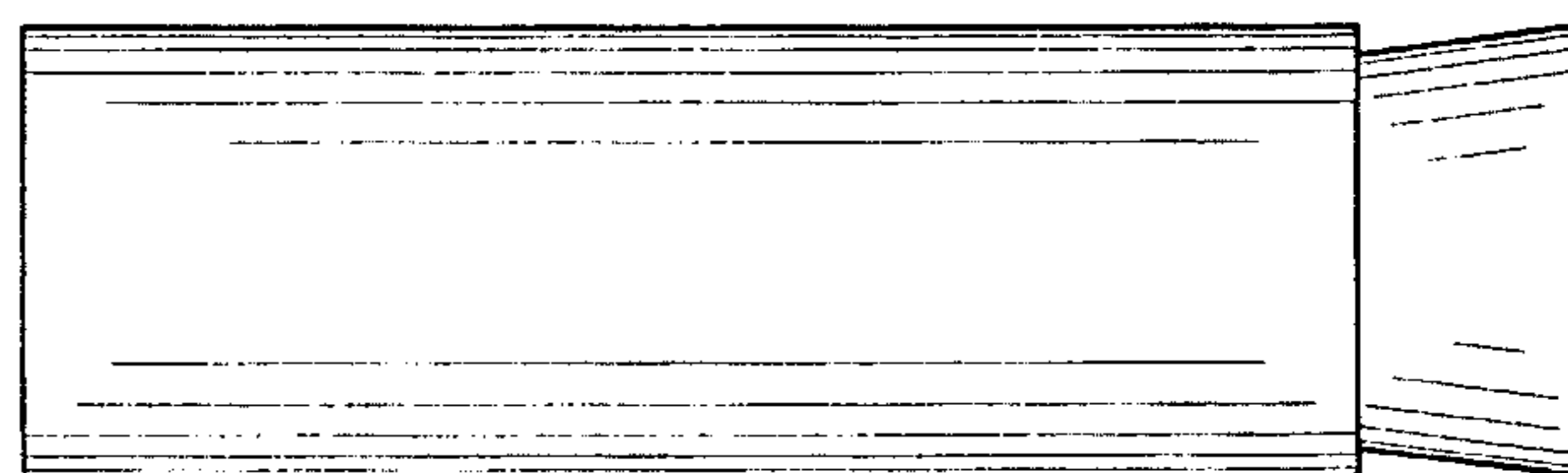

FIG. 7

