



US00D376657S

United States Patent [19]

[11] Patent Number: **Des. 376,657**

Bohn

[45] Date of Patent: ****Dec. 17, 1996**

[54] **LIGHTED BLOCK**

Primary Examiner—Raphael Barkai
Attorney, Agent, or Firm—Dorsey & Whitney LLP

[75] Inventor: **Kenneth C. Bohn**, Cambridge, Minn.

[57] **CLAIM**

[73] Assignee: **Core Masters, Inc.**, Cambridge, Minn.

The ornamental design for a lighted block, as shown and described.

[**] Term: **14 Years**

DESCRIPTION

[21] Appl. No.: **50,859**

FIG. 1 is a perspective view of the design;
FIG. 2 is a front elevational view thereof;
FIG. 3 is a rear elevational view thereof;
FIG. 4 is a top plan view thereof;
FIG. 5 is a bottom plan view thereof;
FIG. 6 is a side elevational view thereof with the other side being a mirror image;
FIG. 7 is a perspective view of a modified embodiment of the design shown in FIGS. 1-6;
FIG. 8 is a front elevational view thereof;
FIG. 9 is a rear elevational view thereof;
FIG. 10 is a top plan view thereof;
FIG. 11 is a bottom plan view thereof; and,
FIG. 12 is a side elevational view thereof with the opposite side being a mirror image.
The broken lines shown in FIG. 1 and 7 are for illustrative purposes only and form no part of the claimed design.

[22] Filed: **Feb. 28, 1996**

[52] U.S. Cl. **D25/113**; D26/51; D26/67

[58] **Field of Search** D25/113-118;
D21/108; D26/51, 67; 52/592.5, 592.6,
604, 606, 608, 390-392, DIG. 9; 404/42;
362/145, 146, 153, 153.1; 446/110, 117,
120, 124, 125

[56] References Cited

U.S. PATENT DOCUMENTS

D. 352,789	11/1994	Adam	D25/113
4,907,361	3/1990	Villard	362/153.1
5,065,291	11/1991	Frost et al.	362/145
5,160,202	11/1992	Legare	362/153.1
5,294,216	3/1994	Sievert	52/604
5,353,569	10/1994	Rodrique	52/604
5,390,090	2/1995	Nau	362/153.1

1 Claim, 4 Drawing Sheets

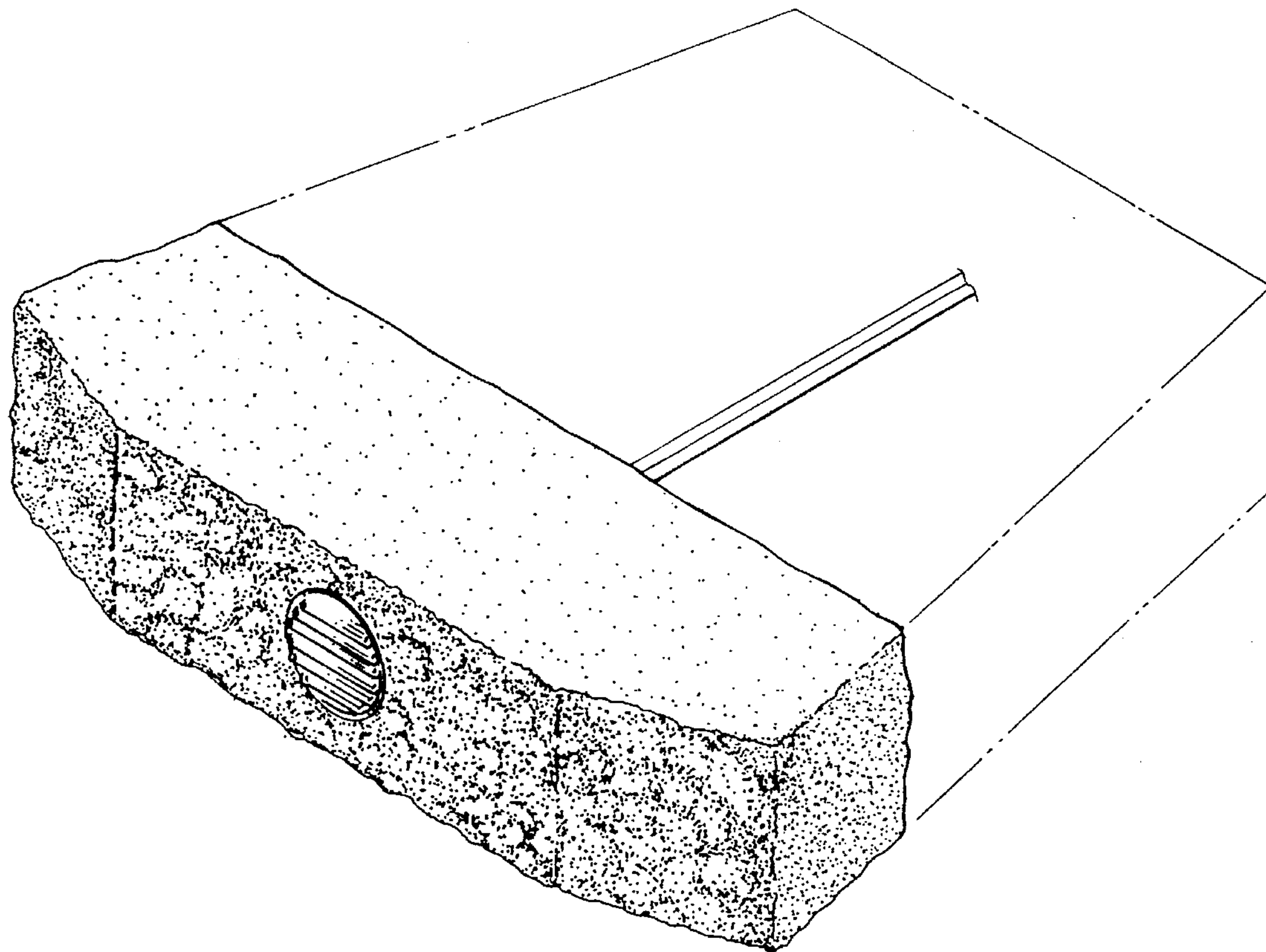

Fig. 1

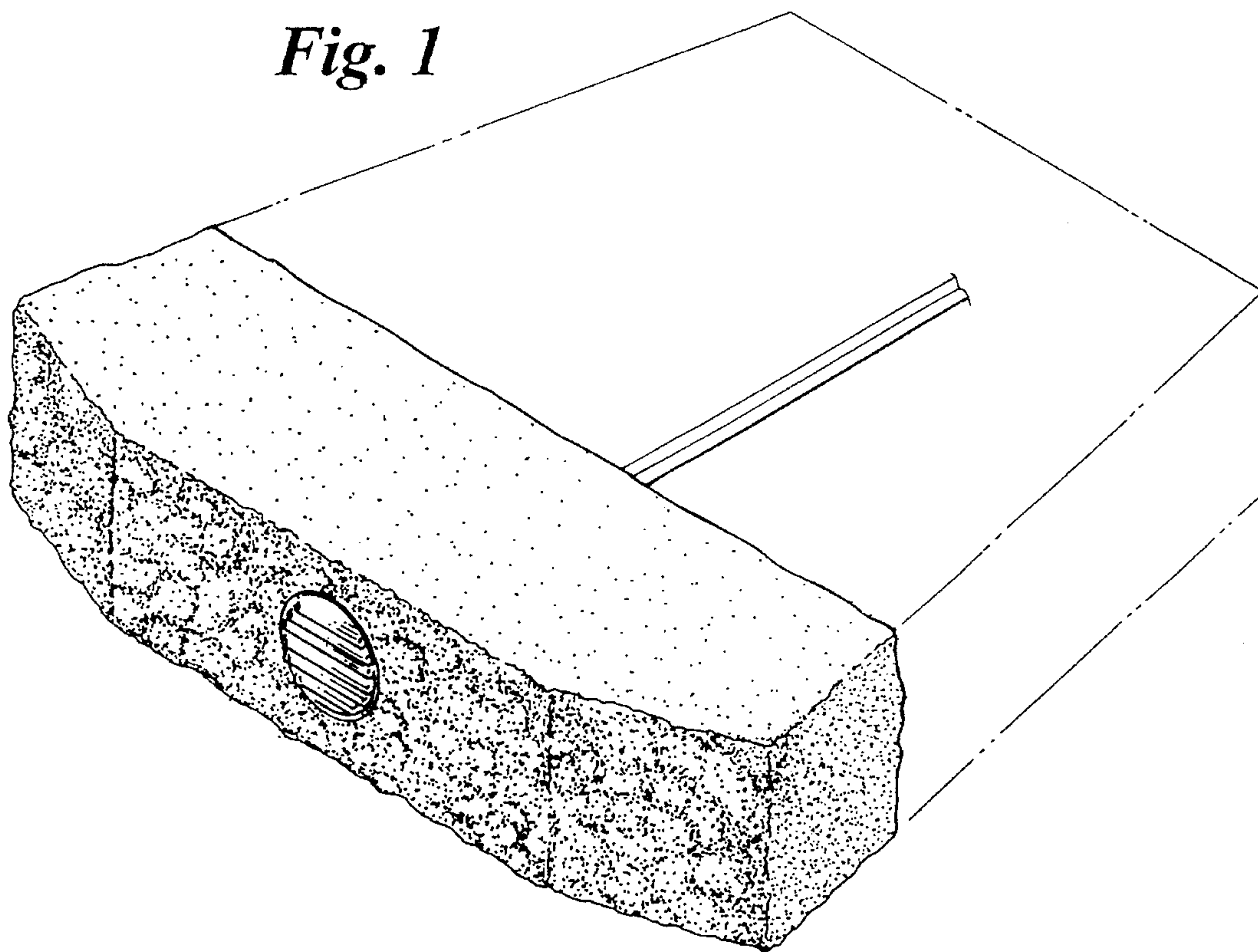

Fig. 2

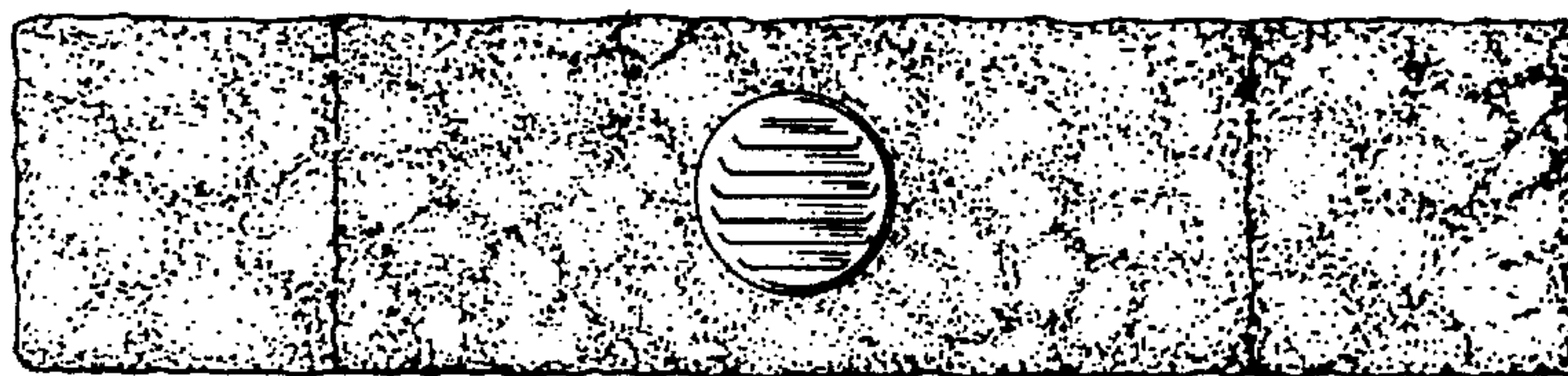

Fig. 3

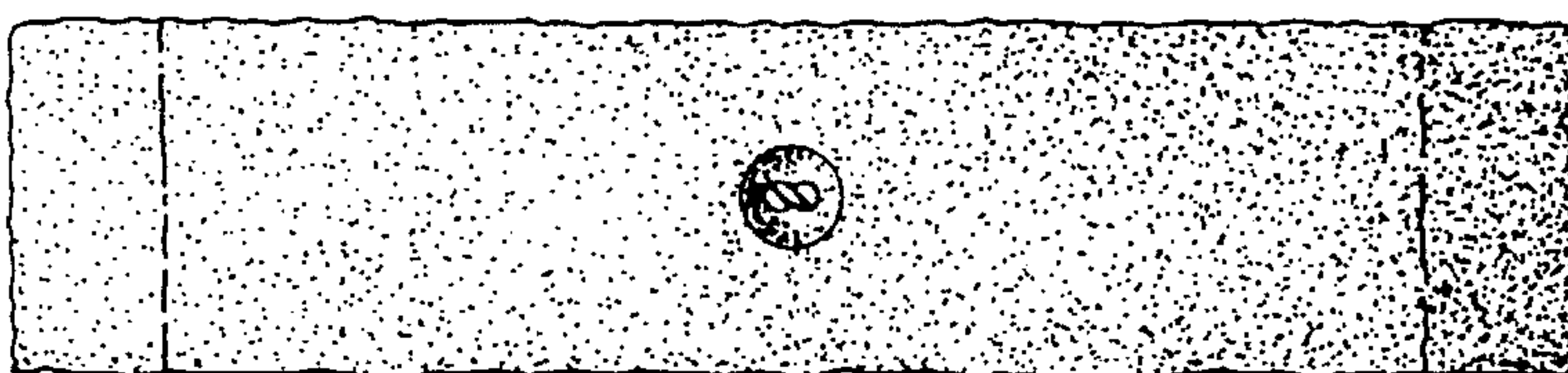

Fig. 4

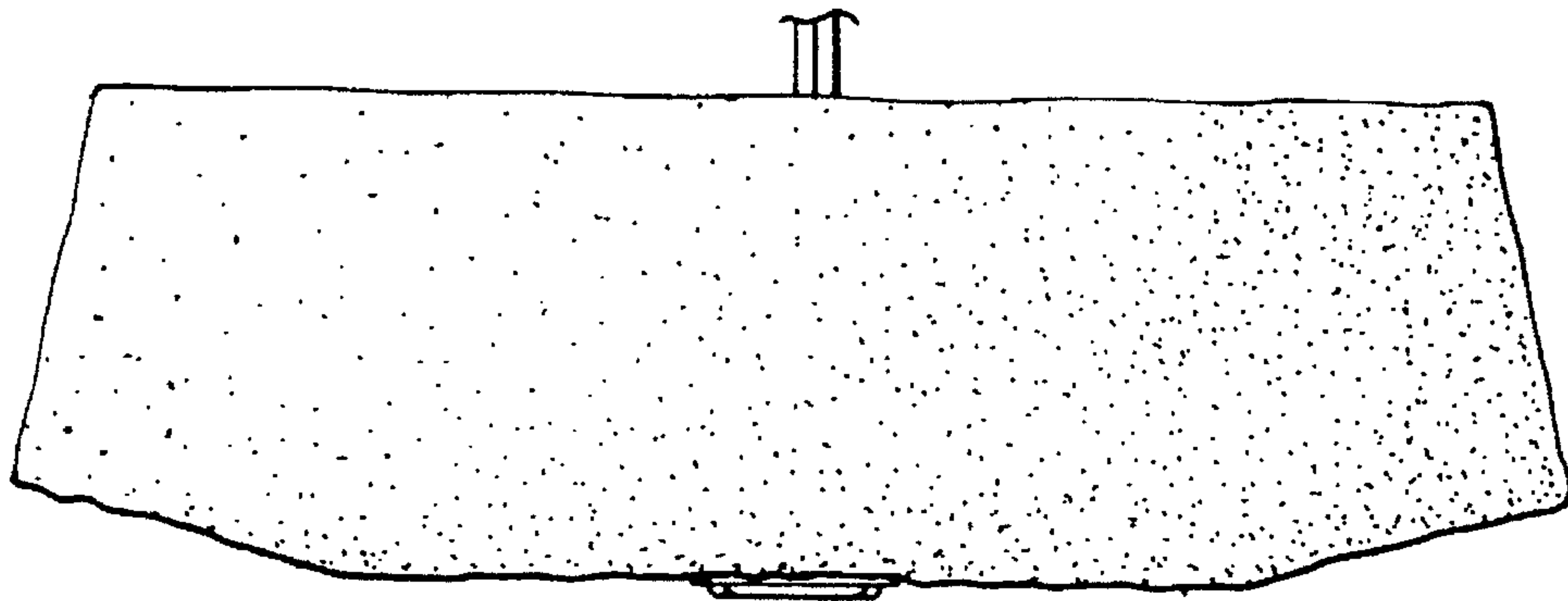

Fig. 5

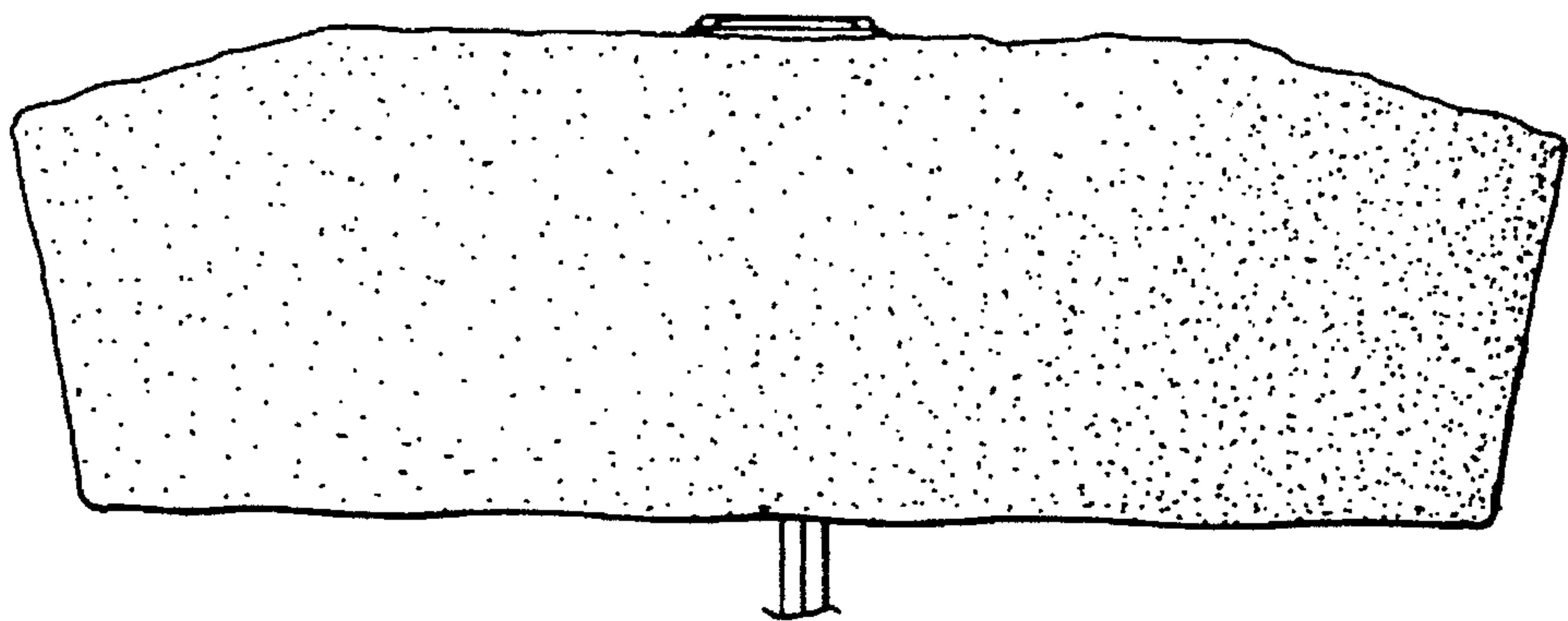

Fig. 6

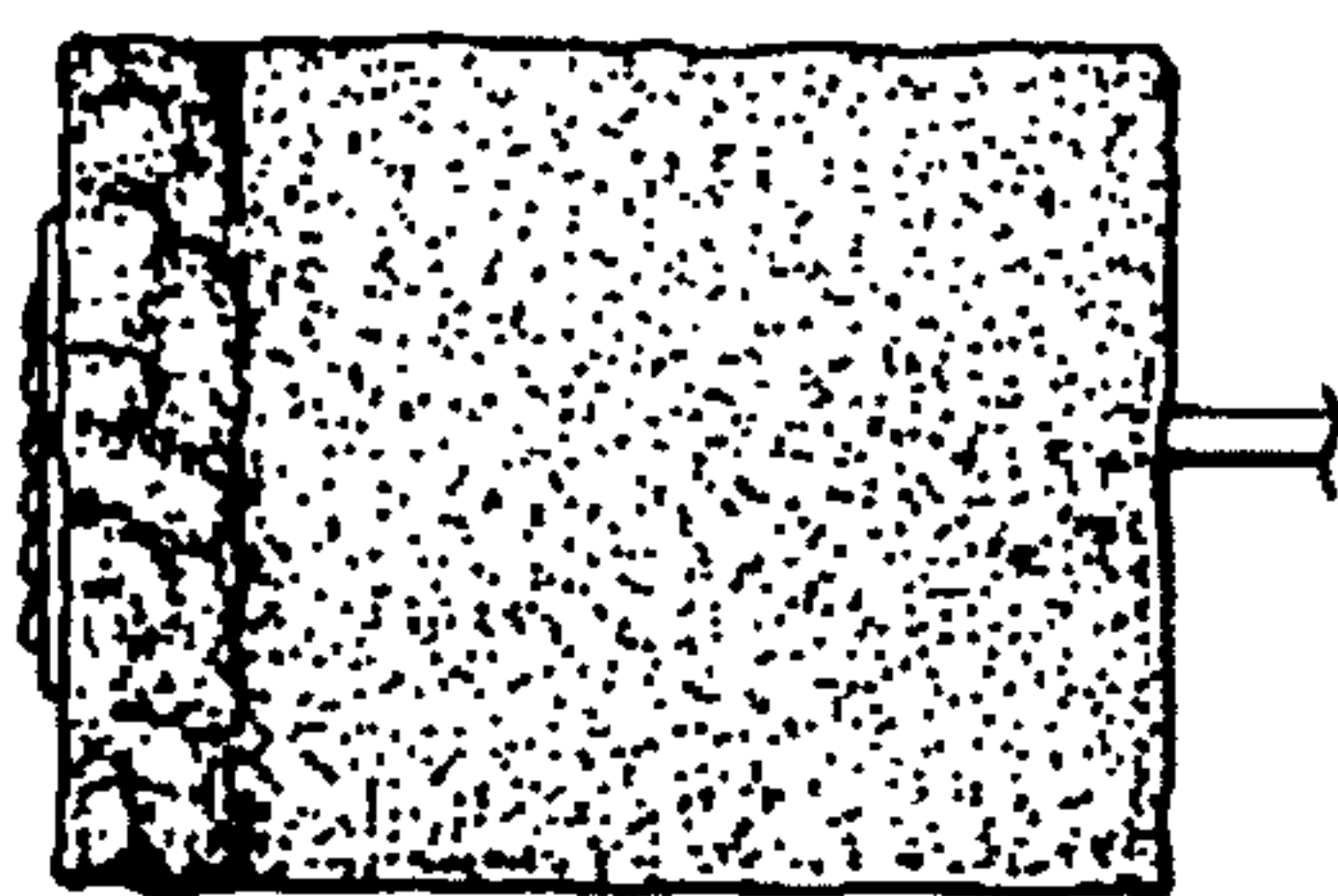

Fig. 7

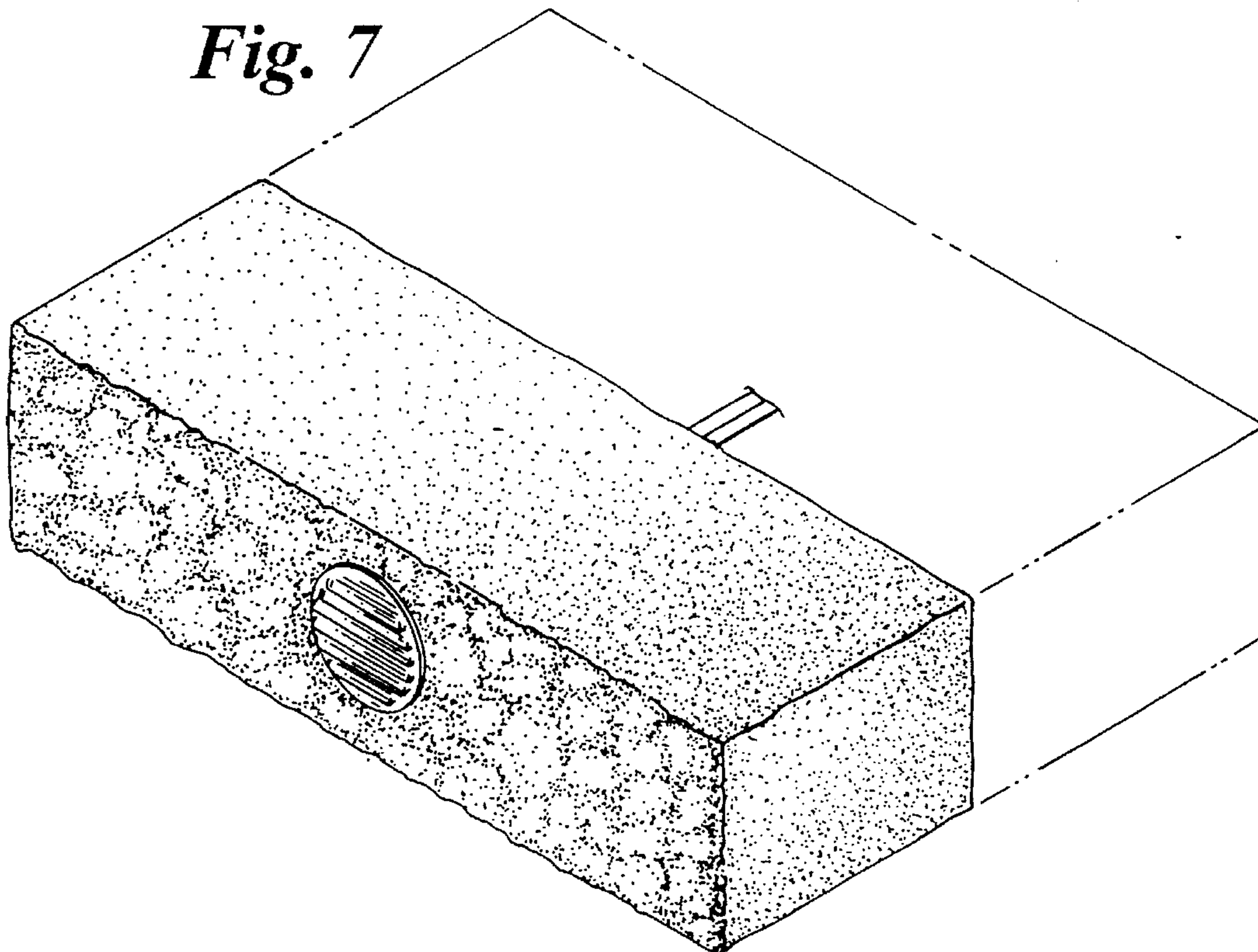

Fig. 8

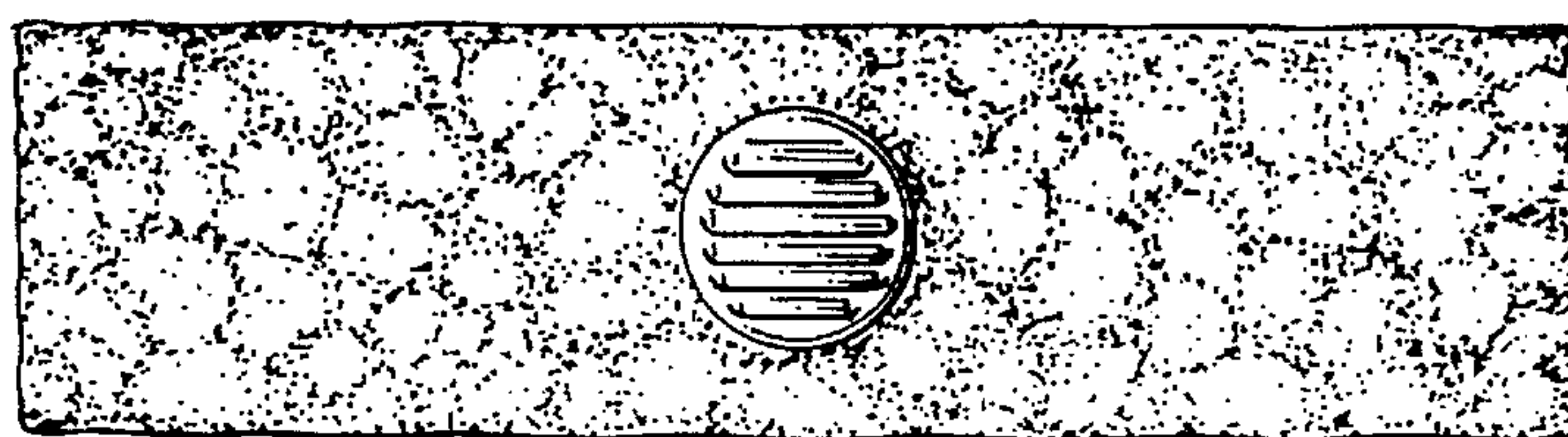

Fig. 9

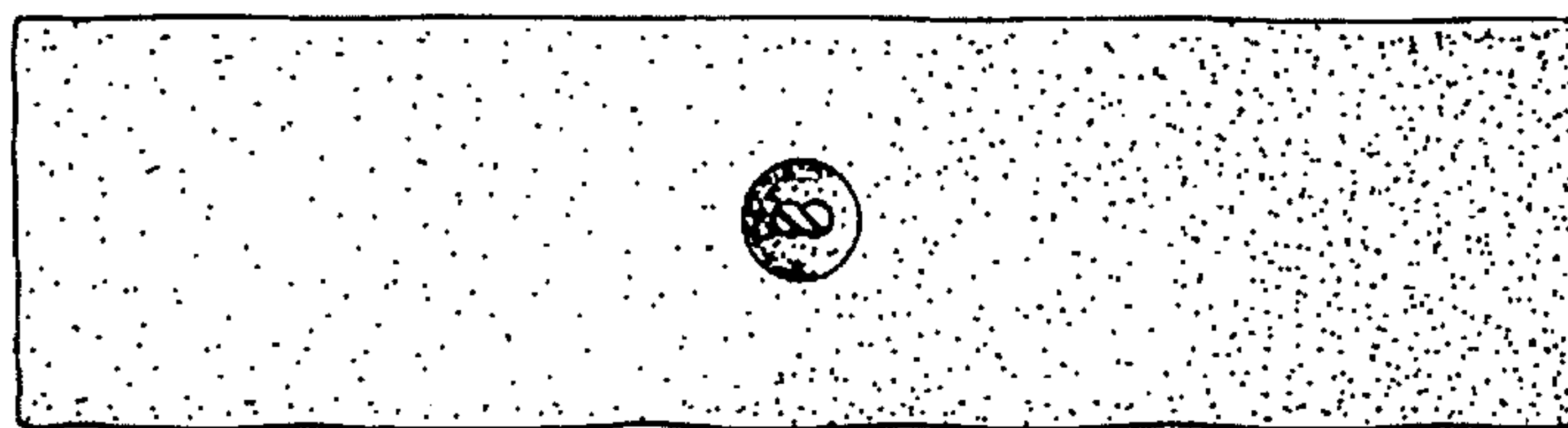

Fig. 10

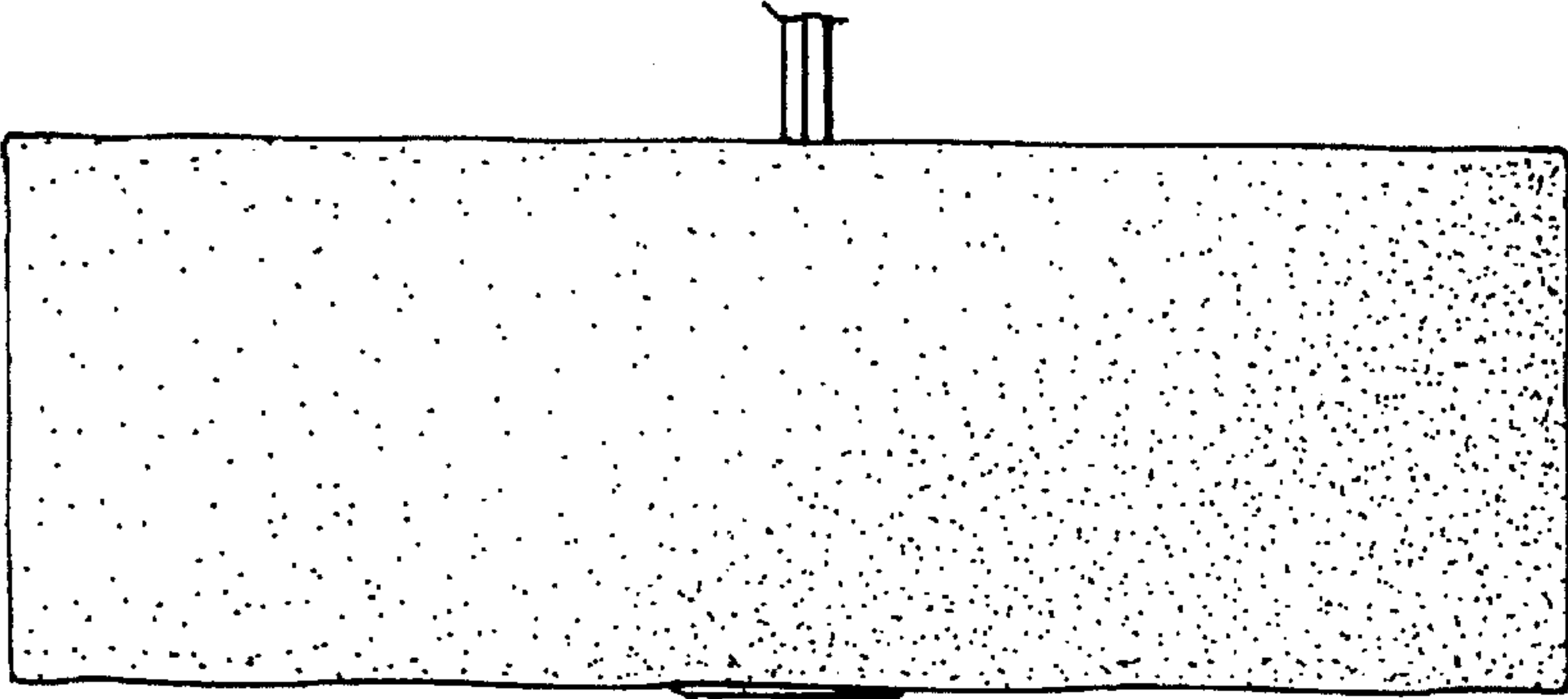

Fig. 11

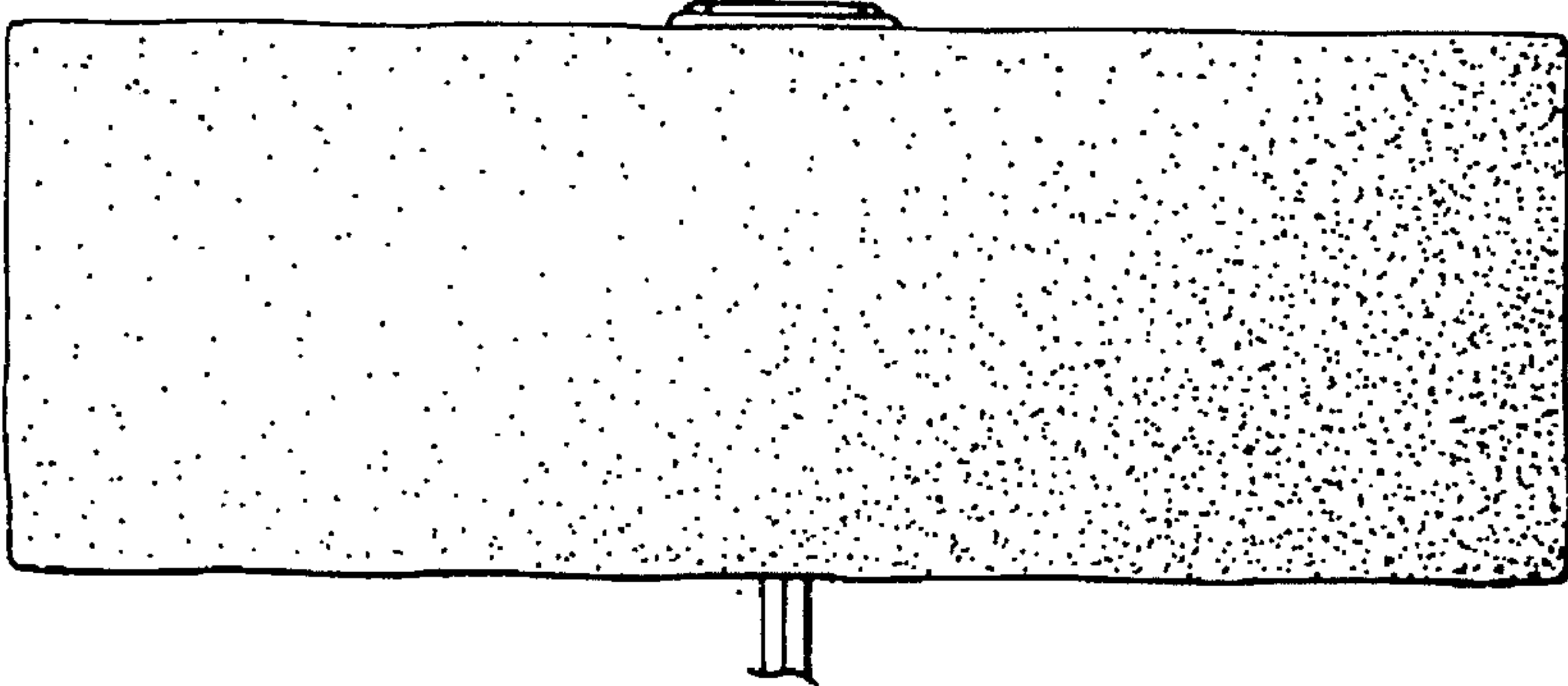

Fig. 12

