



US00D376654S

United States Patent [19]

[11] **Patent Number: Des. 376,654**

McLaughlin

[45] **Date of Patent: **Dec. 17, 1996**

[54] **MANHOLE COVER PICK HOLE PLUG**

[75] Inventor: **Scott D. McLaughlin**, Mead, Wash.

[73] Assignee: **Olympic Foundry Inc.**, Seattle, Wash.

[**] Term: **14 Years**

[21] Appl. No.: **34,862**

[22] Filed: **Feb. 8, 1995**

[52] U.S. Cl. **D25/36**

[58] Field of Search **D25/36, 199, 135; 404/25, 26**

[56] **References Cited**

U.S. PATENT DOCUMENTS

D. 219,647	1/1971	Handley et al.	D25/36
4,828,274	5/1989	Stannard	404/25
5,324,135	6/1994	Smith	404/25

Primary Examiner—Doris Clark

Attorney, Agent, or Firm—Wells, St. John, Roberts, Gregory & Matkin P.S.

[57] **CLAIM**

The ornamental design for a manhole cover pick hole plug, as shown and described.

DESCRIPTION

FIG. 1 is a perspective view of a manhole cover pick hole plug showing my new design;

FIG. 2 is a front elevation view thereof, the opposite back being a mirror image thereof;

FIG. 3 is a right side elevation view thereof, the opposite left side being a mirror image thereof;

FIG. 4 is a top plan view thereof;

FIG. 5 is a bottom plan view thereof;

FIG. 6 is a perspective view of a second embodiment of the manhole cover pick hole plug shown in FIG. 1;

FIG. 7 is a front elevation view thereof, the opposite back being a mirror image thereof;

FIG. 8 is a right side elevation view thereof, the opposite left side being a mirror image thereof;

FIG. 9 is a bottom plan view thereof, the opposed top being identical to FIG. 4;

FIG. 10 is a perspective view of a third embodiment of the manhole cover pick hole plug shown in FIG. 1;

FIG. 11 is a front elevation view thereof, the opposite back being a mirror image thereof;

FIG. 12 is a right side elevation view thereof, the opposite left side being a mirror image thereof; and,

FIG. 13 is a bottom plan view thereof, the opposed top being identical to FIG. 4.

1 Claim, 3 Drawing Sheets

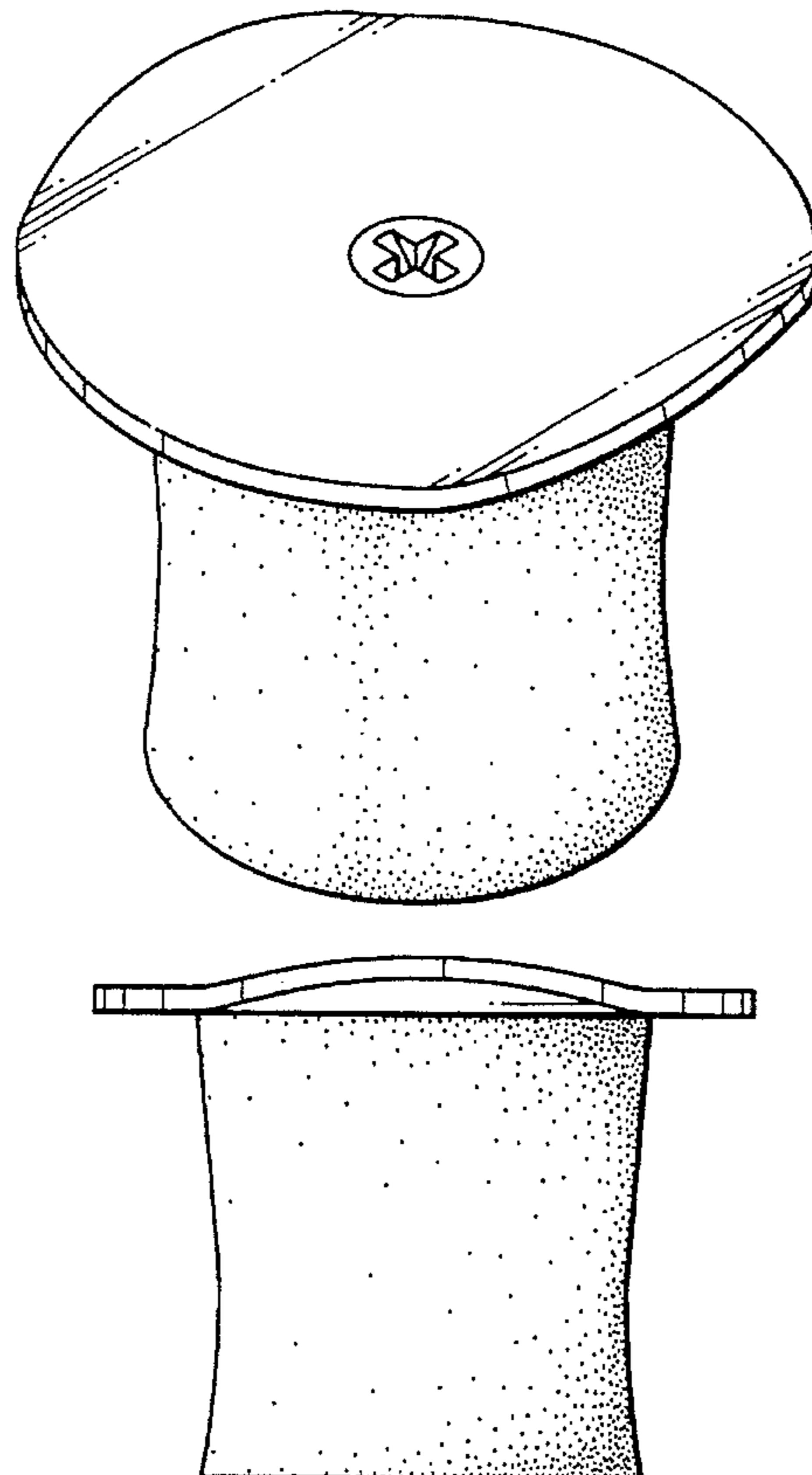

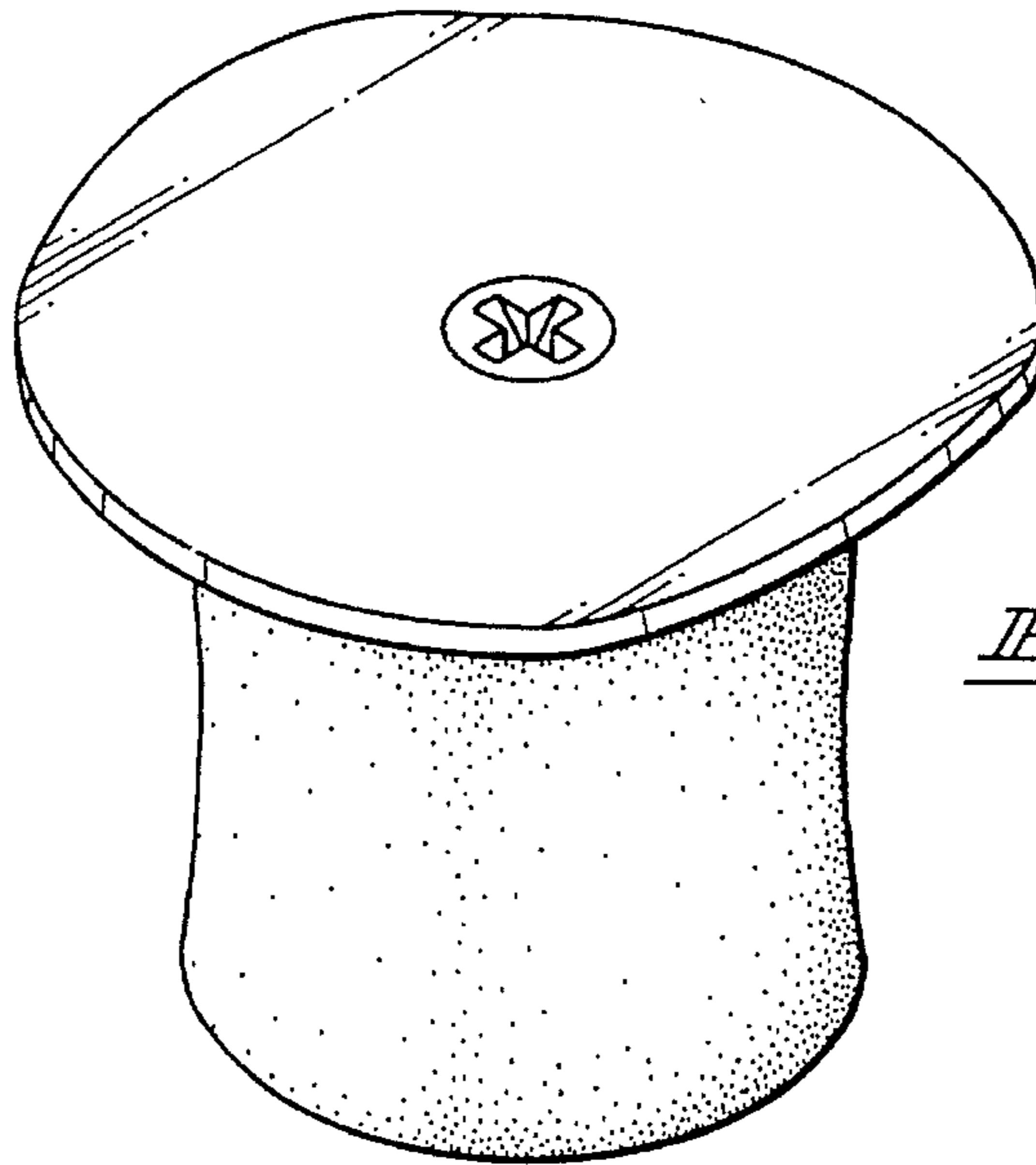

Fig. 1

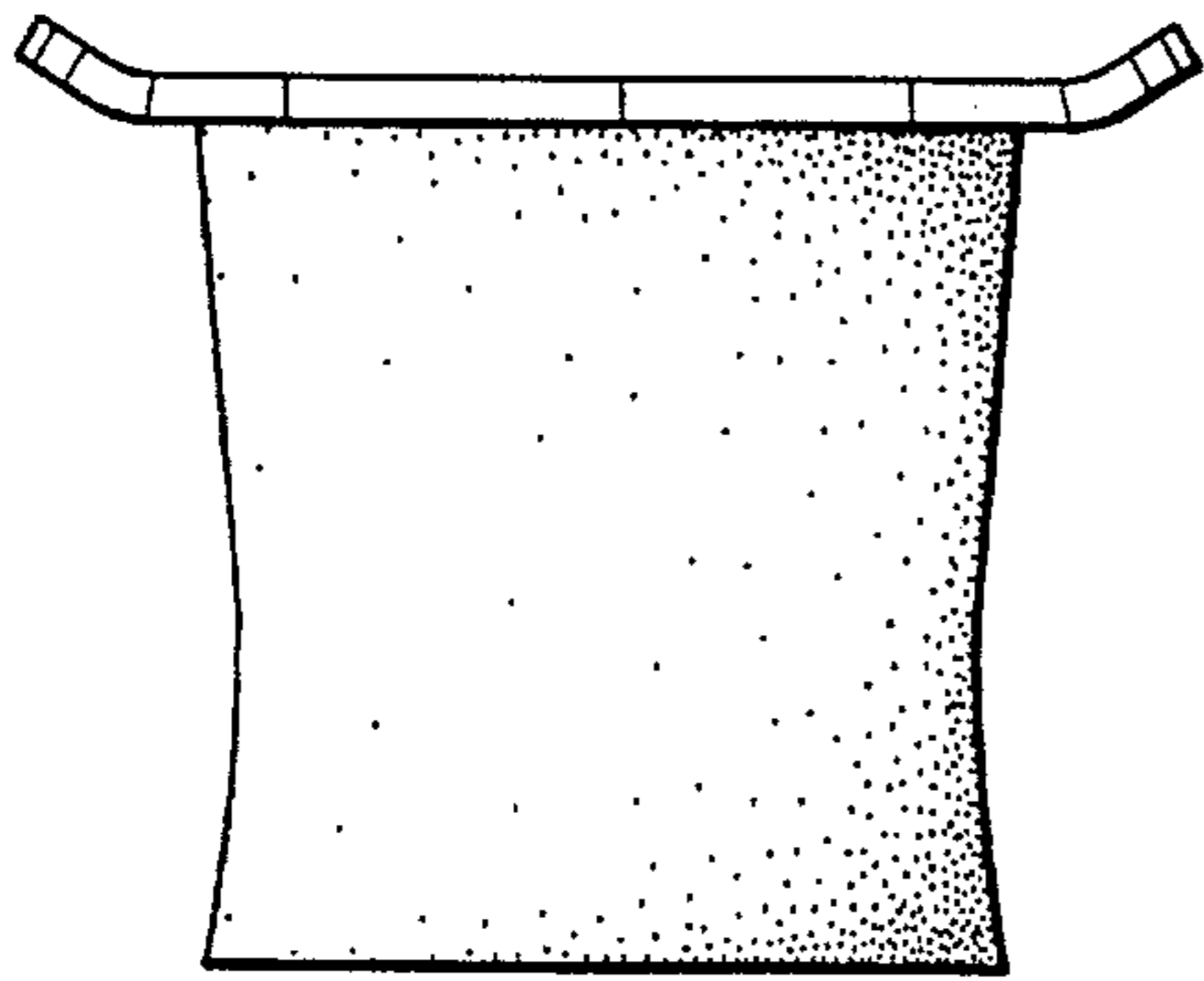

Fig. 2

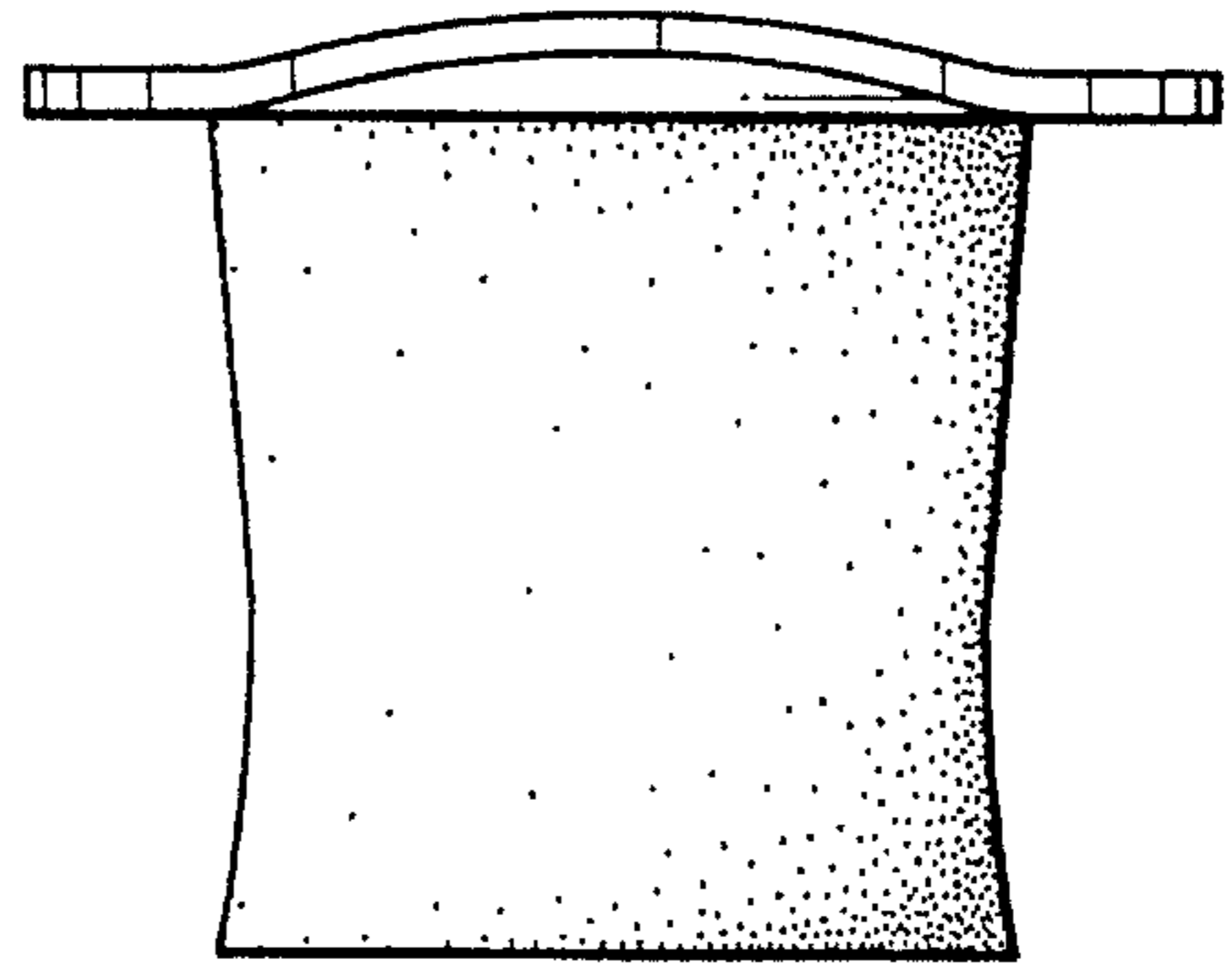

Fig. 3

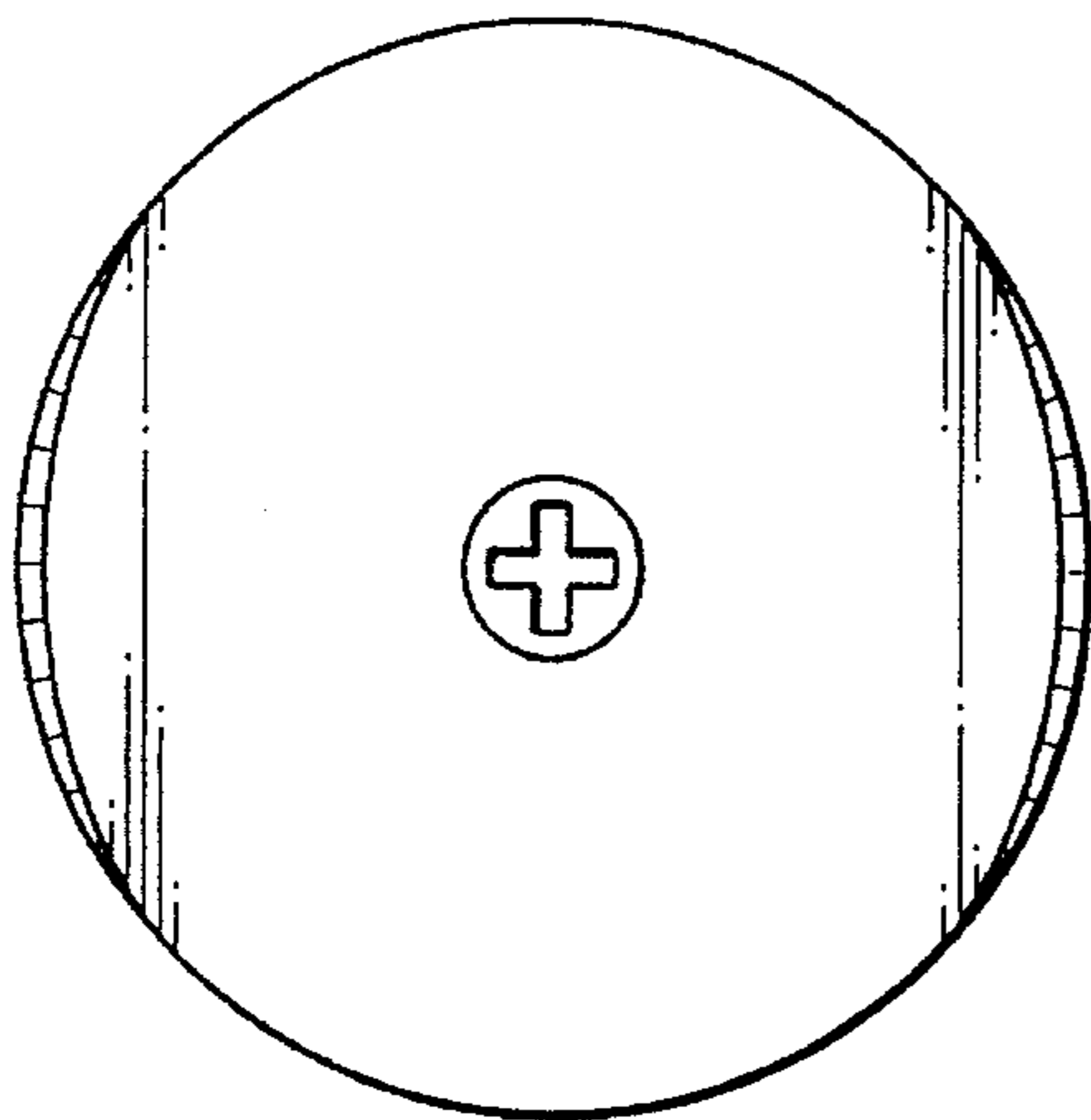

Fig. 4

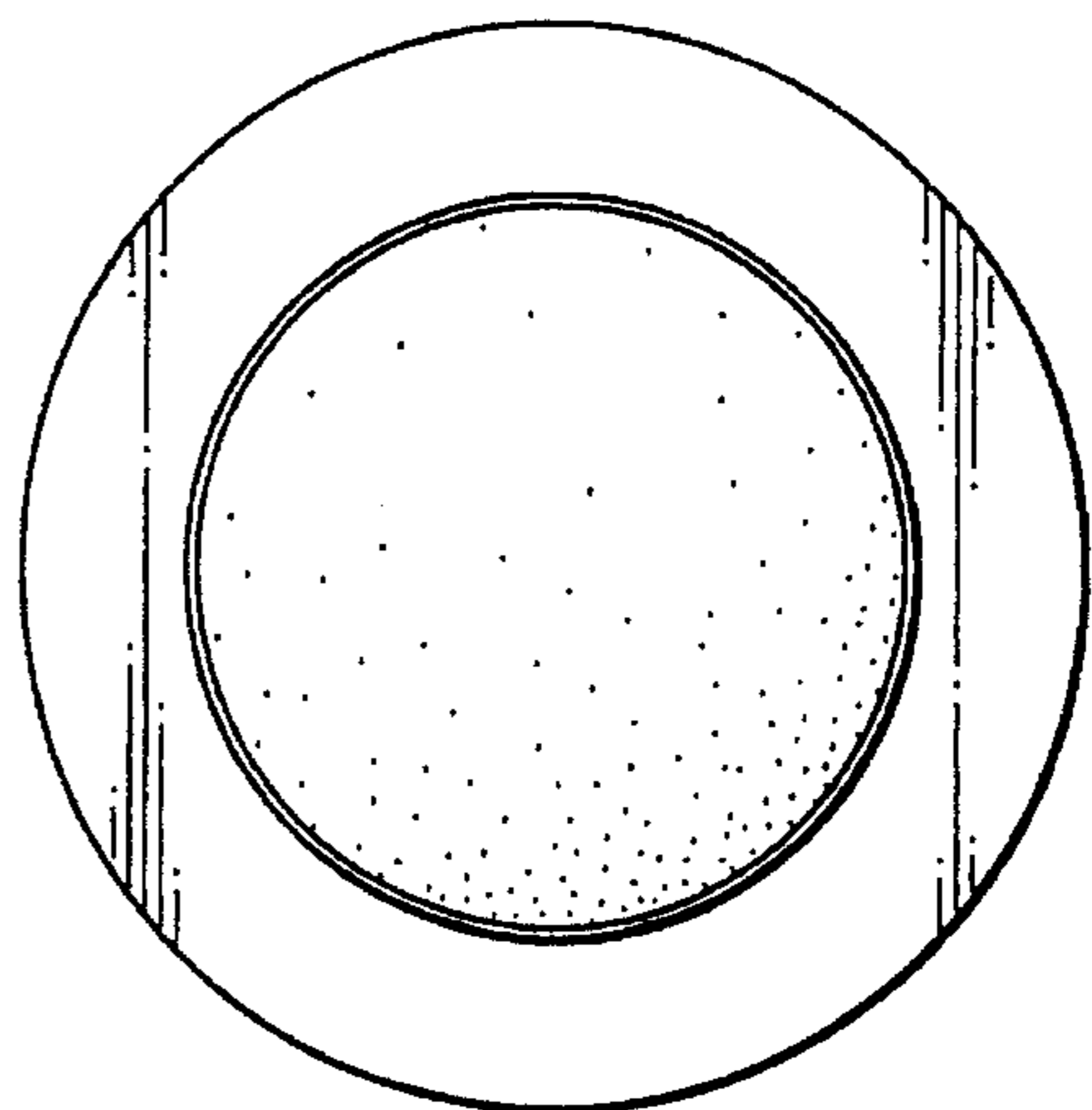

Fig. 5

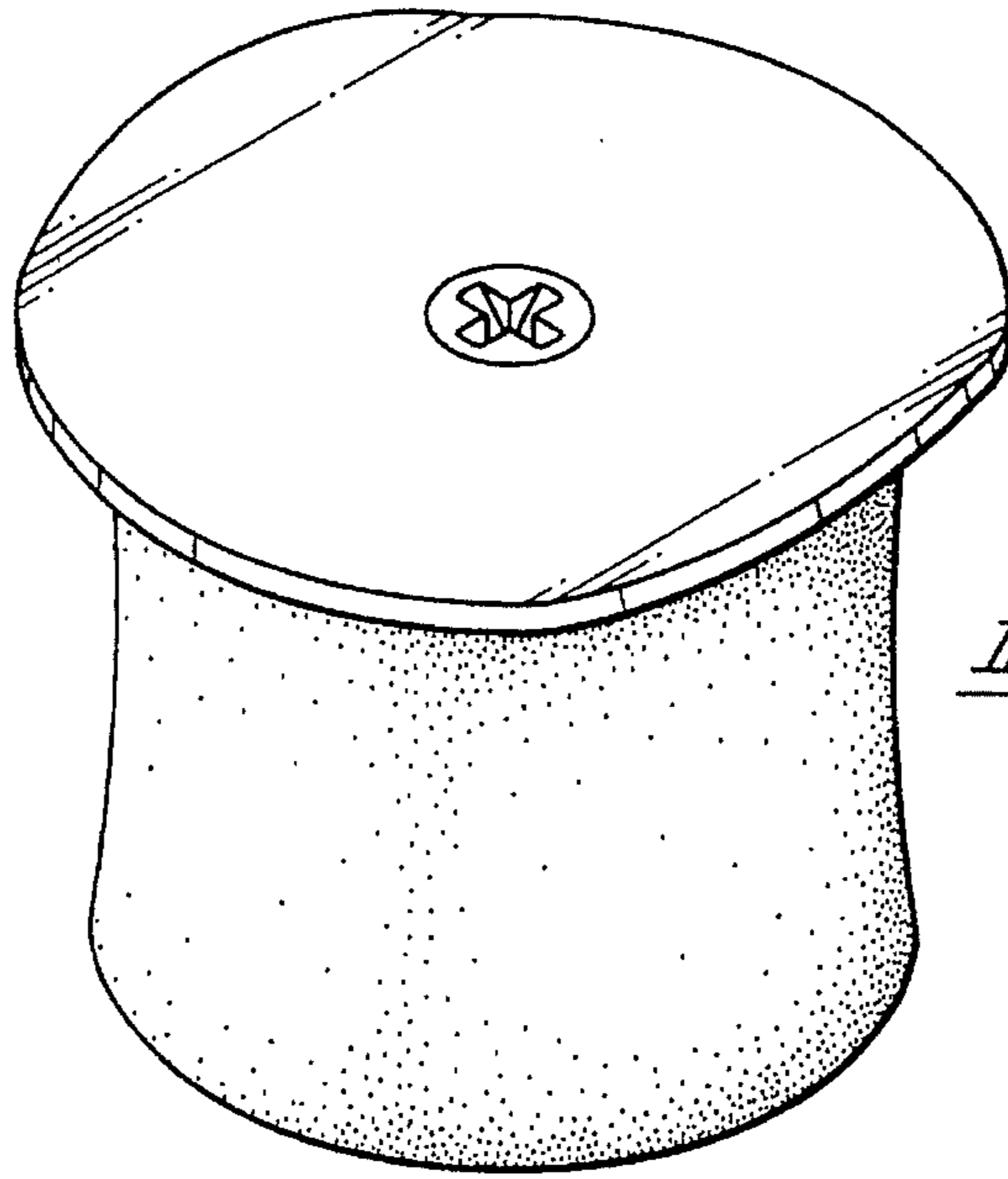

Fig. 6

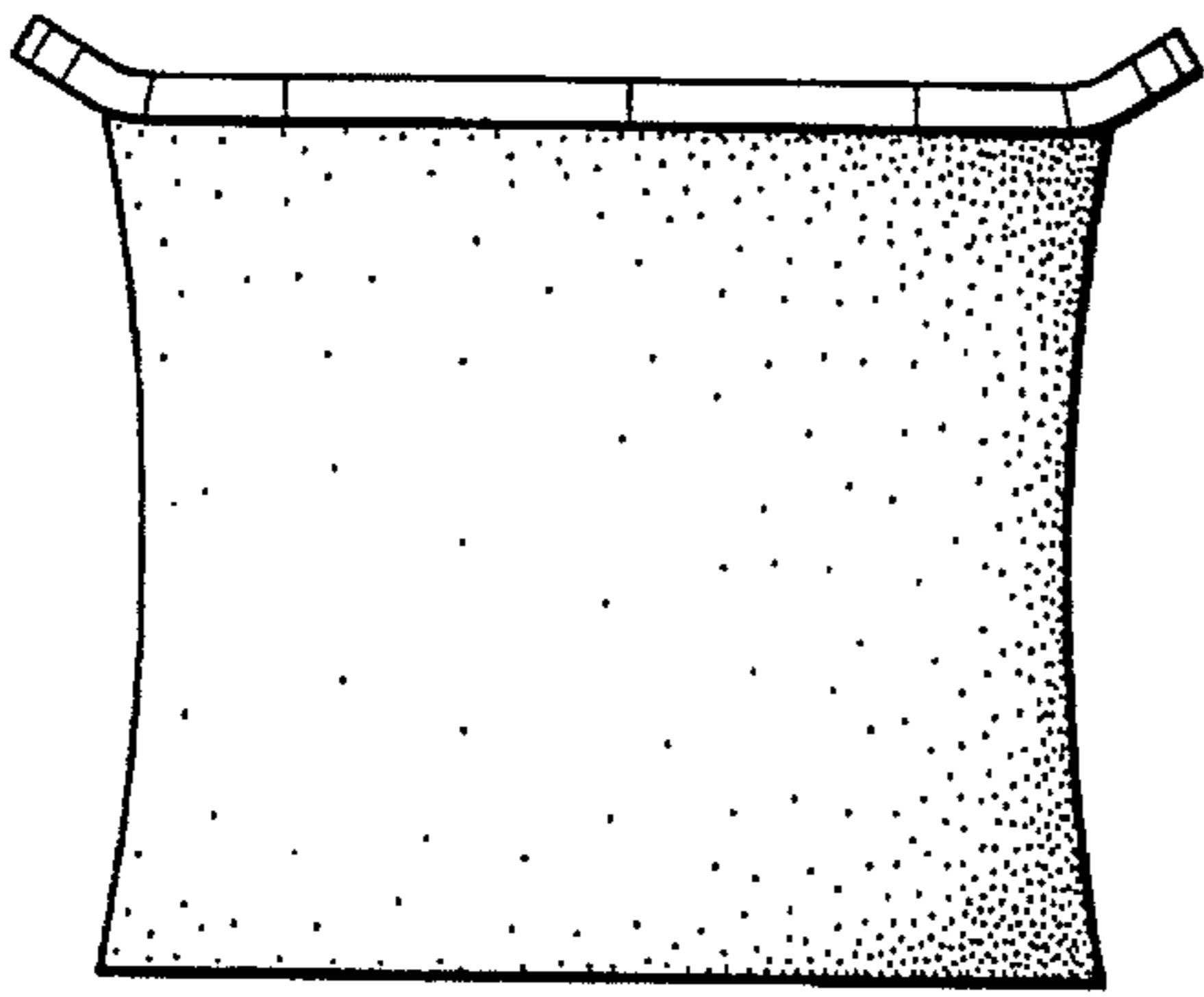

Fig. 7

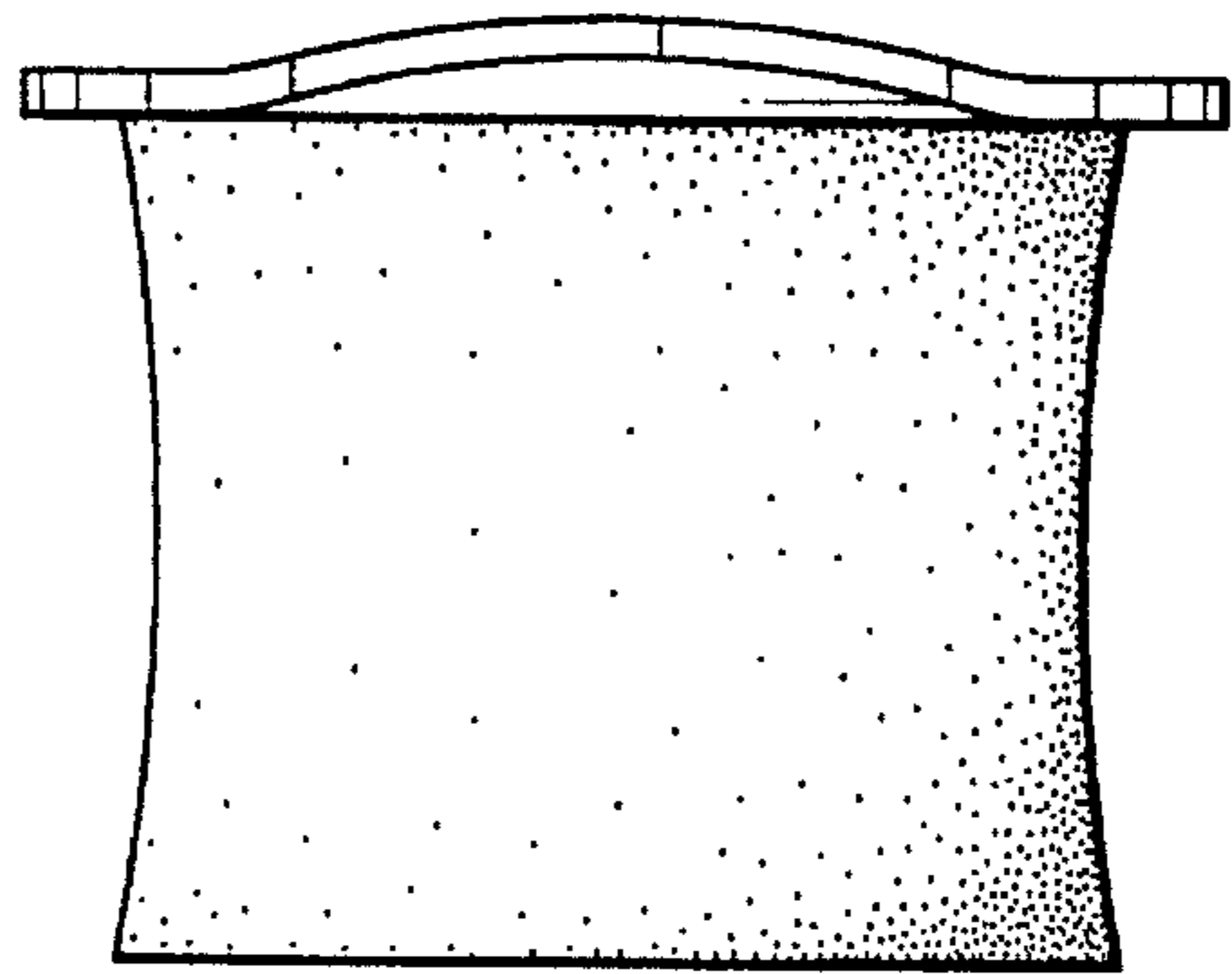

Fig. 8

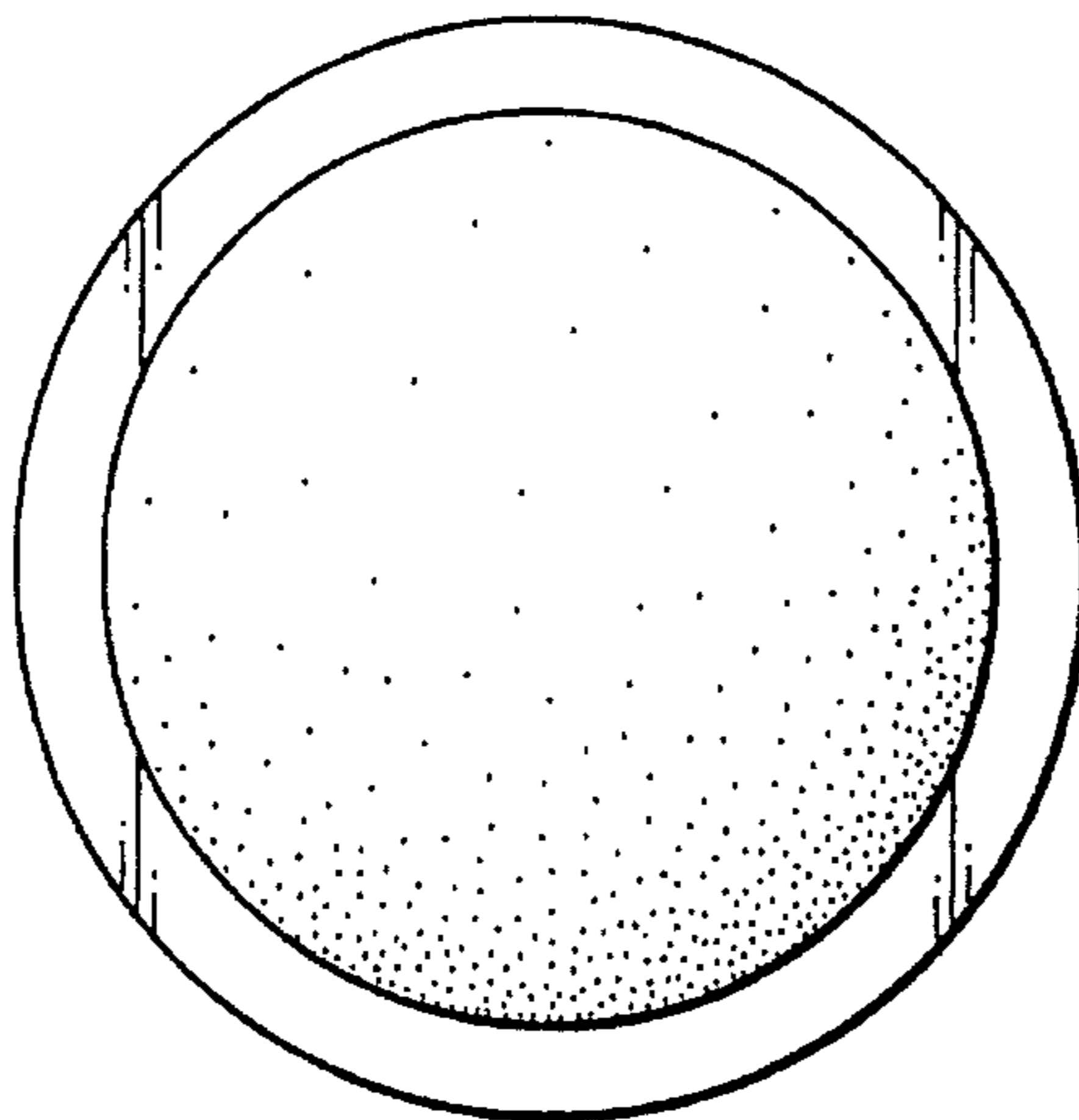

Fig. 9

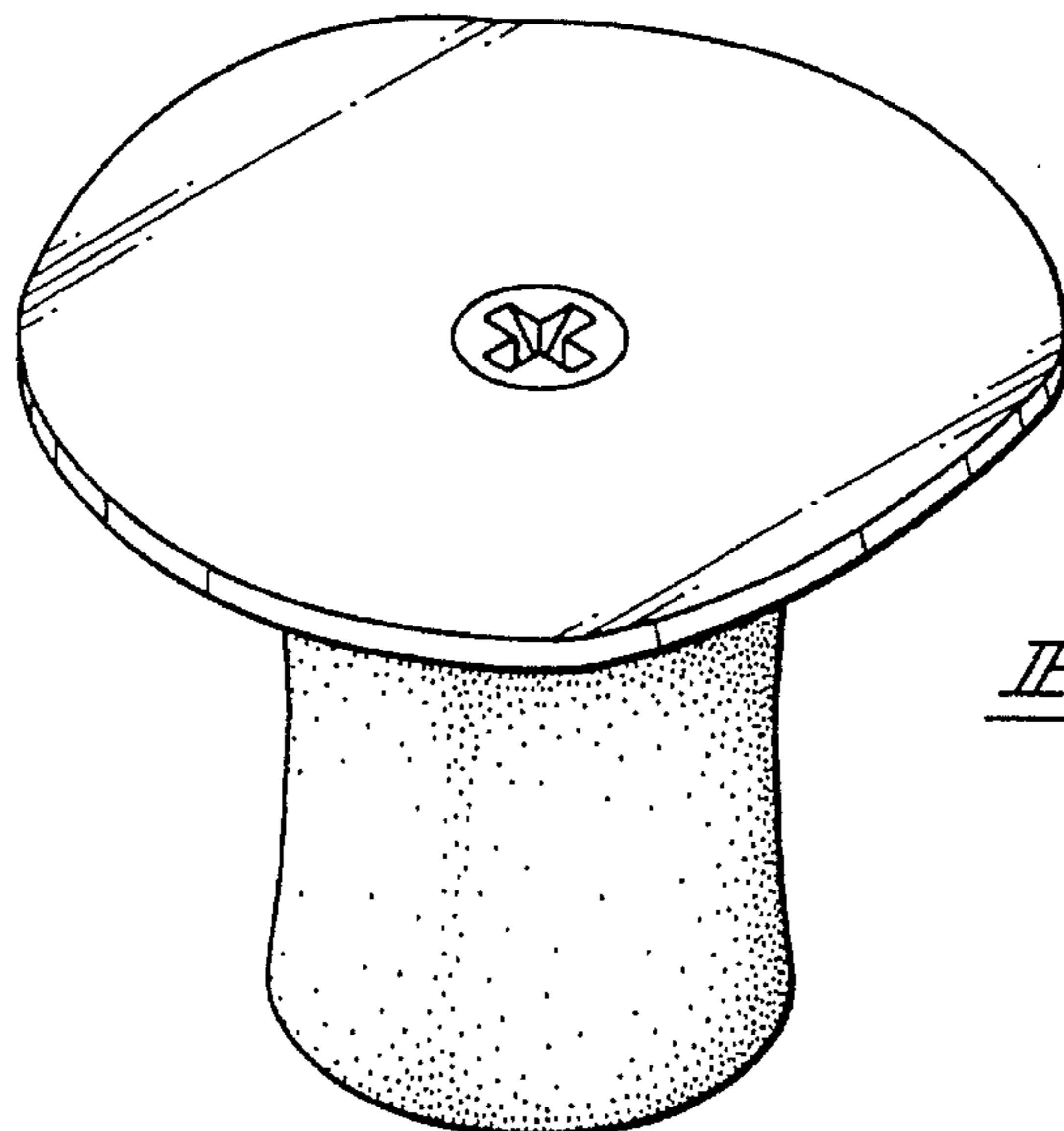

FIG. 100

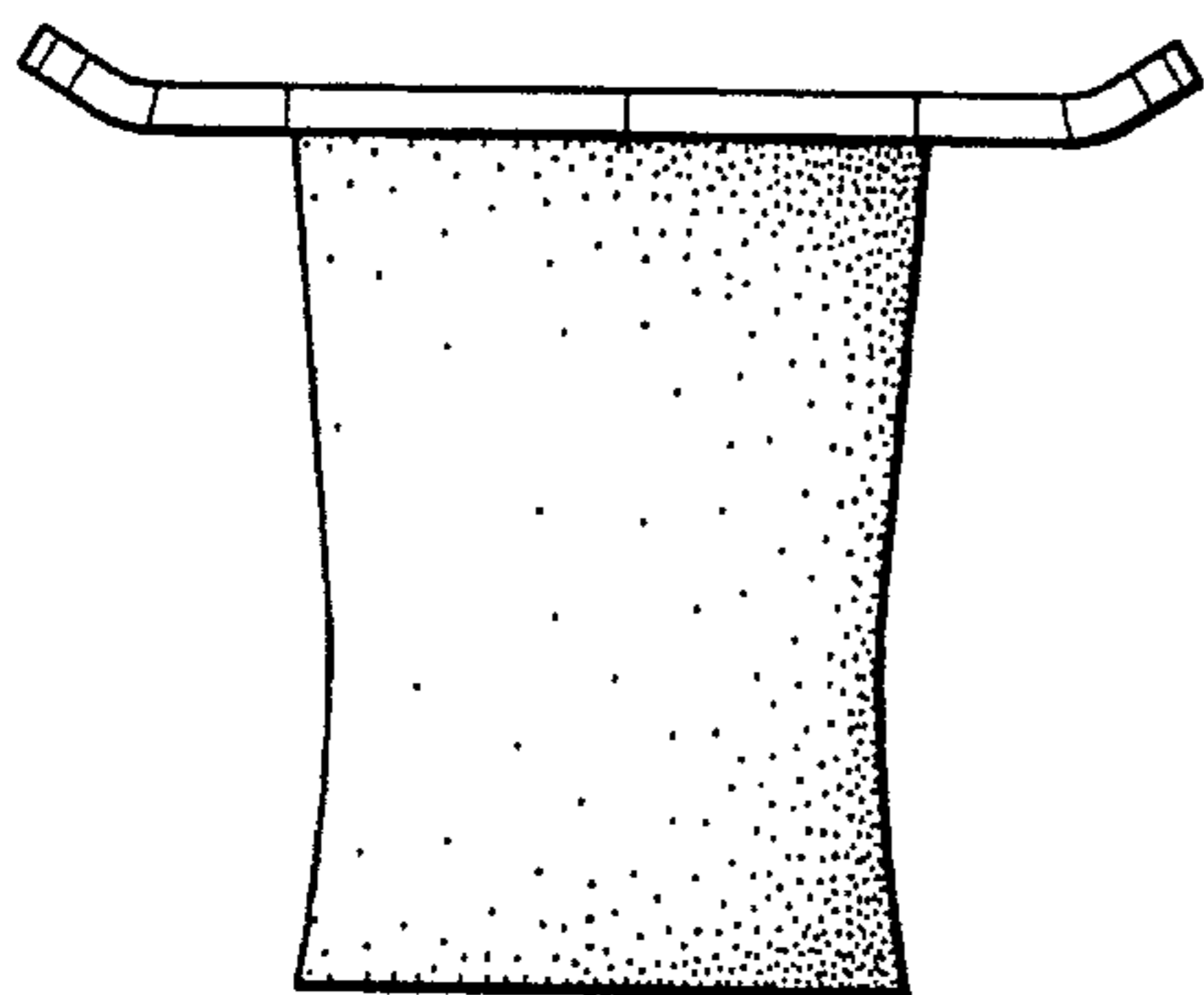

FIG. 101

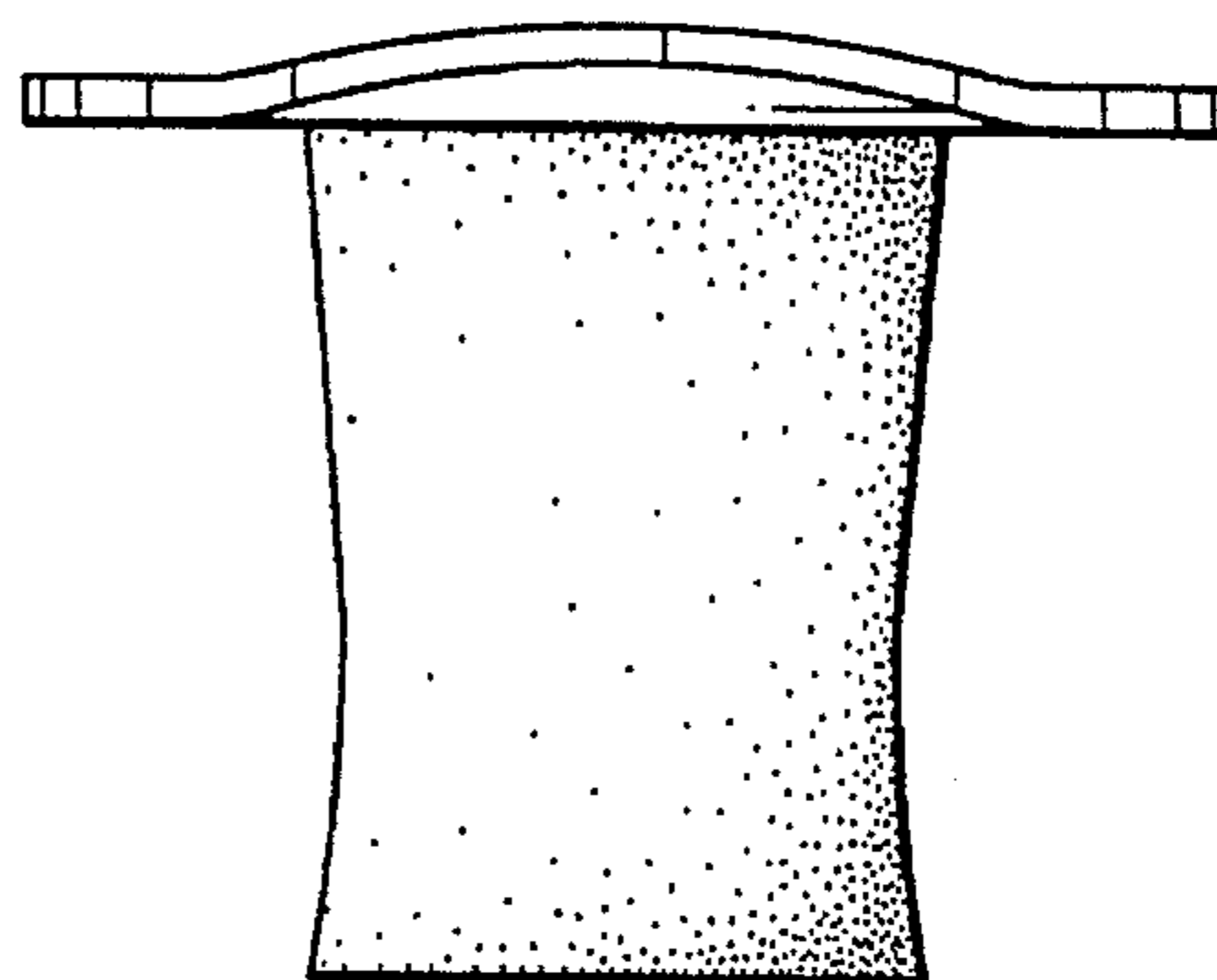

FIG. 102

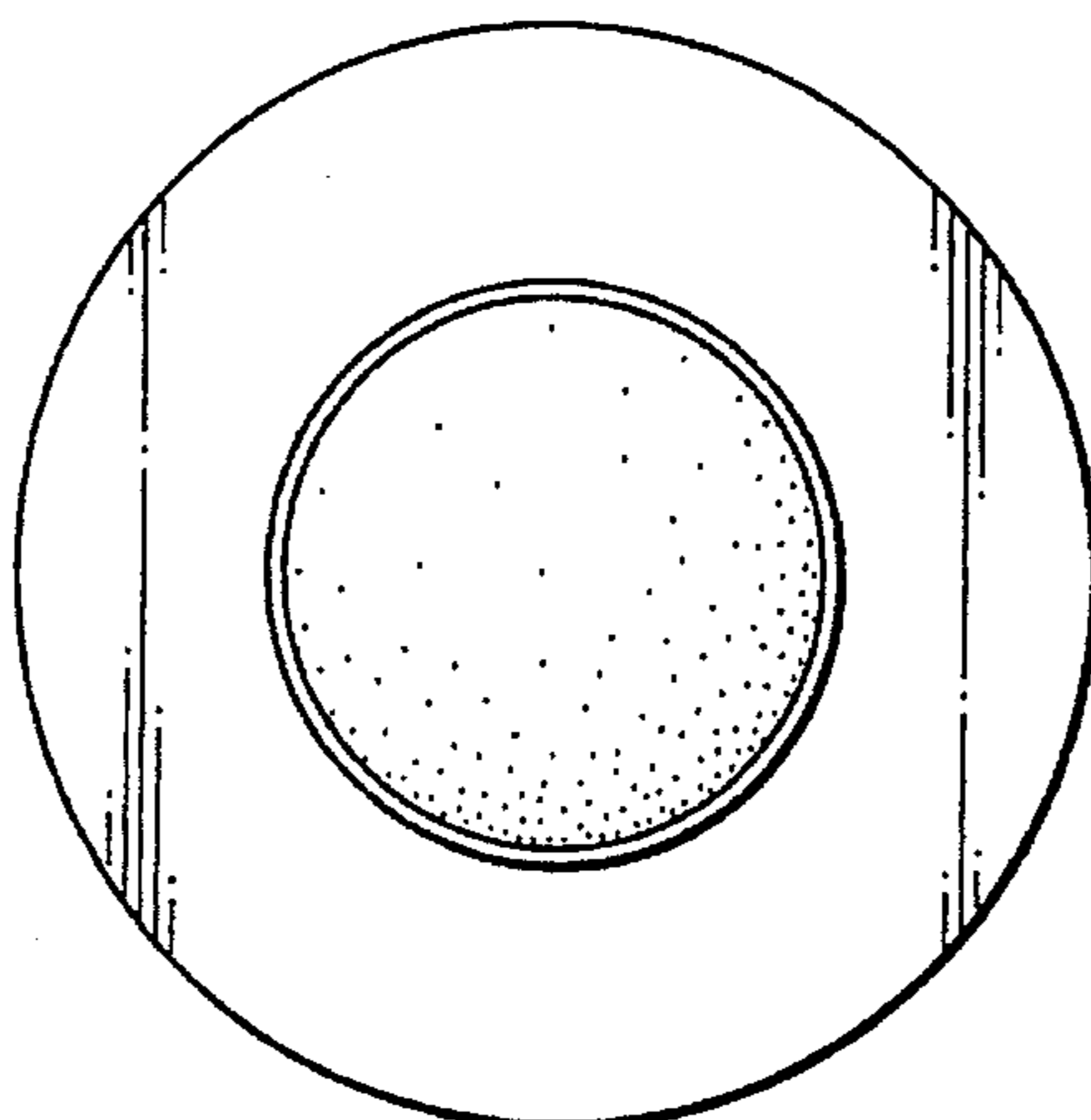

FIG. 103