



US00D376593S

United States Patent [19]

[11] Patent Number: **Des. 376,593**

Riggs

[45] Date of Patent: ****Dec. 17, 1996**

[54] **PORTABLE RADIO TRANSCEIVER**

Primary Examiner—B. J. Bullock
Assistant Examiner—Richelle Shelton
Attorney, Agent, or Firm—M. Mansour Ghomeshi

[75] Inventor: **Andrew J. Riggs**, Provo, Utah

[73] Assignee: **Motorola, Inc.**, Schaumburg, Ill.

[57] **CLAIM**

[**] Term: **14 Years**

The ornamental design for a portable radio transceiver, as shown and described.

[21] Appl. No.: **29,609**

DESCRIPTION

[22] Filed: **Oct. 11, 1994**

[52] U.S. Cl. **D14/137**

[58] Field of Search D14/124, 137,
D14/138, 155, 159, 188, 192-198, 257,
299, 230; 455/73, 89, 90, 100, 128, 347

FIG. 1 is front view of a portable radio transceiver showing my new design thereof;

FIG. 2 is a back view thereof;

FIG. 3 is a top view thereof;

FIG. 4 is a bottom plan view thereof;

FIG. 5 is a left view thereof;

FIG. 6 is a right side elevational view thereof; and,

FIG. 7 is a front, bottom, and right side isometric view thereof.

[56] References Cited

U.S. PATENT DOCUMENTS

| | | | | |
|------------|---------|--------------|-------|---------|
| D. 232,863 | 9/1974 | Tong | | D14/192 |
| D. 304,944 | 12/1989 | Behringer | | D14/188 |
| D. 325,207 | 4/1992 | Dix | | D14/188 |
| D. 355,416 | 2/1995 | McCay et al. | | D14/137 |

1 Claim, 4 Drawing Sheets

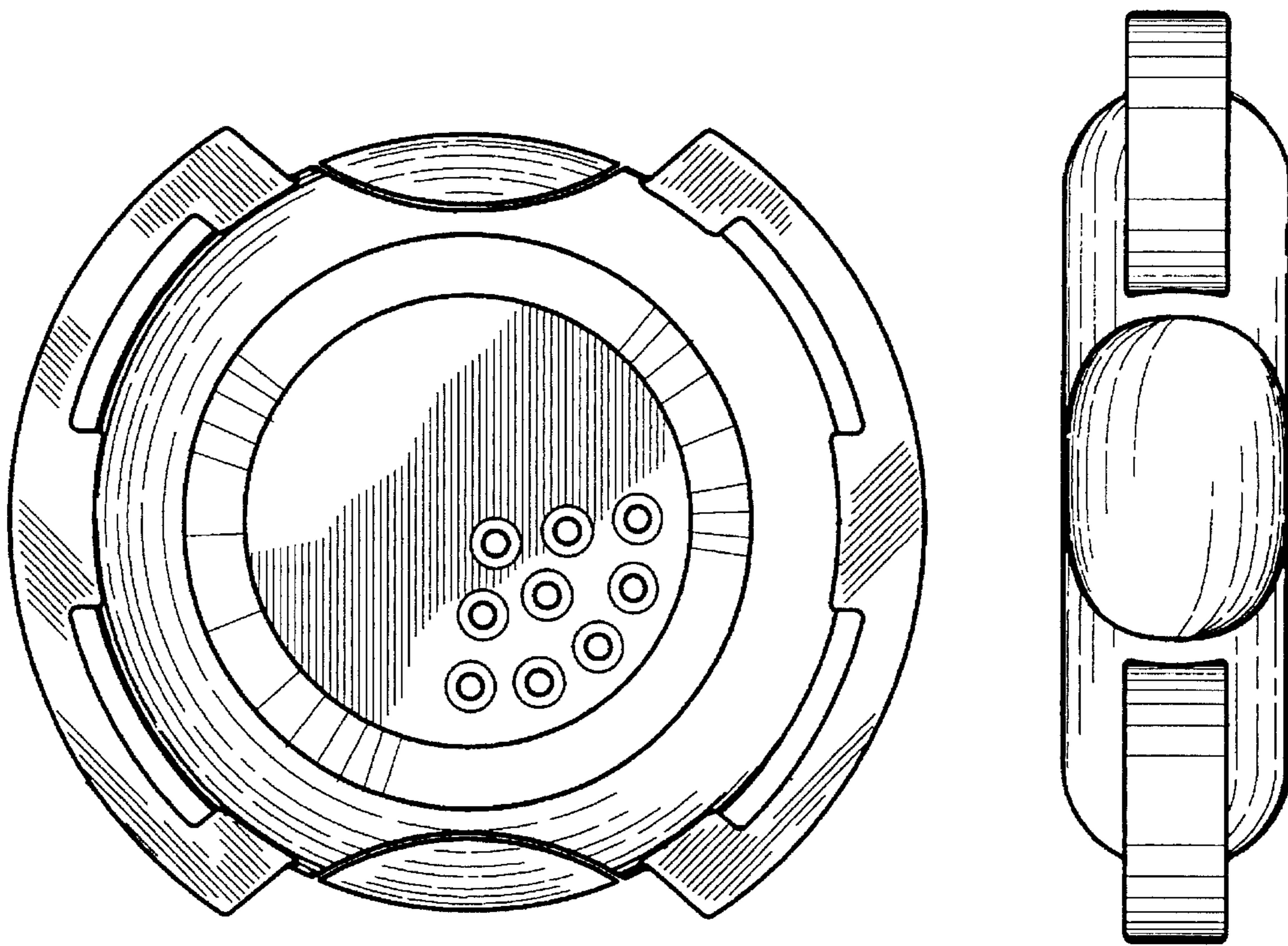

FIG. 2

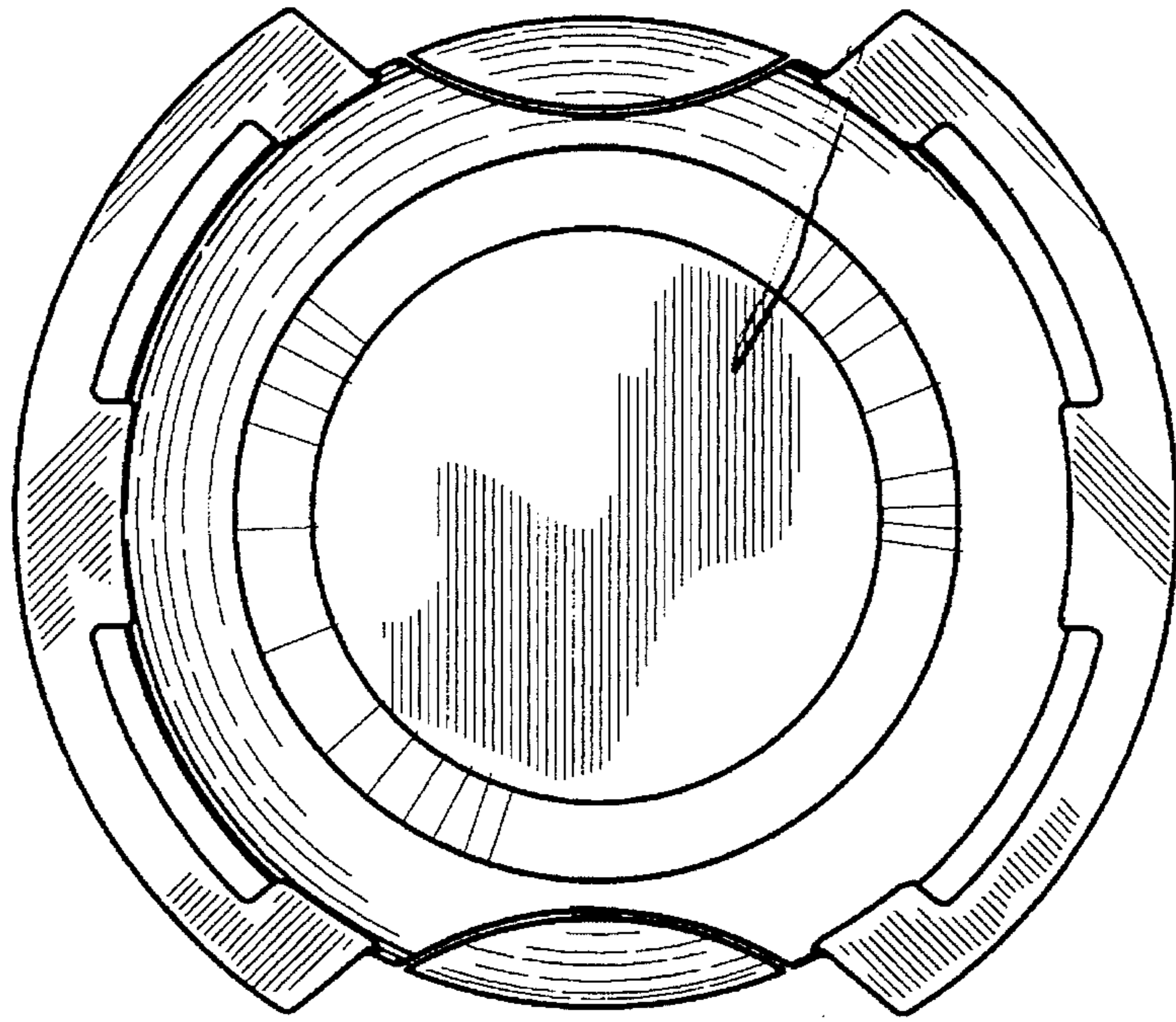

FIG. 1

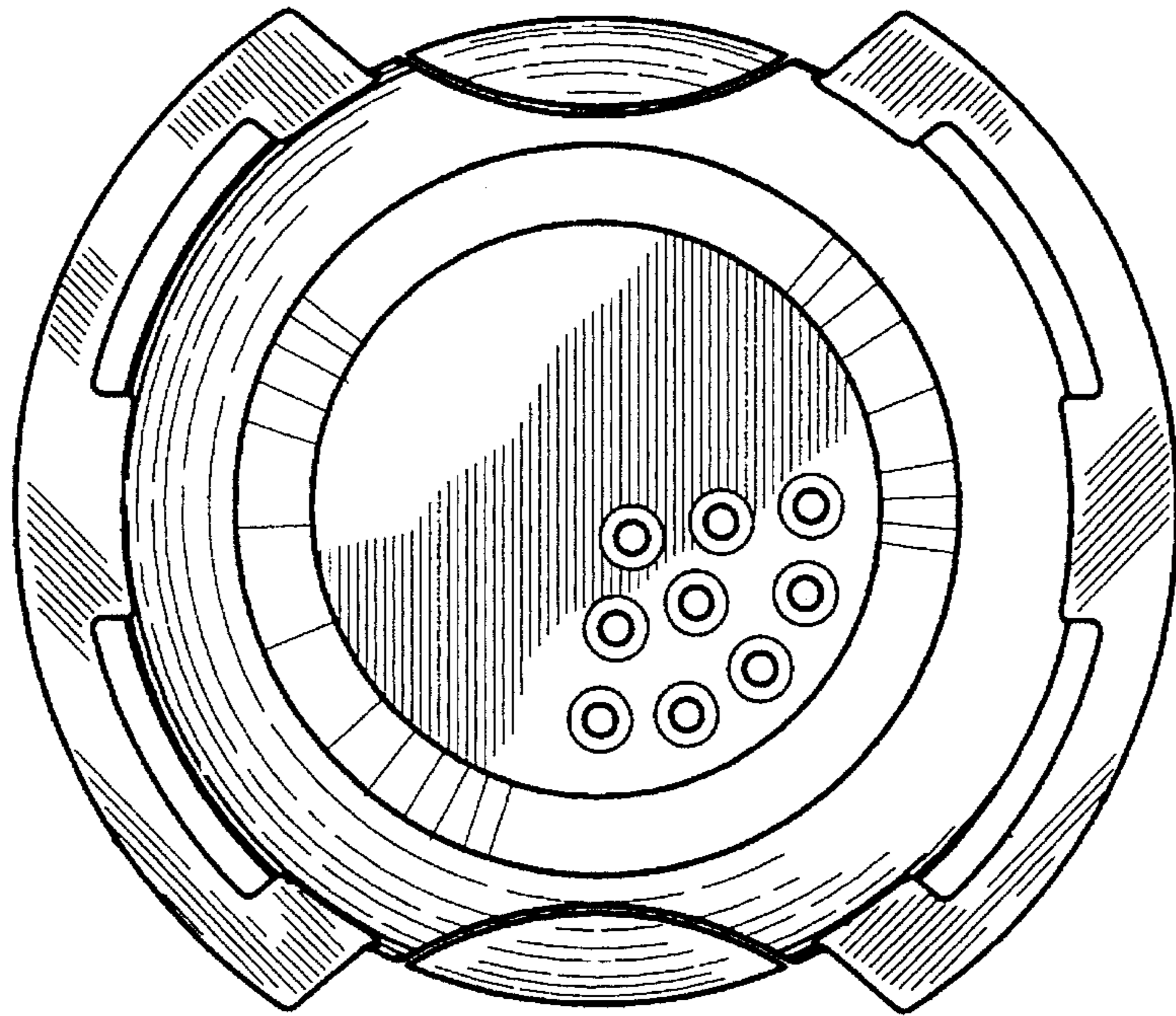

FIG. 4

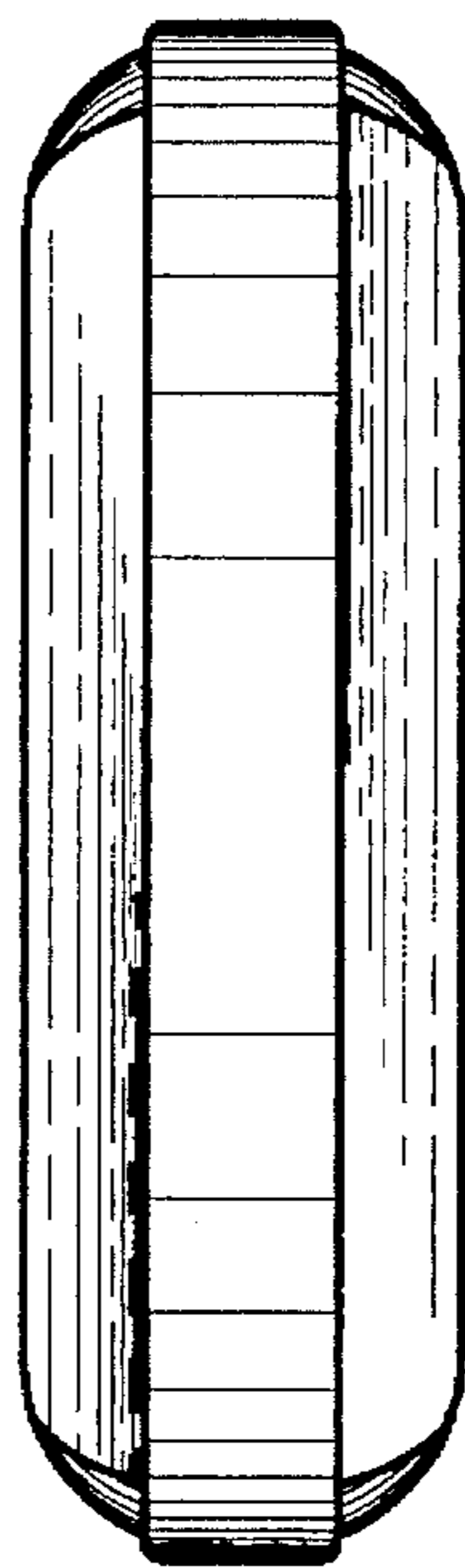

FIG. 3

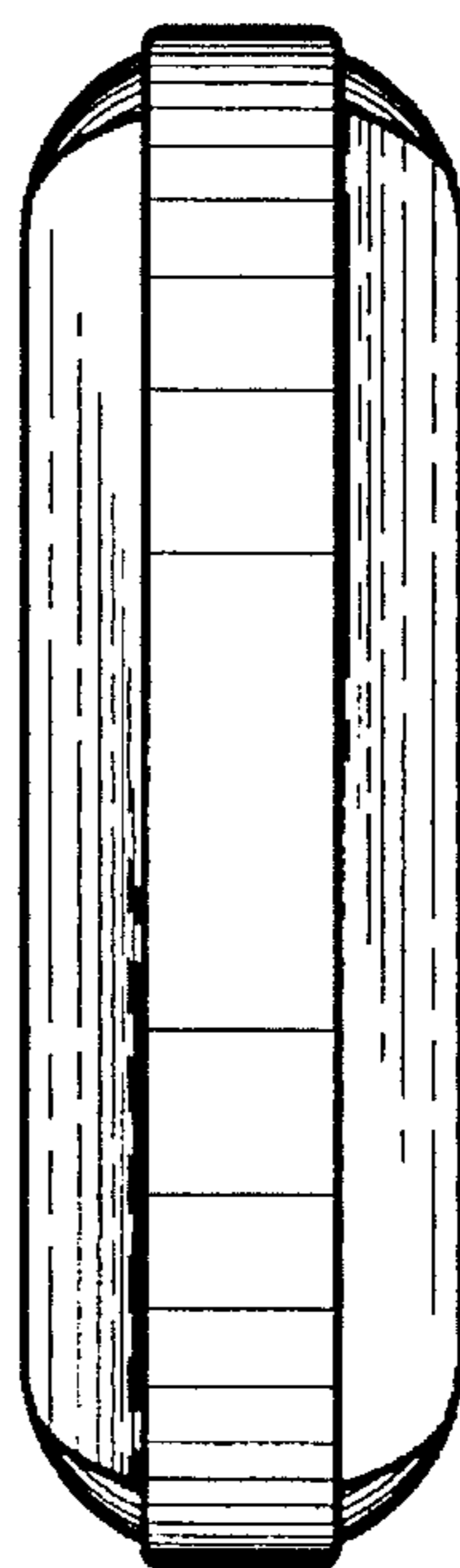

FIG. 6

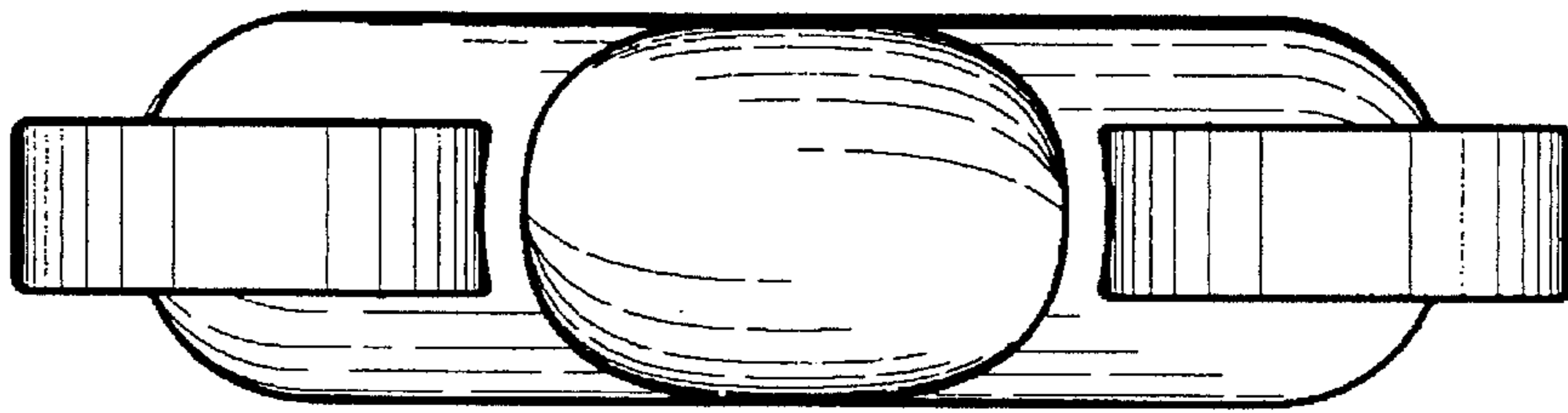

FIG. 5

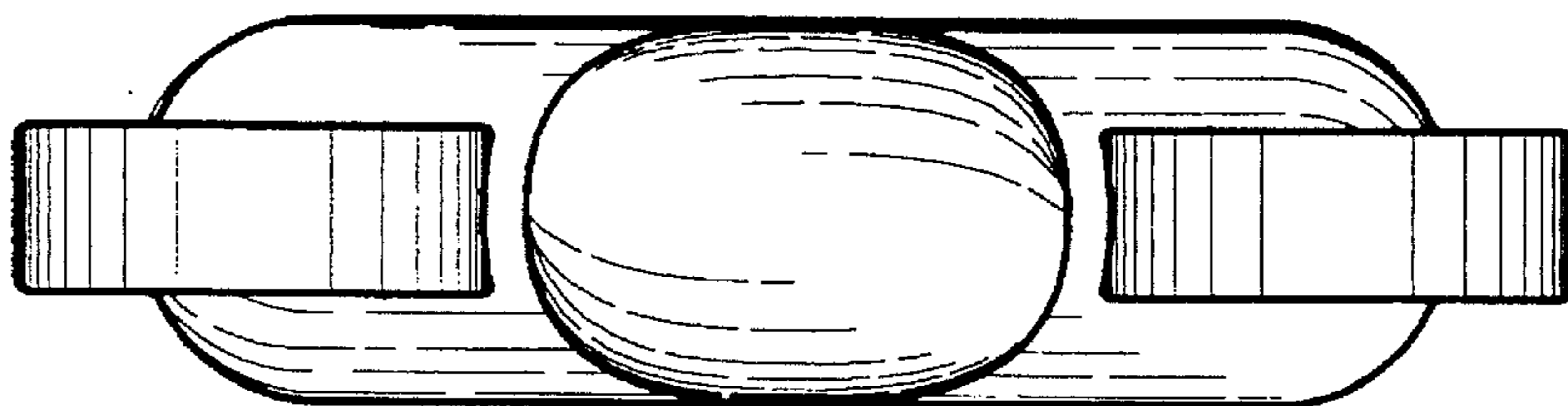

FIG. 7

