



US00D376465S

# United States Patent [19]

[11] Patent Number: Des. 376,465

Haro et al.

[45] Date of Patent: \*\*Dec. 17, 1996

## [54] SET OF LETTER-SHAPED PASTA

[75] Inventors: **Guillermo Haro**, Skokie; **Tara S. Peoples-Allen**, Chicago; **Ricardo Villota**, Lake Zurich; **Arturo Martinez**, Chicago; **Ricardo Gonzalez**, Glenview; **John E. Peluso**, Chicago, all of Ill.

[73] Assignee: **Kraft Foods, Inc.**, Northfield, Ill.

[\*\*] Term: **14 Years**

[21] Appl. No.: **46,469**

[22] Filed: **Nov. 15, 1995**

[52] U.S. Cl. .... **D1/114; D18/24; D1/126**

[58] Field of Search ..... **D1/120, 114, 106, D1/126, 199; D18/24, 26, 29, 30; 426/87, 104, 514**

## [56] References Cited

### U.S. PATENT DOCUMENTS

D. 10,765	8/1878	Fowler et al. ....	D1/114
D. 43,813	4/1913	Becker .	
D. 247,691	4/1978	Gnesi .	
D. 258,320	2/1981	Schilpp et al. ....	D1/114
D. 293,616	1/1988	Blatnick .	
D. 313,689	1/1991	Epstein .....	D1/114
D. 352,372	11/1994	Gonzalez .	
3,122,684	2/1964	Genin .....	D18/244

### OTHER PUBLICATIONS

Womans Day, Nov. 1952, p.195, Alphabets in soup.

*Primary Examiner*—Susan J. Lucas

*Assistant Examiner*—Pamela Burgess

*Attorney, Agent, or Firm*—Fitch, Even, Tabin & Flannery

## [57] CLAIM

The ornamental design for a set of letter-shaped pasta, as shown and described.

## DESCRIPTION

FIG. 1 is a top plan view of a set of letter-shaped pasta showing a first embodiment of our new design;

FIG. 2 is a front elevational view thereof, the rear elevational view being identical;

FIG. 3 is a right-side elevational view thereof, the left-side view being identical;

FIG. 4 is a bottom plan view thereof;

FIG. 5 is a top plan view of a letter-shaped pasta showing a second embodiment of our new design, the bottom plan view being identical;

FIG. 6 is a left-side elevational view thereof;

FIG. 7 is a front elevational view thereof, the rear elevational view being a mirror image;

FIG. 8 is a right-side elevational view thereof;

FIG. 9 is a top plan view of a letter-shaped pasta showing a third embodiment of our new design; the bottom plan view being identical;

FIG. 10 is a left-side elevational view thereof;

FIG. 11 is a front elevational view thereof, the rear elevational view being a mirror image;

FIG. 12 is a right-side elevational view thereof;

FIG. 13 is a top plan view of a letter-shaped pasta showing a fourth embodiment of our new design, the bottom plan view being identical;

FIG. 14 is a left-side elevational view thereof;

FIG. 15 is a front elevational view thereof, the rear elevational view being a mirror image;

FIG. 16 is a right-side elevational view thereof;

FIG. 17 is a top plan view of a letter-shaped pasta showing a fifth embodiment of our new design, the bottom plan view being identical;

FIG. 18 is a left-side elevational view thereof;

FIG. 19 is a front elevational view thereof, the rear elevational view being a mirror image;

FIG. 20 is a right side elevational view thereof;

FIG. 21 is a top plan view of a letter-shaped pasta showing a sixth embodiment of our new design;

FIG. 22 is a left-side elevational view thereof;

FIG. 23 is a front elevational view thereof, the rear elevational view being a mirror image;

FIG. 24 is a bottom plan view thereof;

FIG. 25 is a right-side elevational view thereof;

FIG. 26 is a top plan view of a letter-shaped pasta in accordance with a seventh embodiment of our new design, the bottom plan view being identical;

FIG. 27 is a left-side elevational view thereof;

FIG. 28 is a front elevational view thereof, the rear elevational view being a mirror image;

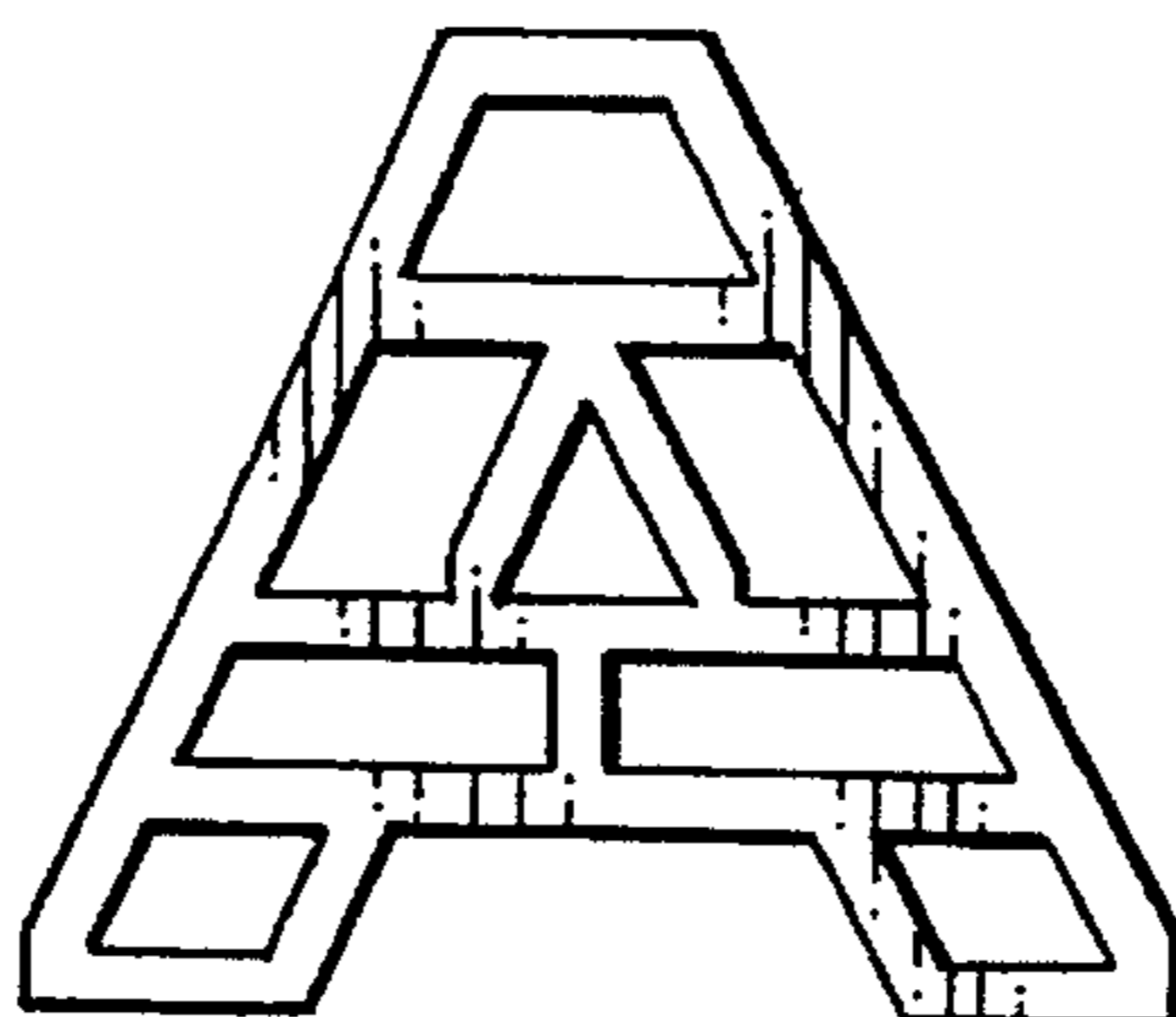




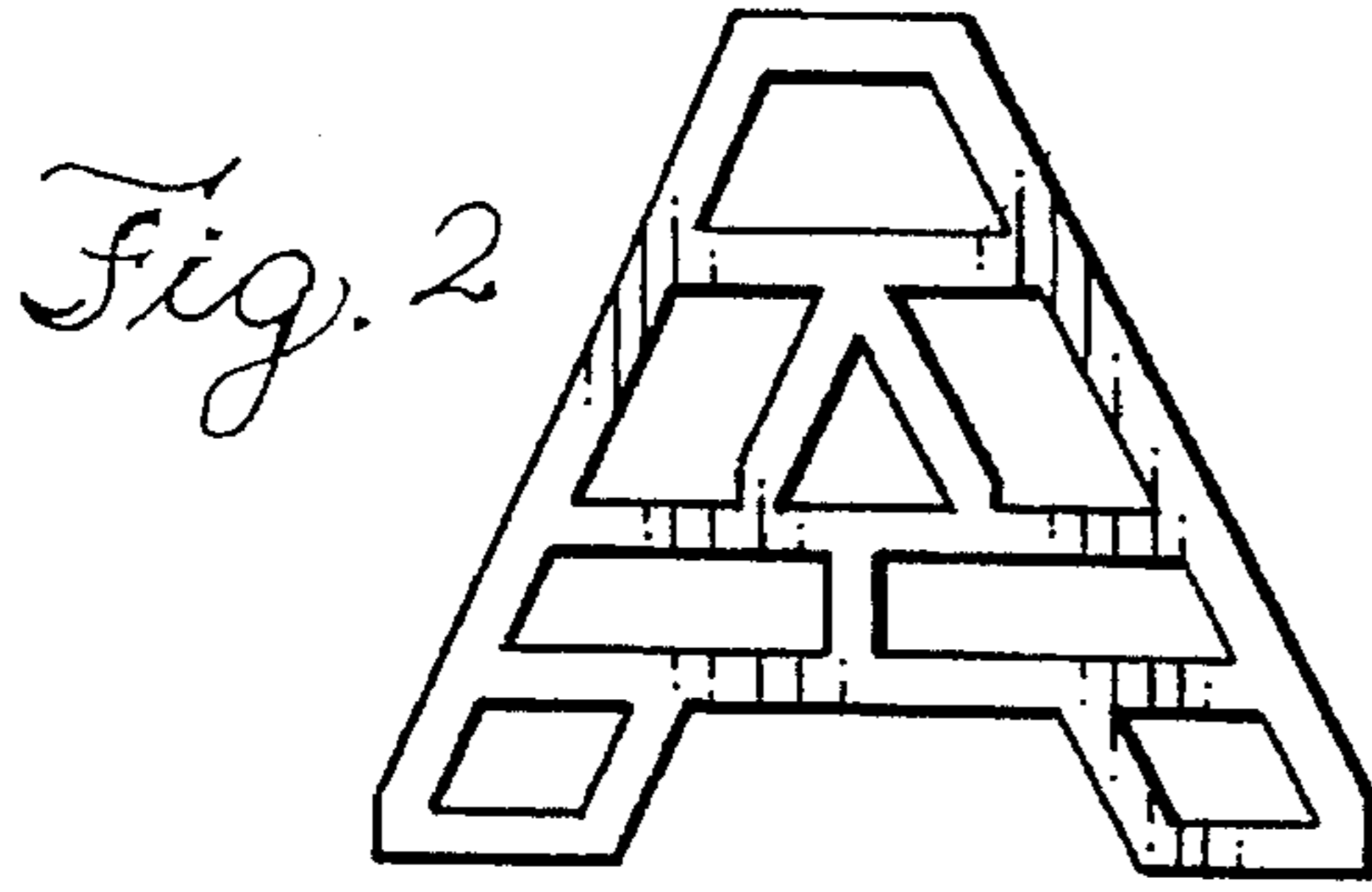
FIG. 29 is a right-side elevational view thereof;  
FIG. 30 is a top plan view of a letter-shaped pasta showing an eighth embodiment of our new design, the bottom view being identical;  
FIG. 31 is a left-side elevational view thereof, the right-side elevational view being identical;  
FIG. 32 is a front elevational view thereof, the rear elevational view being identical;  
FIG. 33 is a top plan view of a letter-shaped pasta showing a ninth embodiment of our new design, the bottom plan view being identical;  
FIG. 34 is a front elevational view thereof, the rear elevational view being identical;  
FIG. 35 is a right-side elevational view thereof, the left-side elevational view being identical;  
FIG. 36 is a top plan view of a letter-shaped pasta showing a tenth embodiment of our new design;  
FIG. 37 is a left-side elevational view thereof;  
FIG. 38 is a front elevational view thereof, the rear elevational view being a mirror image;  
FIG. 39 is a right-side elevational view thereof;  
FIG. 40 is a bottom plan view thereof;  
FIG. 41 is a top plan view of a letter-shaped pasta showing an eleventh embodiment of our new design, the bottom plan view being identical;  
FIG. 42 is a left-side elevational view thereof;  
FIG. 43 is a front elevational view thereof, the rear elevational view being a mirror image;  
FIG. 44 is a right-side elevational view thereof;  
FIG. 45 is a bottom plan view thereof;  
FIG. 46 is a top plan view of a letter-shaped pasta showing a twelfth embodiment of our new design;  
FIG. 47 is a left-side elevational view thereof;  
FIG. 48 is a front elevational view thereof, the rear elevational view being a mirror image;  
FIG. 49 is a right-side elevational view thereof;  
FIG. 50a is a bottom plan view thereof;  
FIG. 50b is a top plan view of a letter-shaped pasta showing a thirteenth embodiment of our new design;  
FIG. 51 is a left-side elevational view thereof, the right-side elevational view being identical;  
FIG. 52 is a front elevational view thereof, the rear elevational view being identical;  
FIG. 53 is a bottom plan view thereof;  
FIG. 54 is a top plan view of a letter-shaped pasta showing a fourteenth embodiment of our new design;  
FIG. 55 is a front elevational view thereof, the rear elevational view being a mirror image;  
FIG. 56 is a right-side elevational view thereof, the left-side elevational view being identical;  
FIG. 57 is a bottom plan view thereof;  
FIG. 58 is a top plan view of a letter-shaped pasta showing a fifteenth embodiment of our new design, the bottom plan view being identical;  
FIG. 59 is a left-side elevational view thereof, the right-side elevational view being identical;  
FIG. 60 is a front elevational view thereof, the rear elevational view being identical;  
FIG. 61 is a top plan view of a letter-shaped pasta showing a sixteenth embodiment of our new design;  
FIG. 62 is a left-side elevational view thereof;  
FIG. 63 is a front elevational view thereof, the rear elevational view being a mirror image;

FIG. 64 is a right-side elevational view thereof;  
FIG. 65 is a bottom plan view thereof;  
FIG. 66 is a top plan view of a letter-shaped pasta showing a seventeenth embodiment of our new design;  
FIG. 67 is a left-side elevational view thereof;  
FIG. 68 is a front elevational view thereof, the rear elevational view being a mirror image;  
FIG. 69 is a right-side elevational view thereof;  
FIG. 70 is a bottom plan view thereof;  
FIG. 71 is a top plan view of a letter-shaped pasta showing an eighteenth embodiment of our new design;  
FIG. 72 is a left-side elevational view thereof;  
FIG. 73 is a front elevational view thereof, the rear elevational view being a mirror image;  
FIG. 74 is a right-side elevational view thereof;  
FIG. 75 is a bottom plan view thereof;  
FIG. 76 is a top plan view of a letter-shaped pasta showing a nineteenth embodiment of our new design, the bottom plan view being identical;  
FIG. 77 is a left-side elevational view thereof;  
FIG. 78 is a front elevational view thereof, the rear elevational view being a mirror image;  
FIG. 79 is a right-side elevational view thereof;  
FIG. 80 is a top plan view of a letter-shaped pasta showing a twentieth embodiment of our new design;  
FIG. 81 is a left-side elevational view thereof, the right-side elevational view being identical;  
FIG. 82 is a front elevational view thereof, the rear elevational view being identical;  
FIG. 83 is a bottom plan view thereof;  
FIG. 84 is a top plan view of a letter-shaped pasta showing a twenty-first embodiment of our new design;  
FIG. 85 is a left-side elevational view thereof, the right-side elevational view being identical;  
FIG. 86 is a front elevational view thereof, the rear elevational view being identical;  
FIG. 87 is a bottom plan view thereof;  
FIG. 88 is a top plan view of a letter-shaped pasta showing a twenty-second embodiment of our new design;  
FIG. 89 is a front elevational view thereof;  
FIG. 90 is a right-side elevational view thereof, the left-side elevational view being identical;  
FIG. 91 is a bottom plan view thereof;  
FIG. 92 is a front elevational view of a letter-shaped pasta showing a twenty-third embodiment of our new design, the rear elevational view being identical;  
FIG. 93 is a right-side elevational view thereof, the left-side elevational view being identical;  
FIG. 94 is a bottom plan view thereof, the top plan view being identical;  
FIG. 95 is a top plan view of a letter-shaped pasta showing a twenty-fourth embodiment of our new design;  
FIG. 96 is a left-side elevational view thereof, the right-side elevational view being identical;  
FIG. 97 is a front elevational view thereof, the rear elevational view being identical; and,  
FIG. 98 is a bottom plan view thereof.

It is understood that the figures are shown separately for clarity of illustration only and the separate embodiment comprise a set.



*Fig. 1*



*Fig. 2*



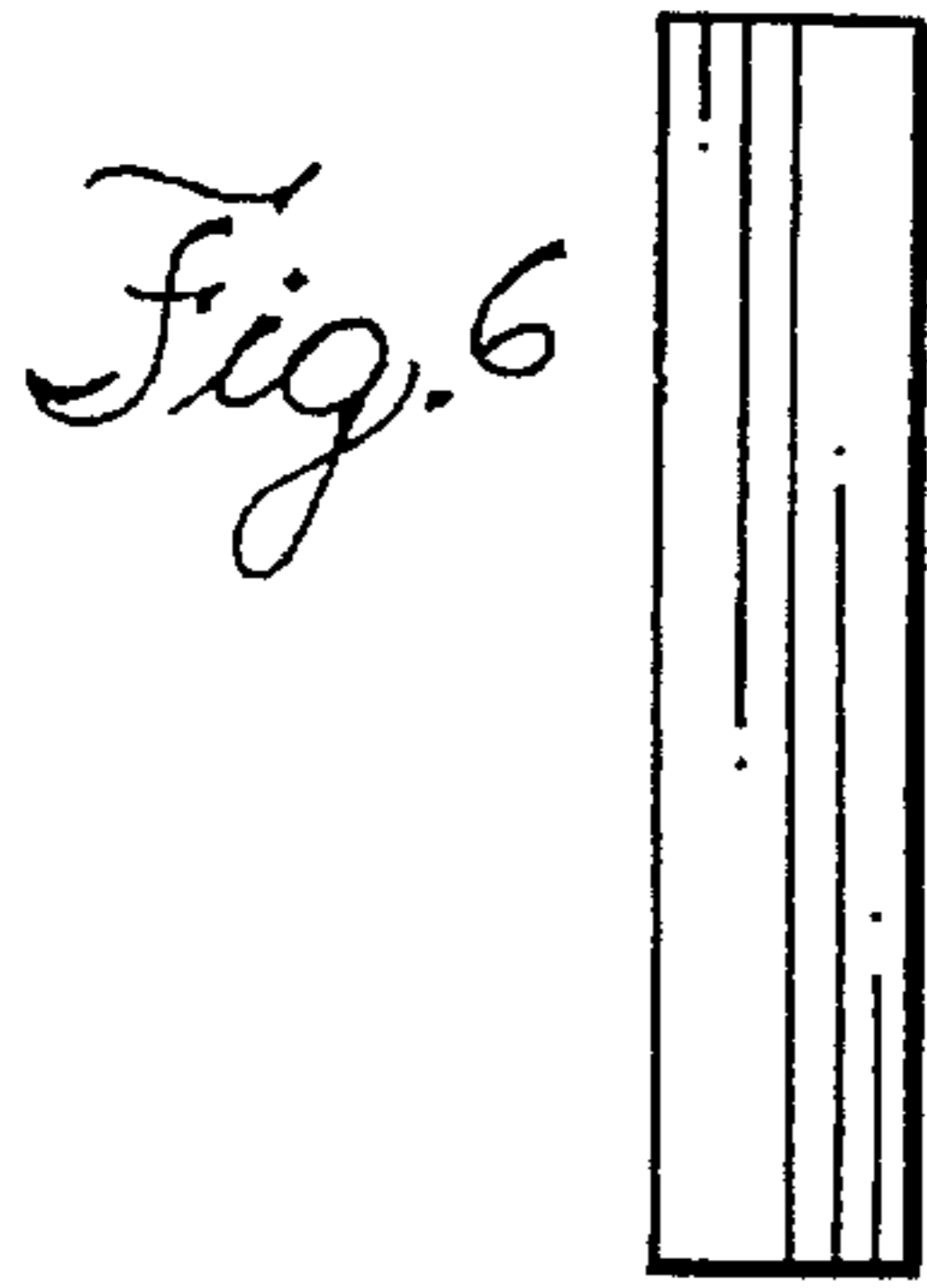
*Fig. 3*



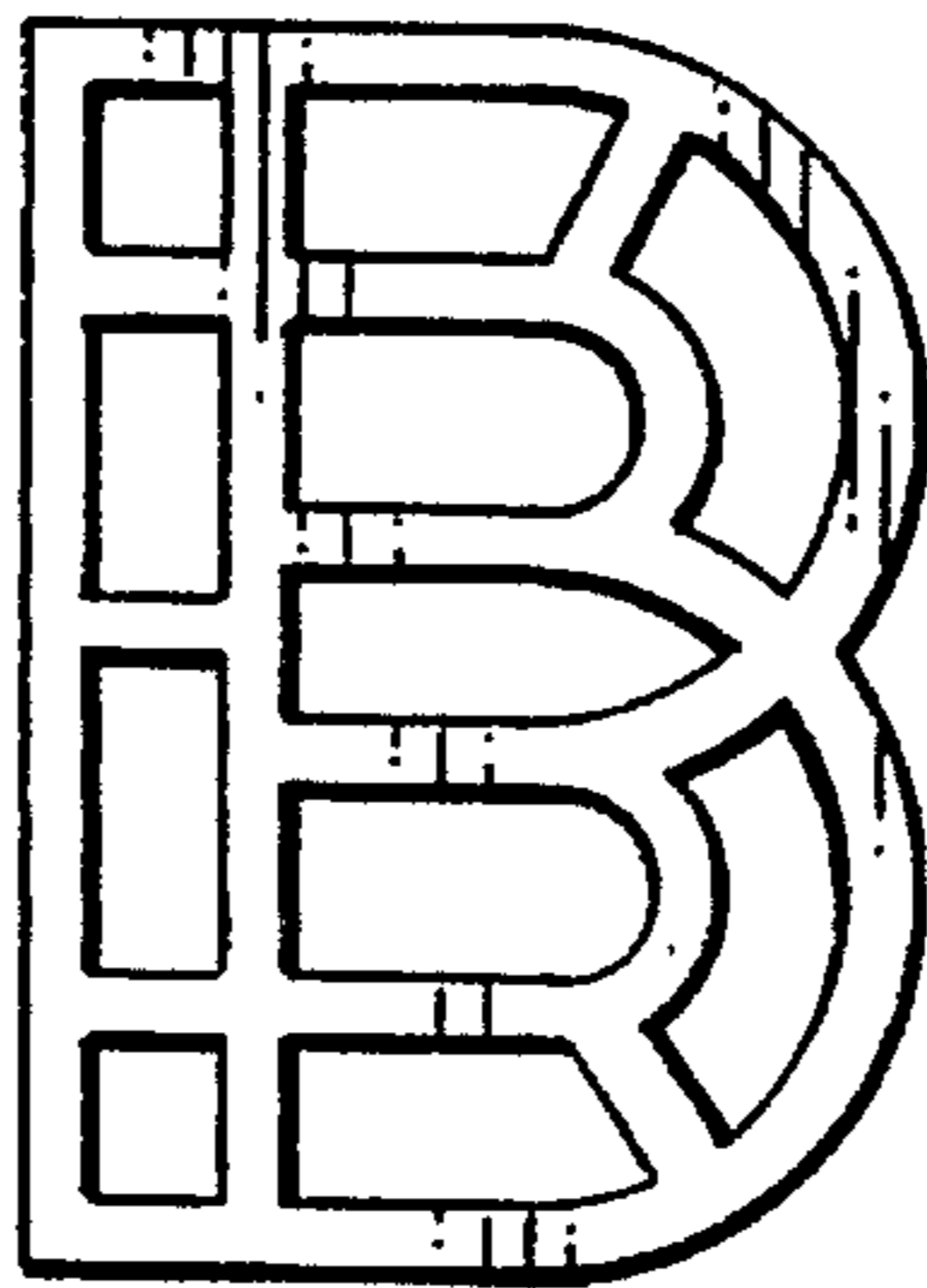
*Fig. 4*



*Fig. 5*



*Fig. 6*



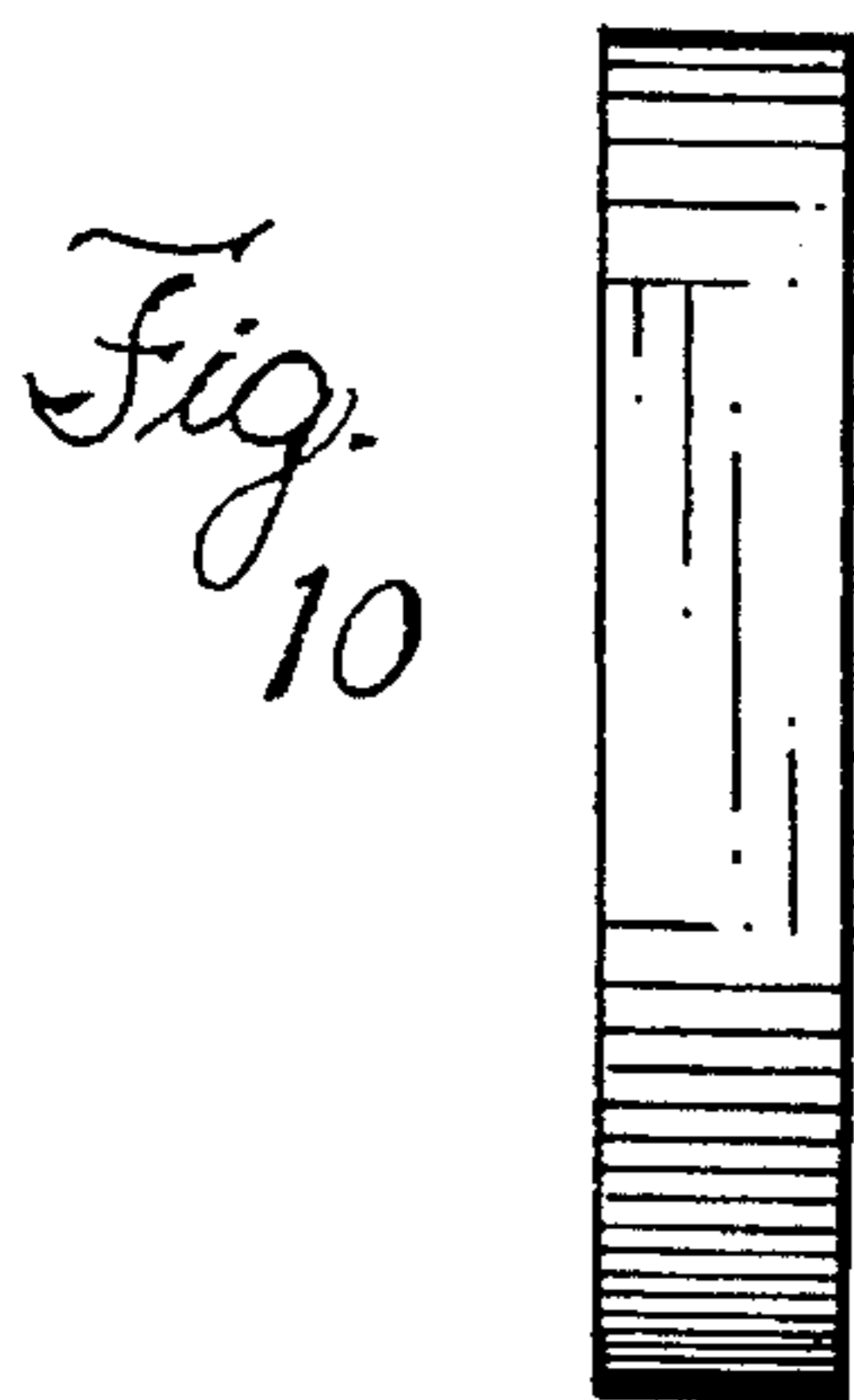
*Fig. 7*



*Fig. 8*

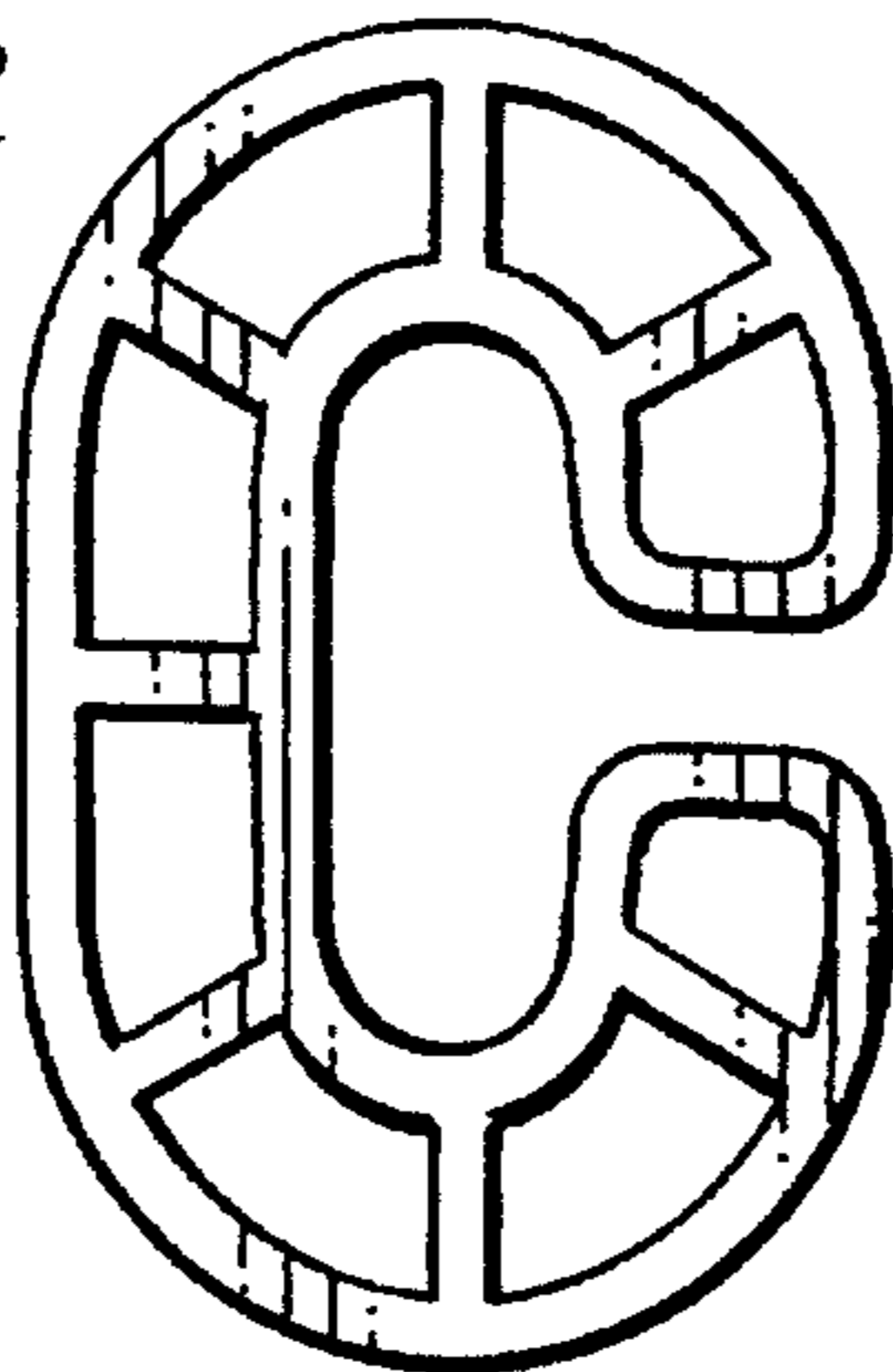


*Fig. 9*



*Fig. 10*

*Fig. 11*



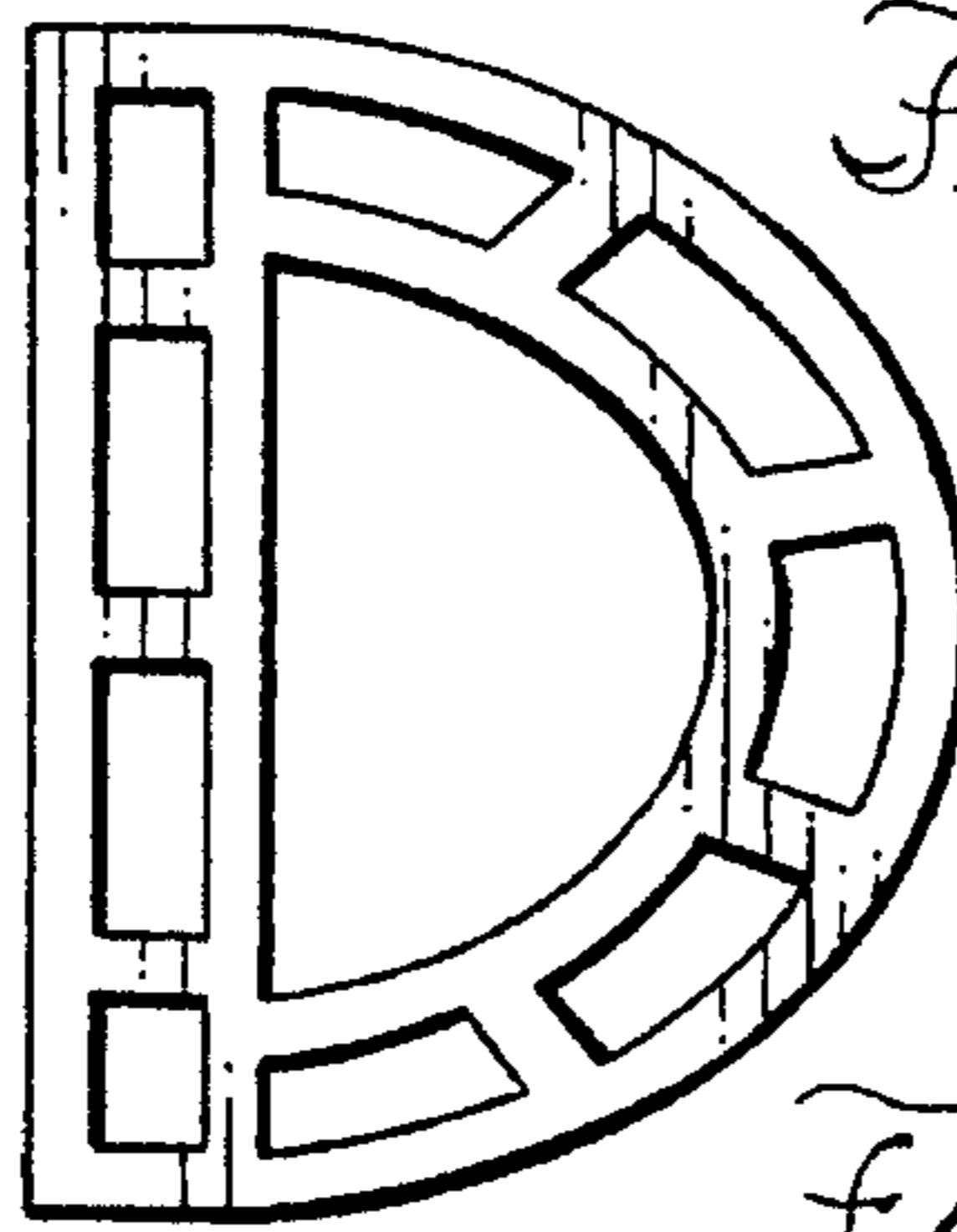
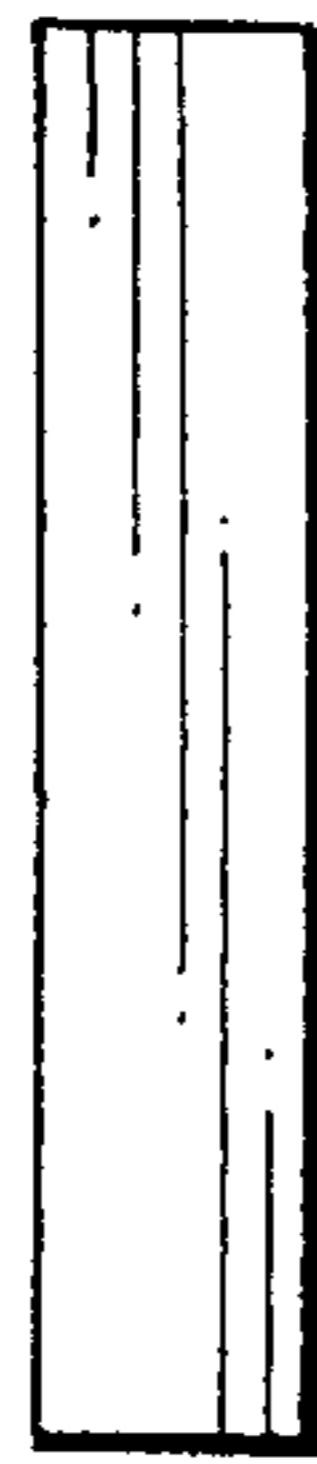
*Fig. 12*





*Fig. 13*

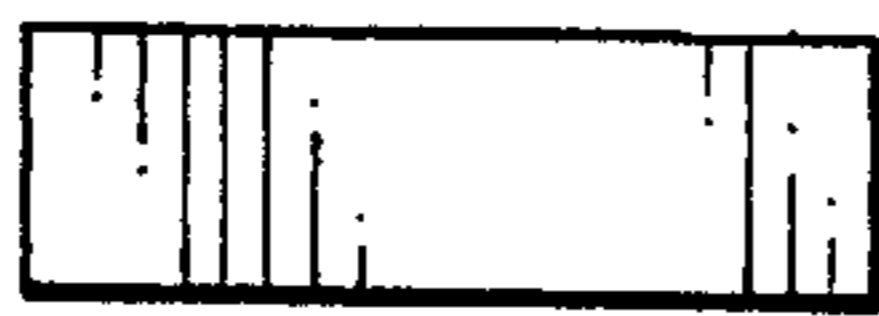
*Fig. 14*



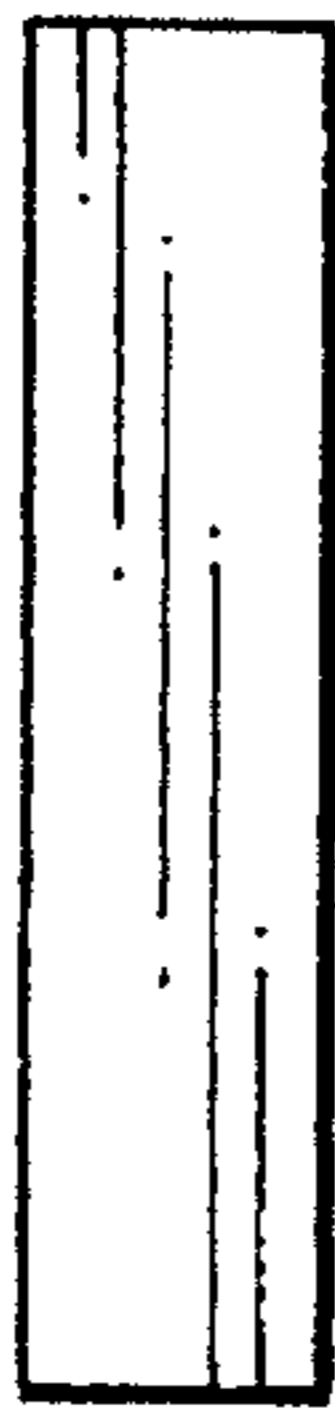
*Fig. 15*



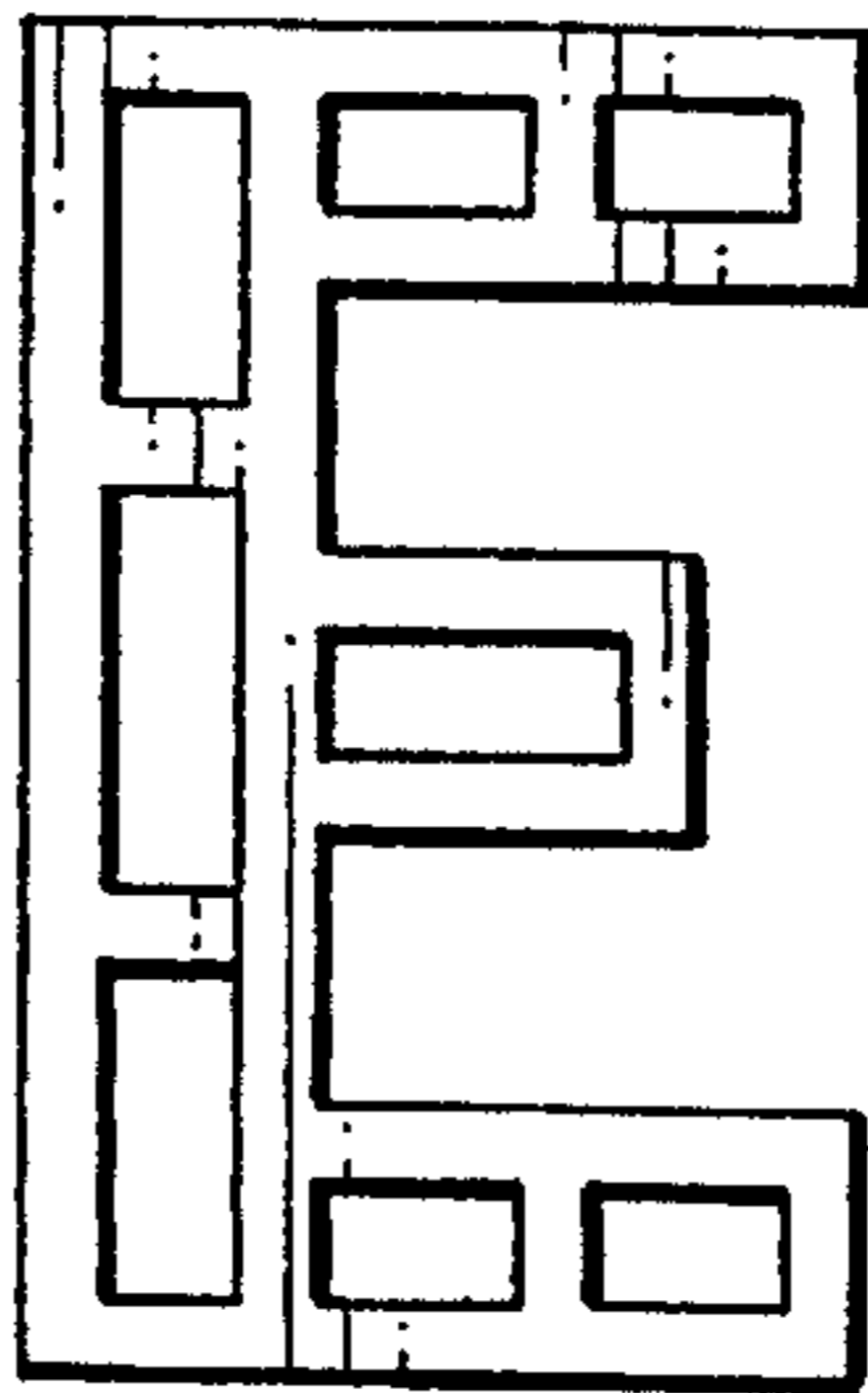
*Fig. 16*



*Fig. 17*



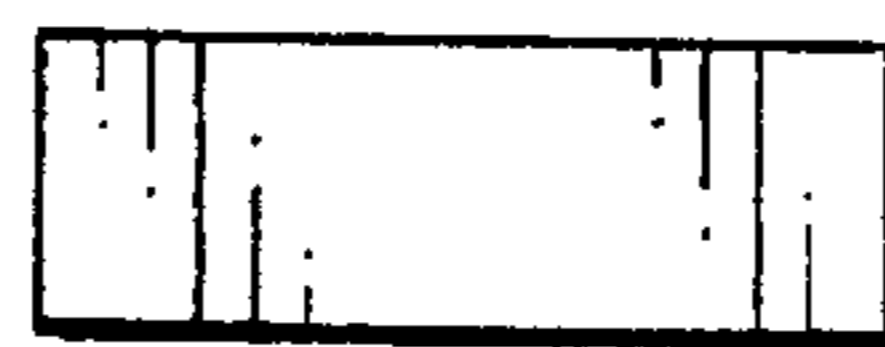
*Fig. 18*



*Fig. 19*

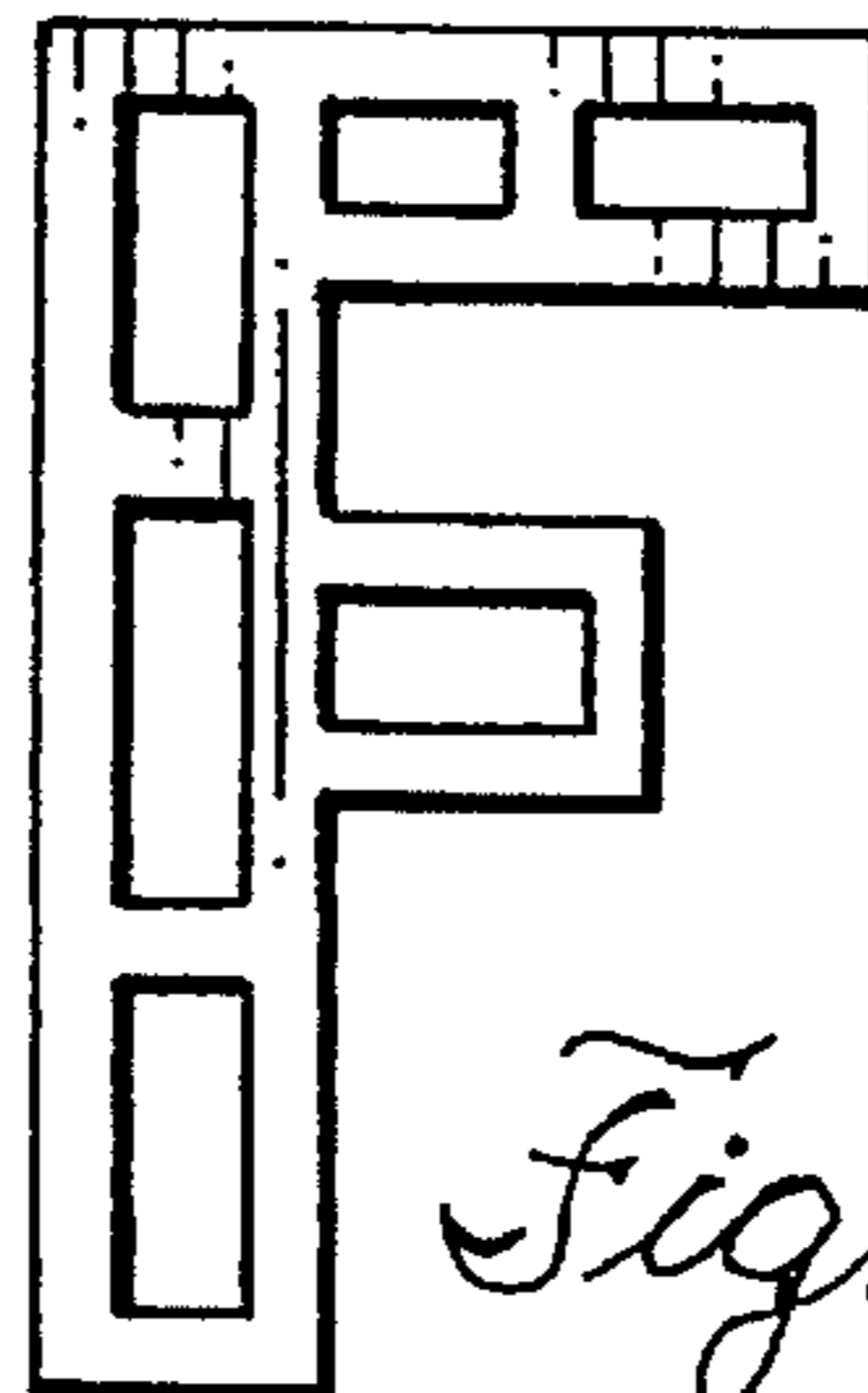


*Fig. 20*



*Fig. 21*

*Fig. 22*



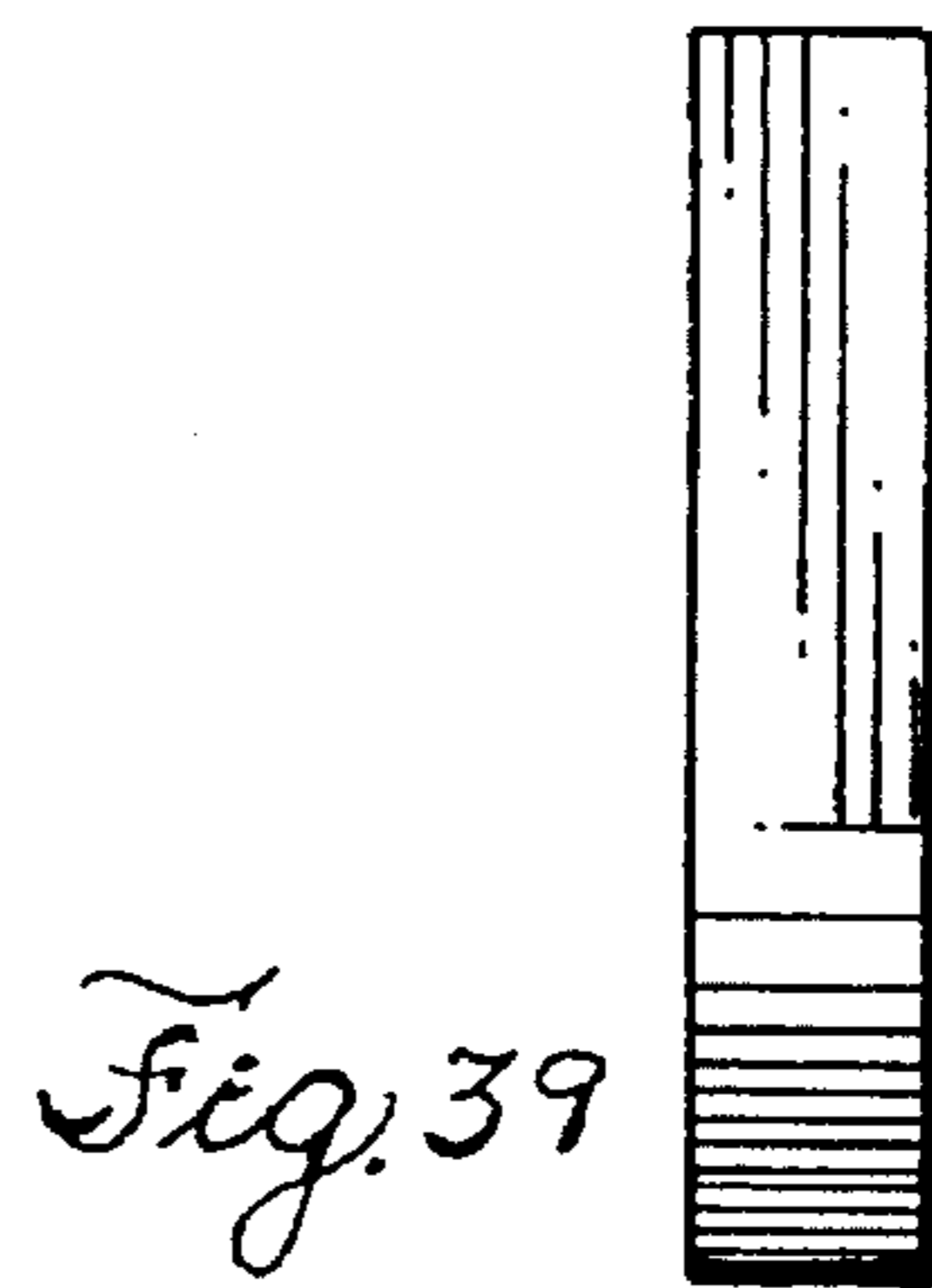
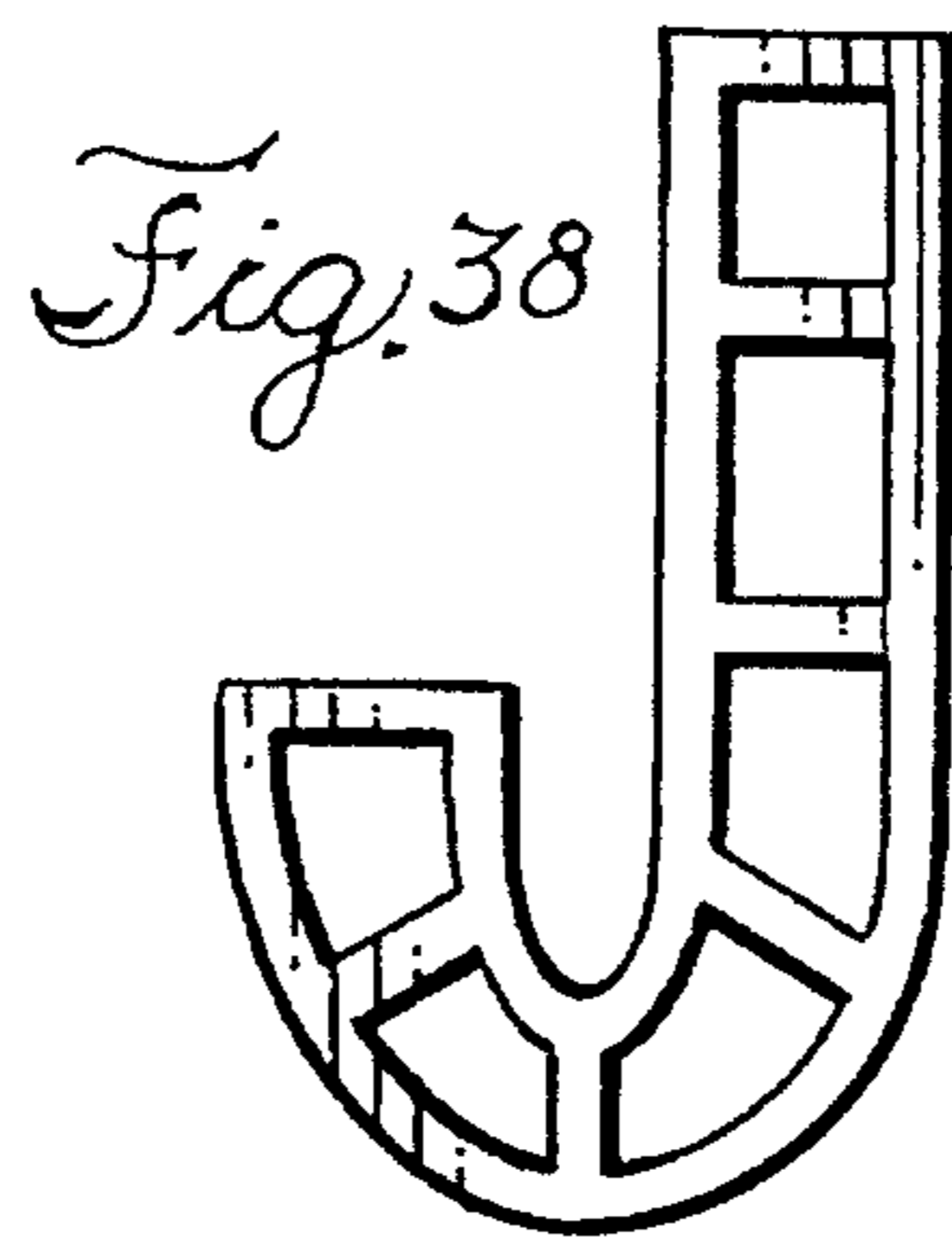
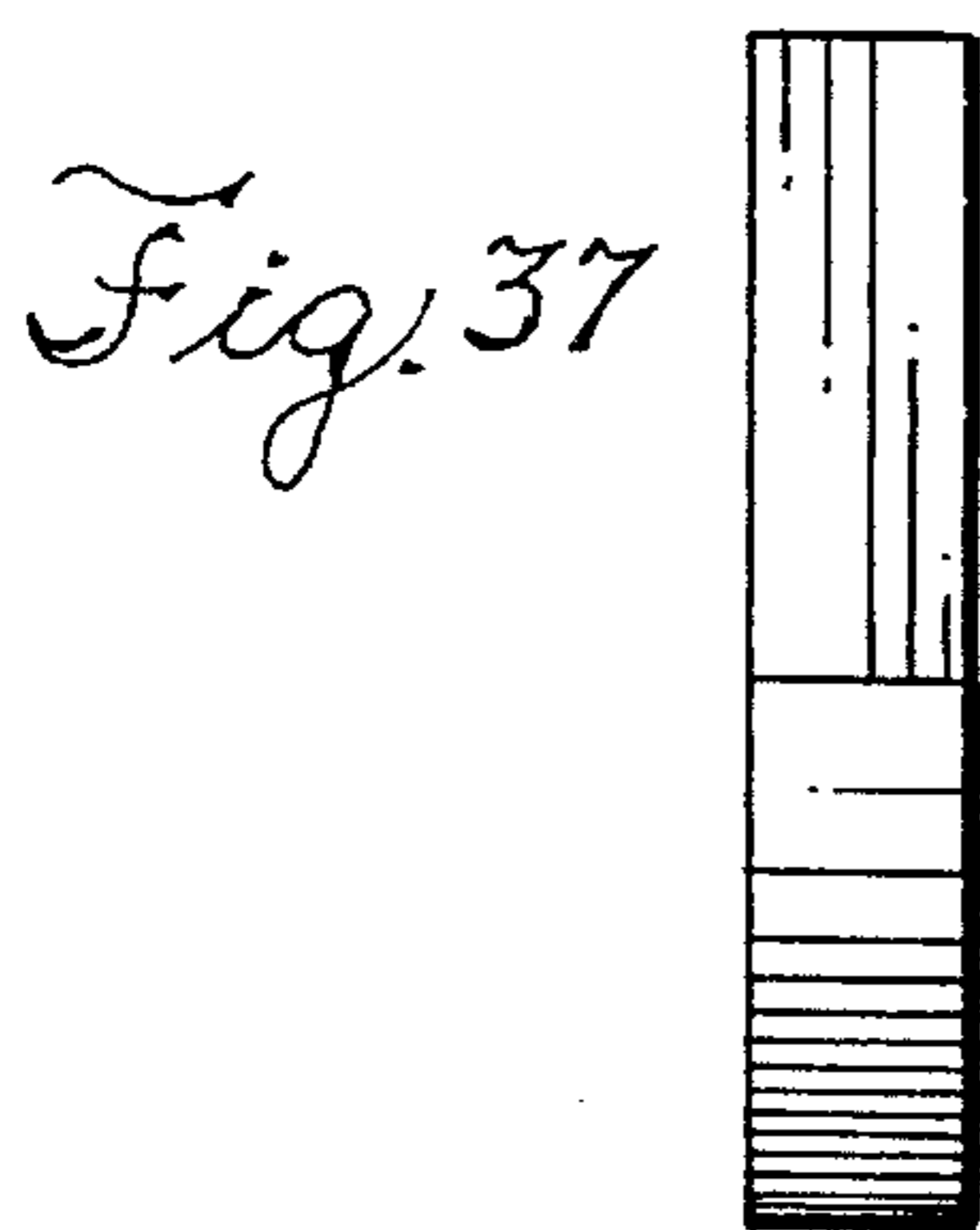
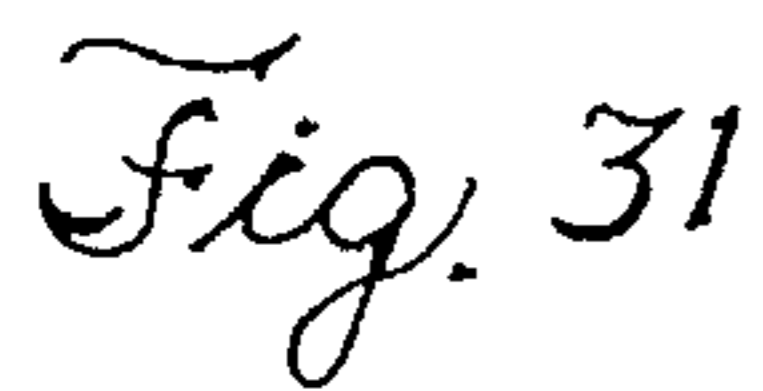
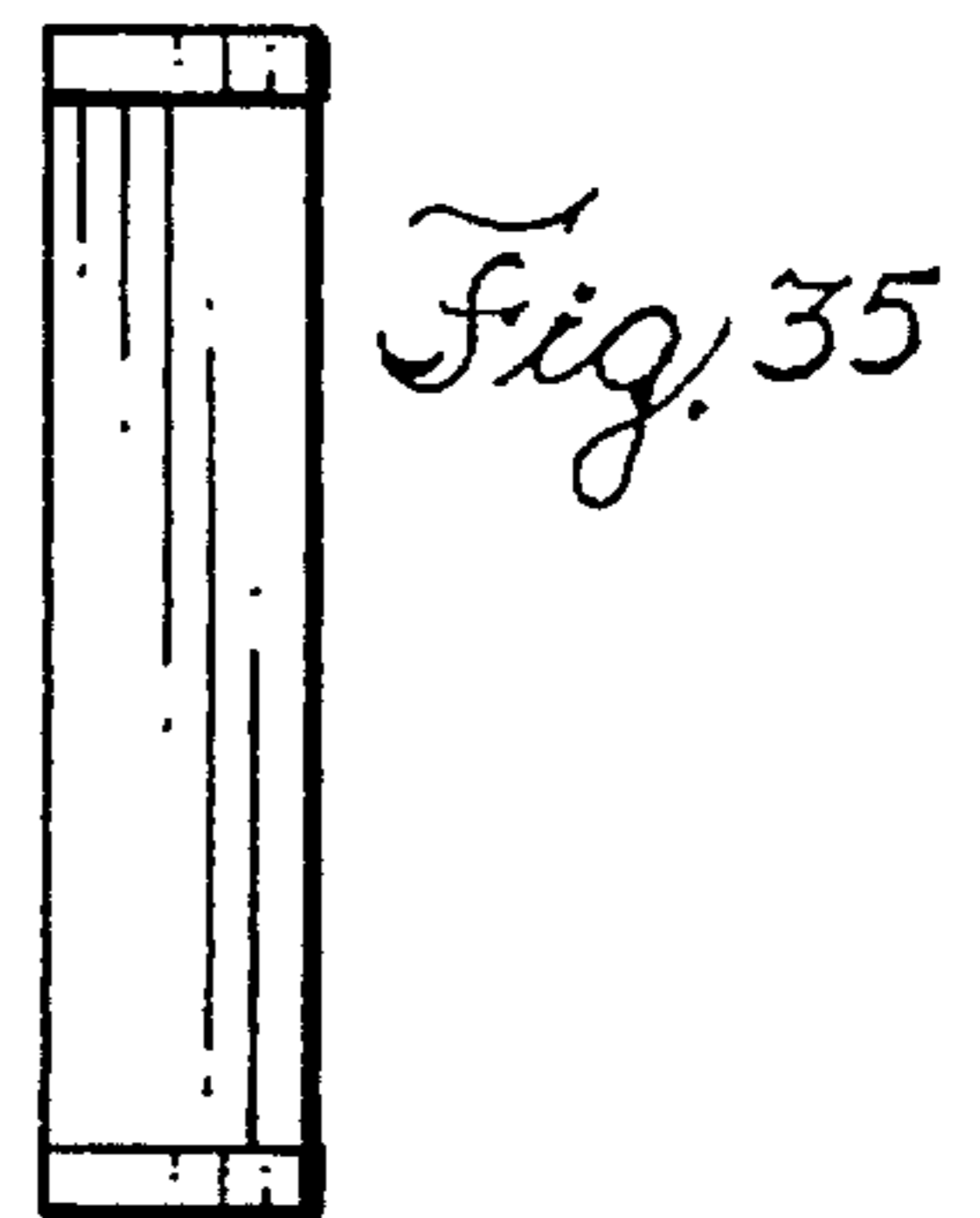
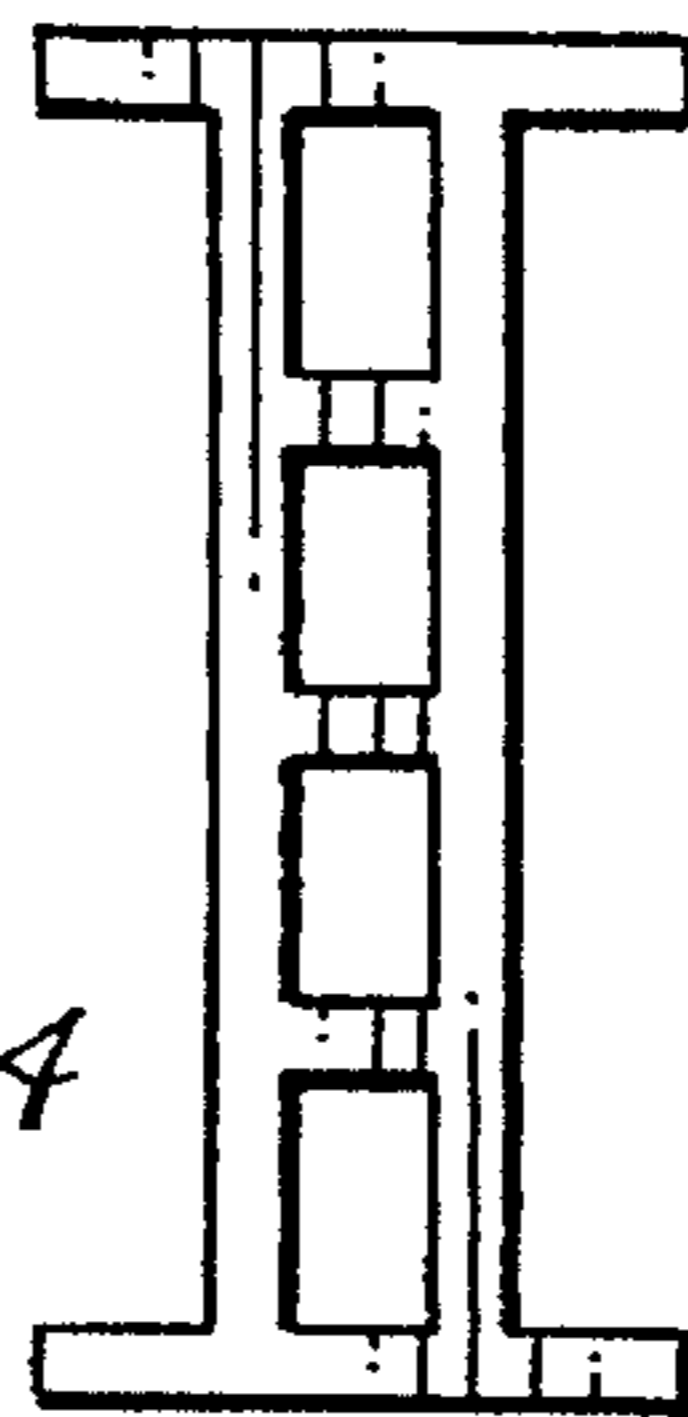
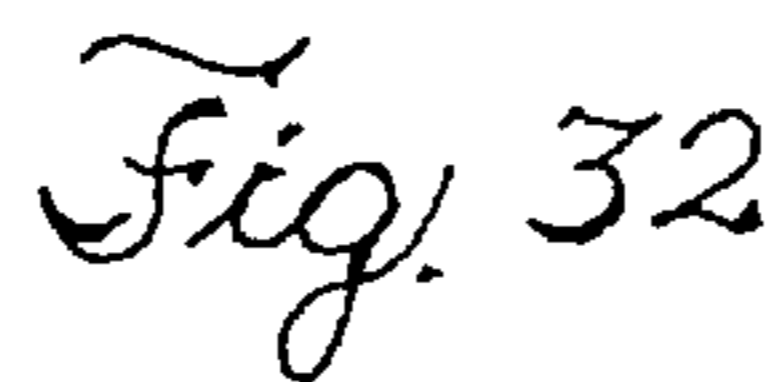
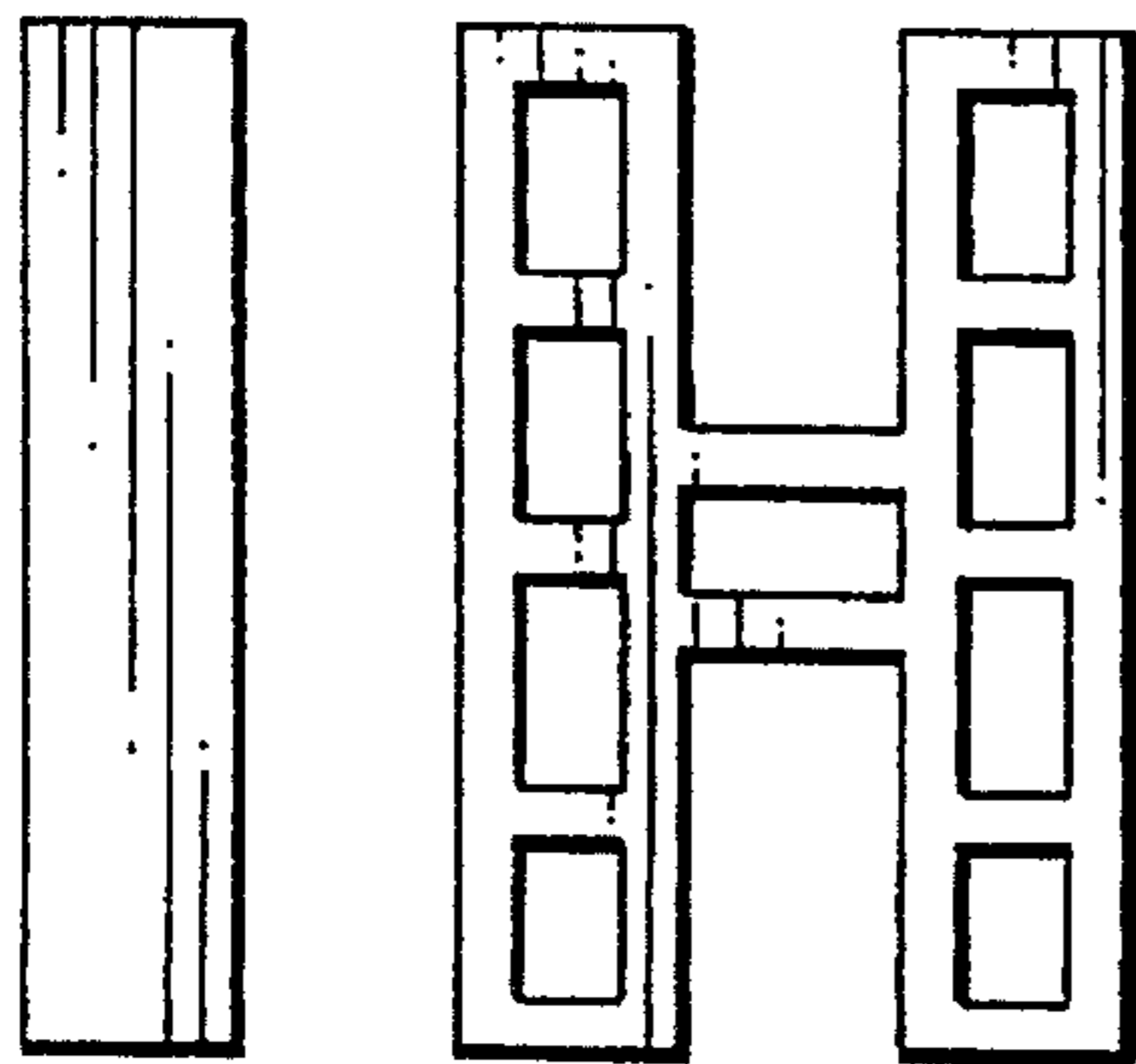
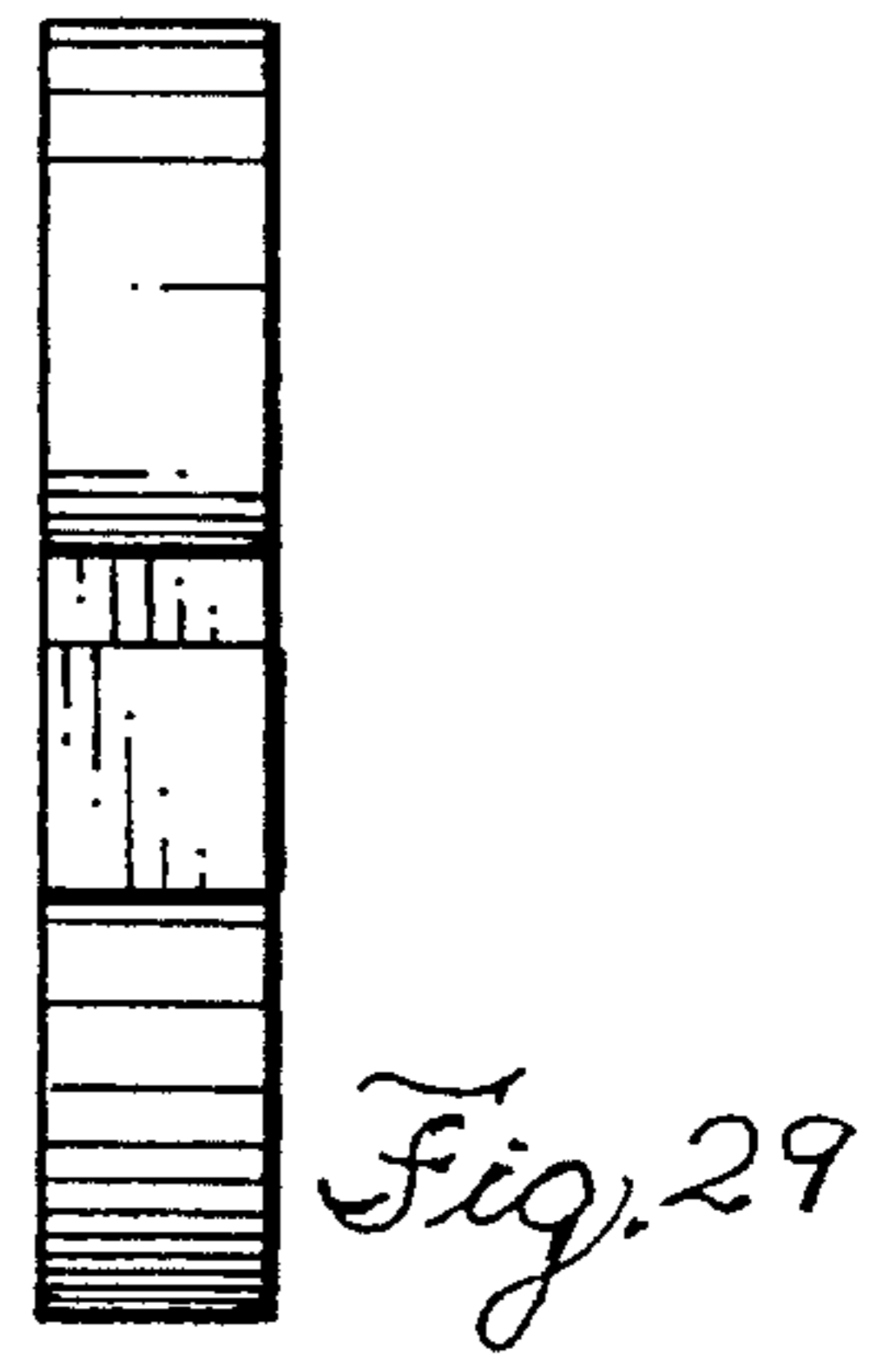
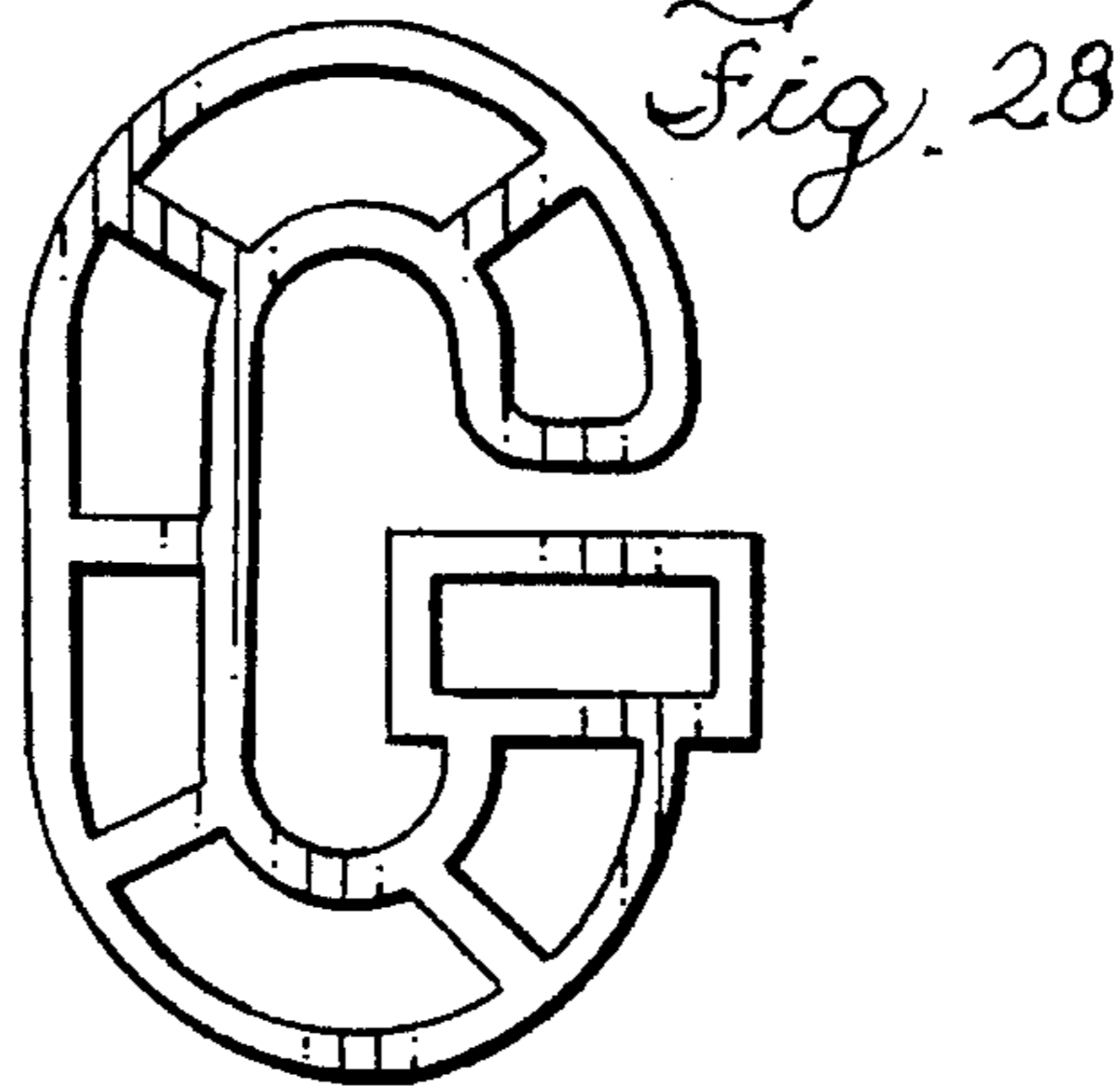
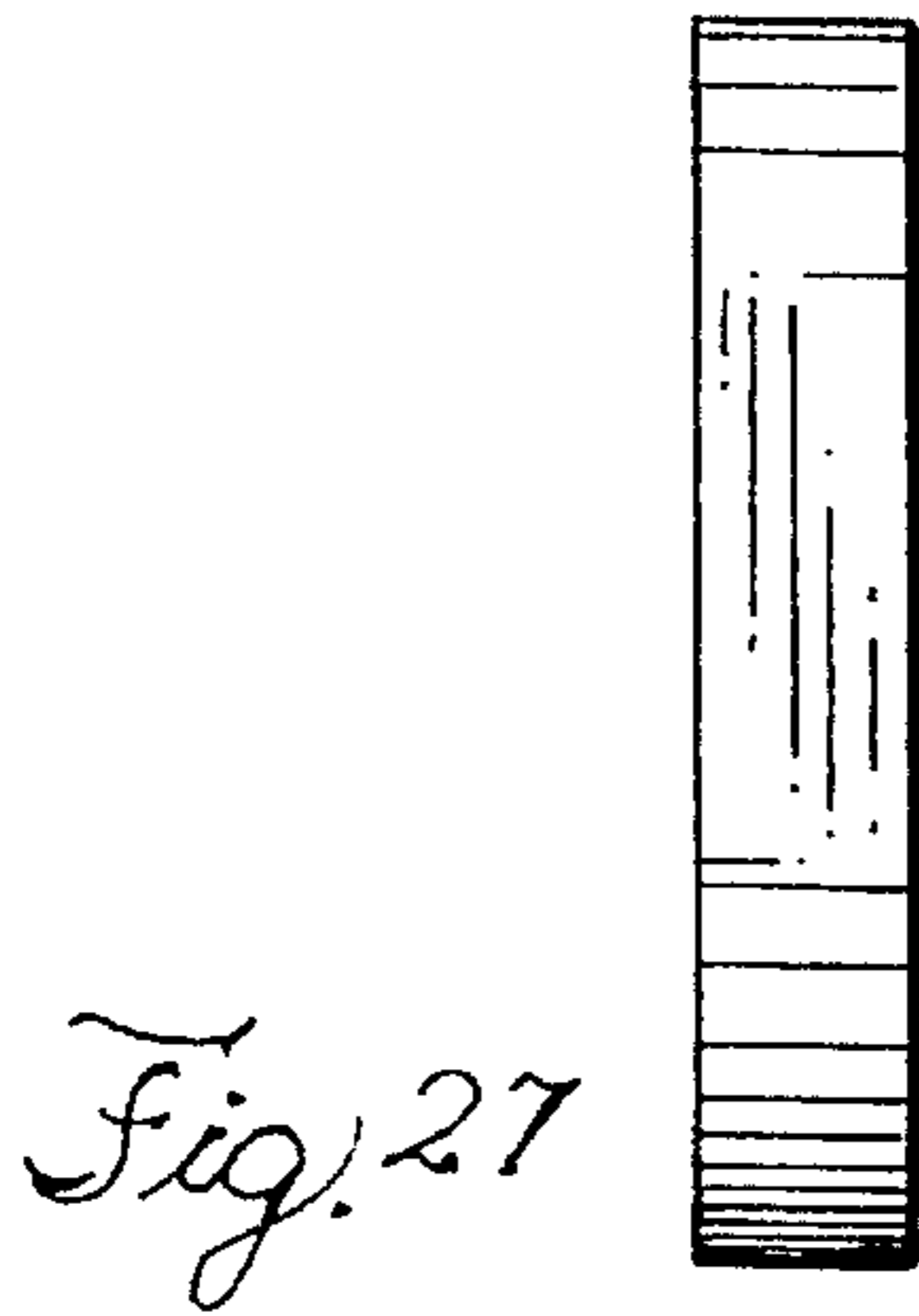
*Fig. 23*

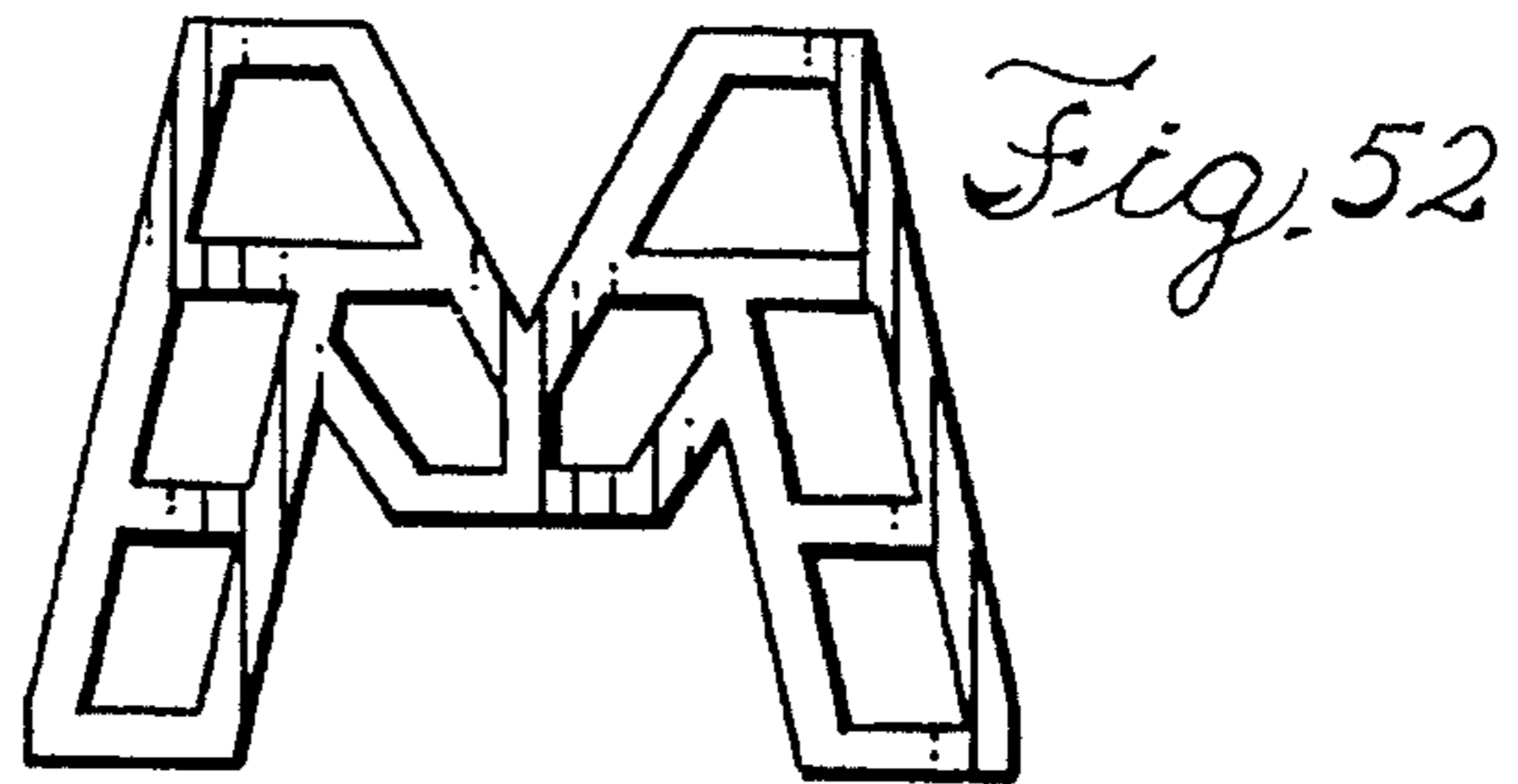
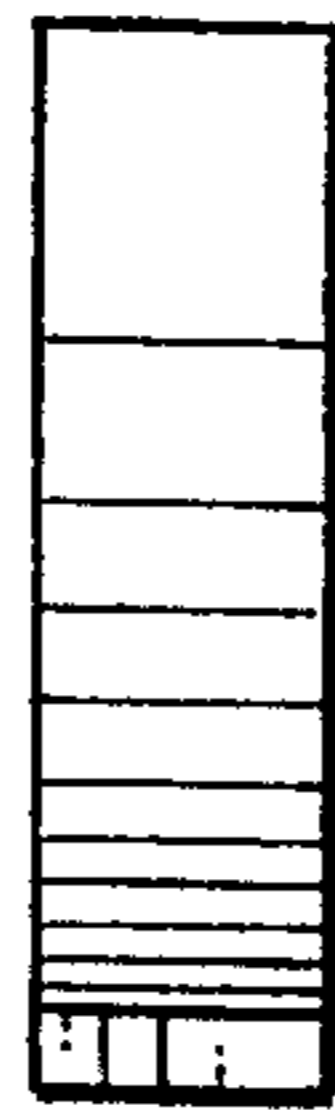
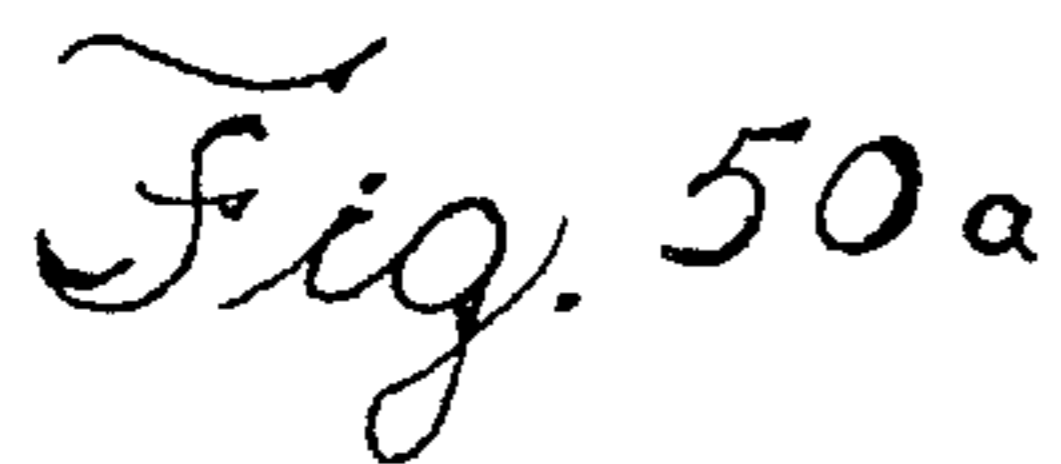
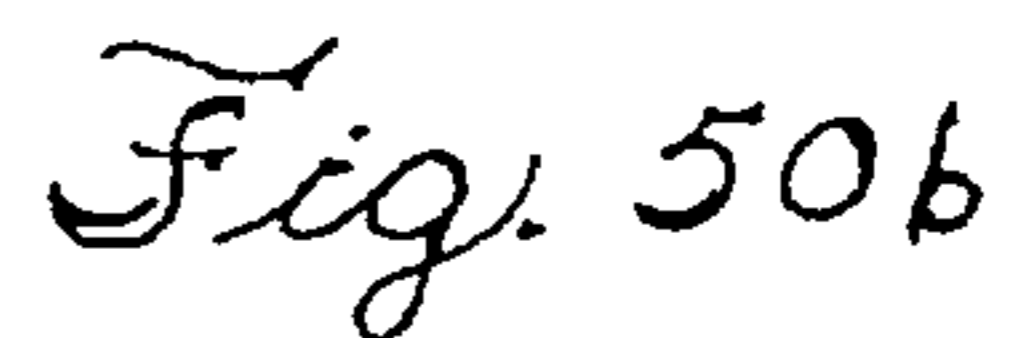
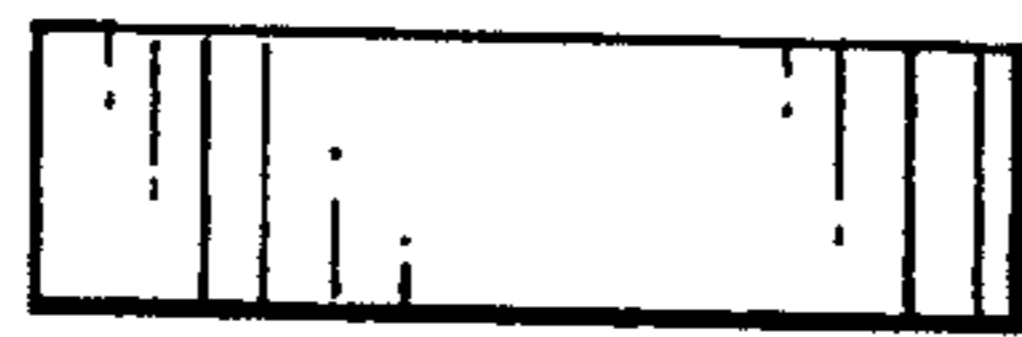
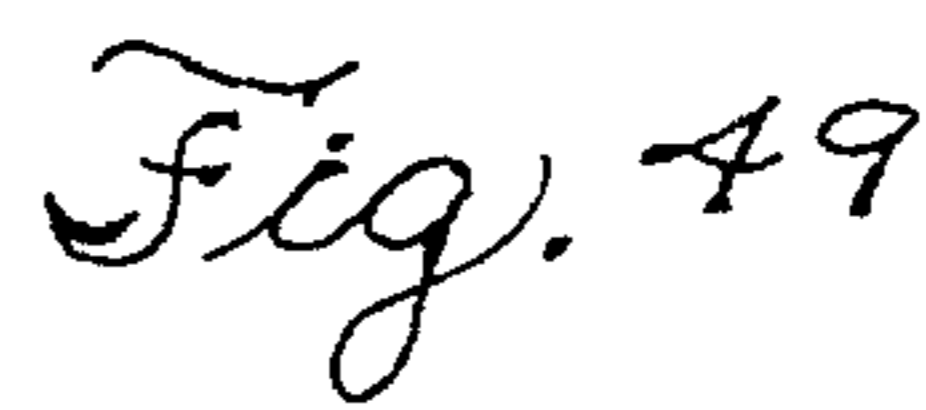
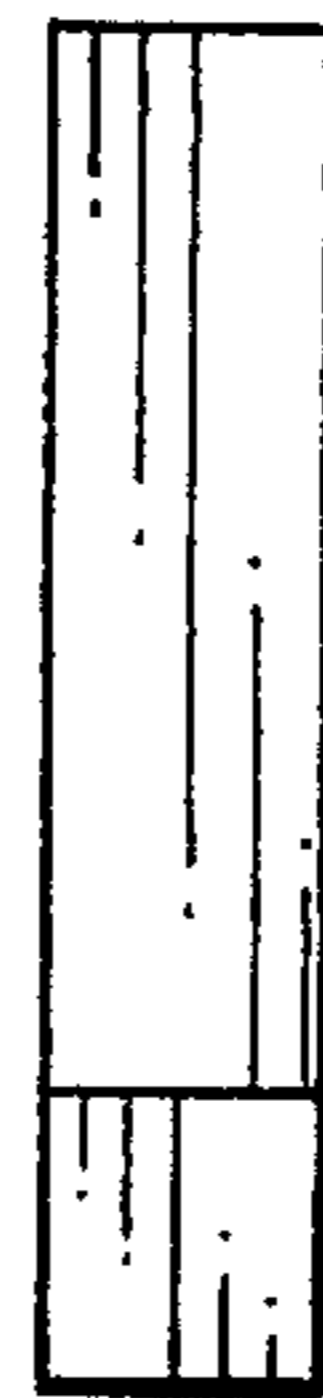
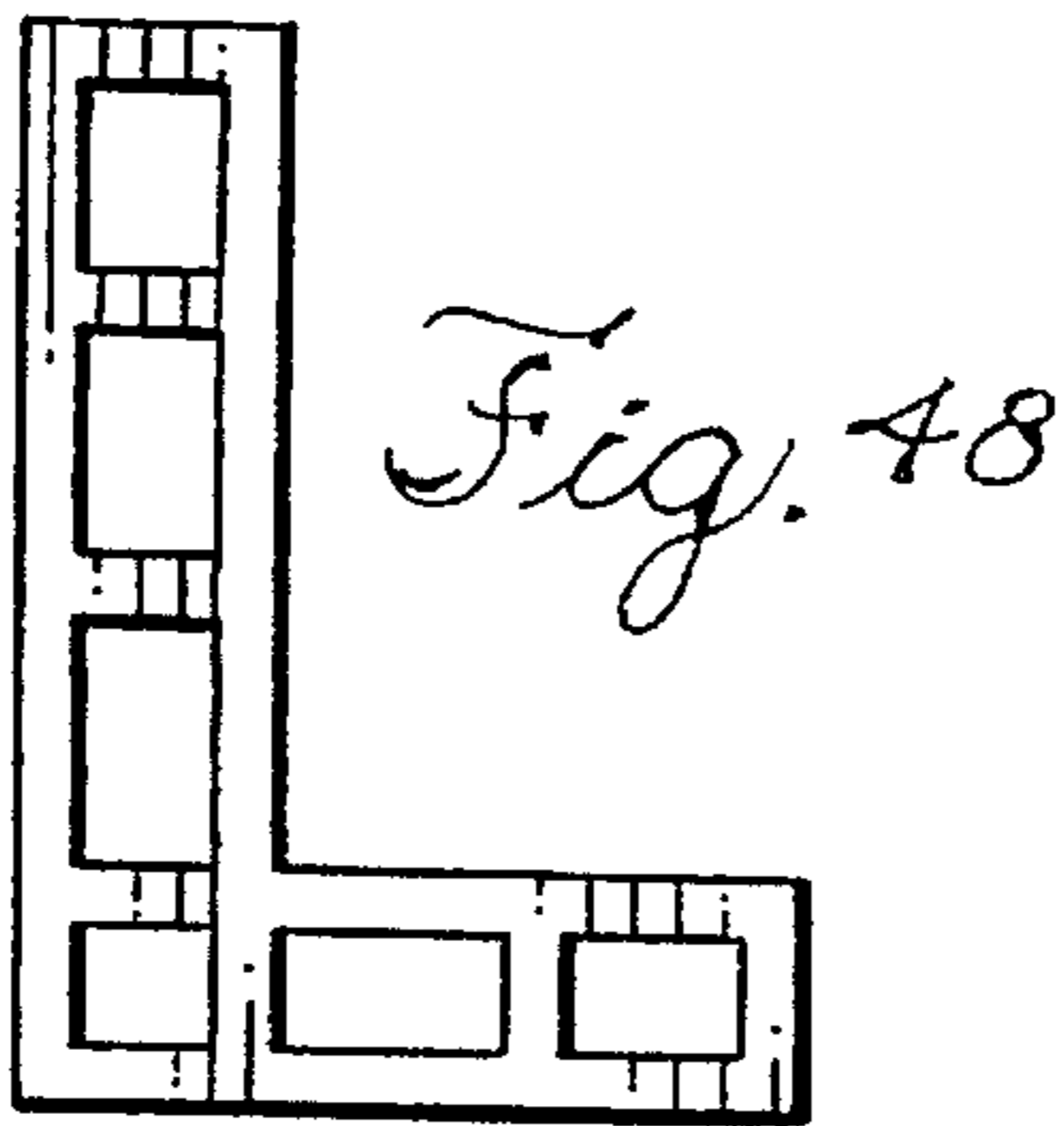
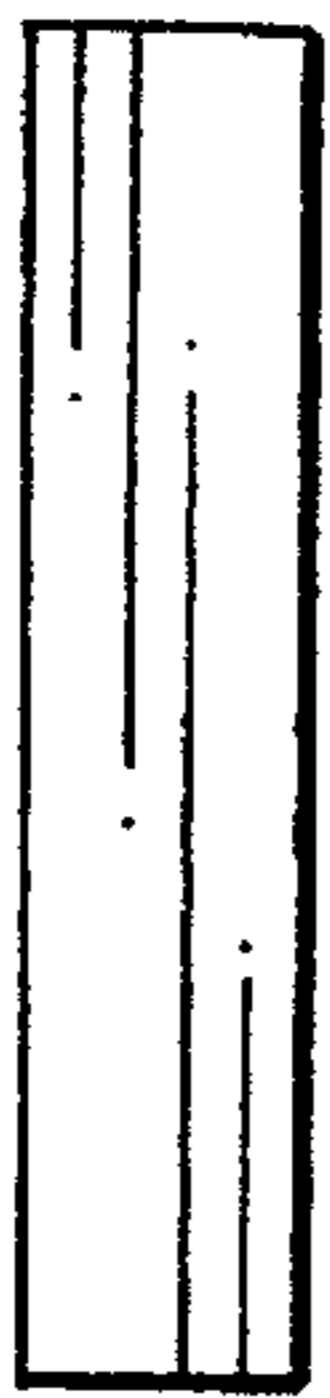
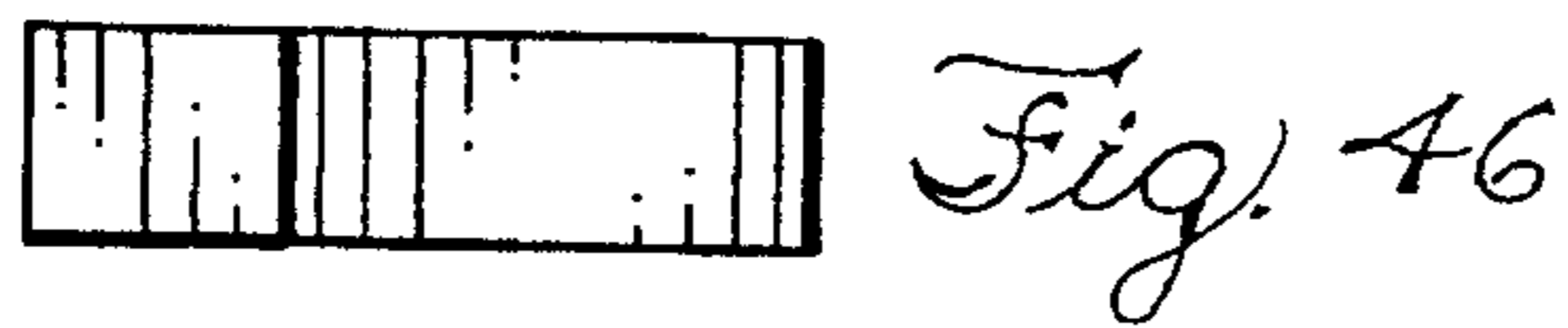
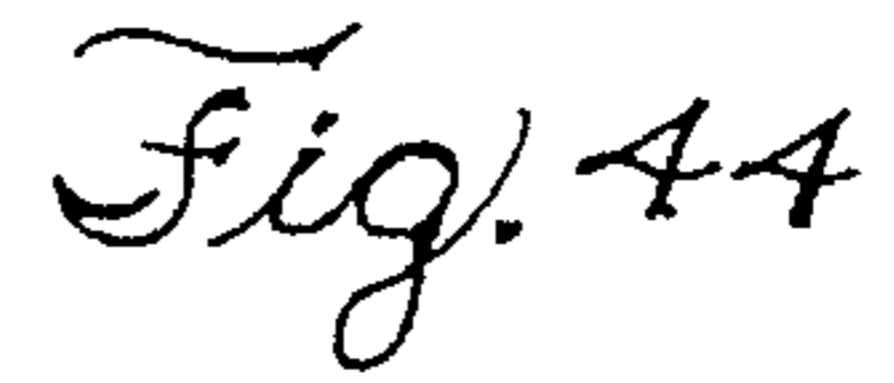
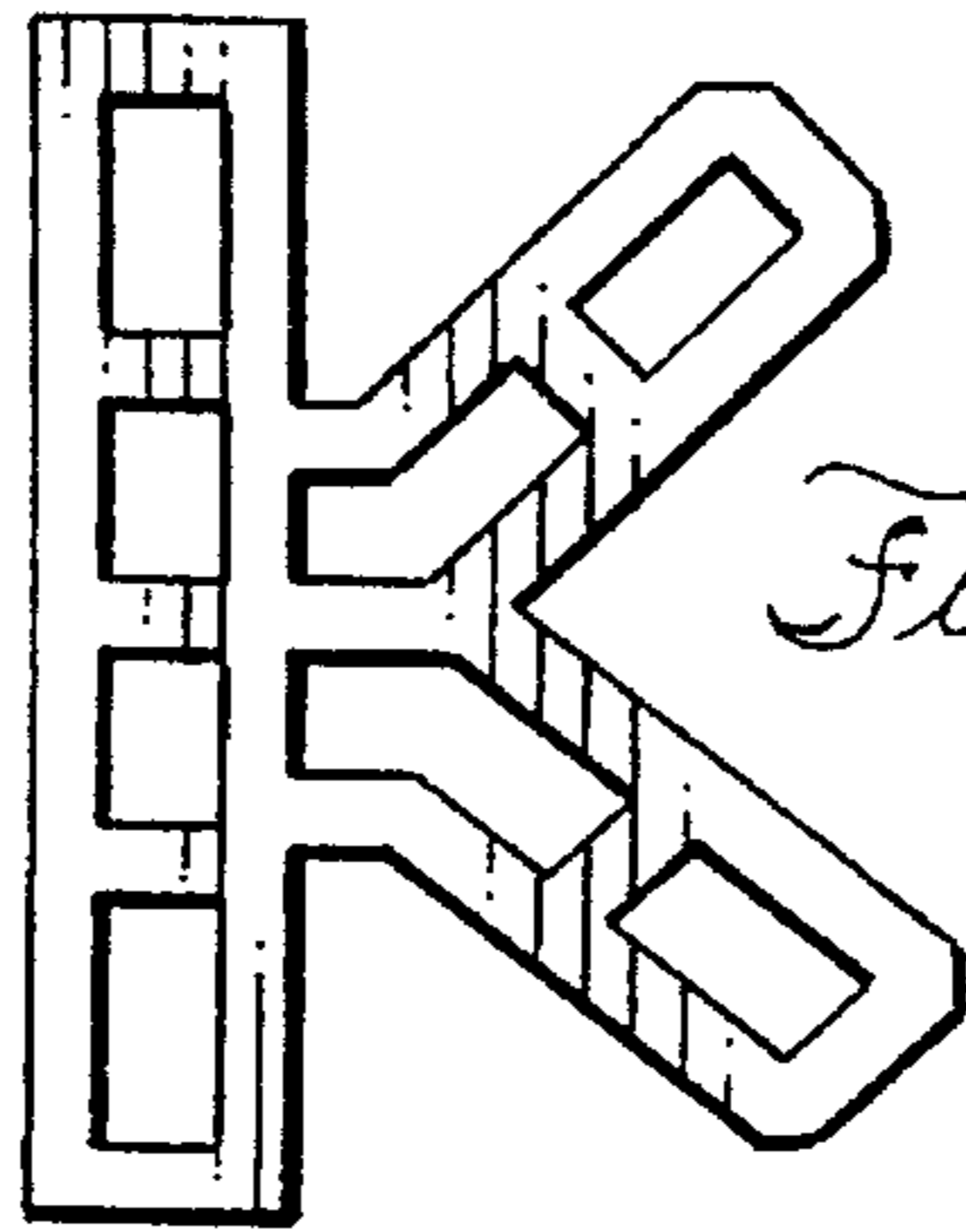
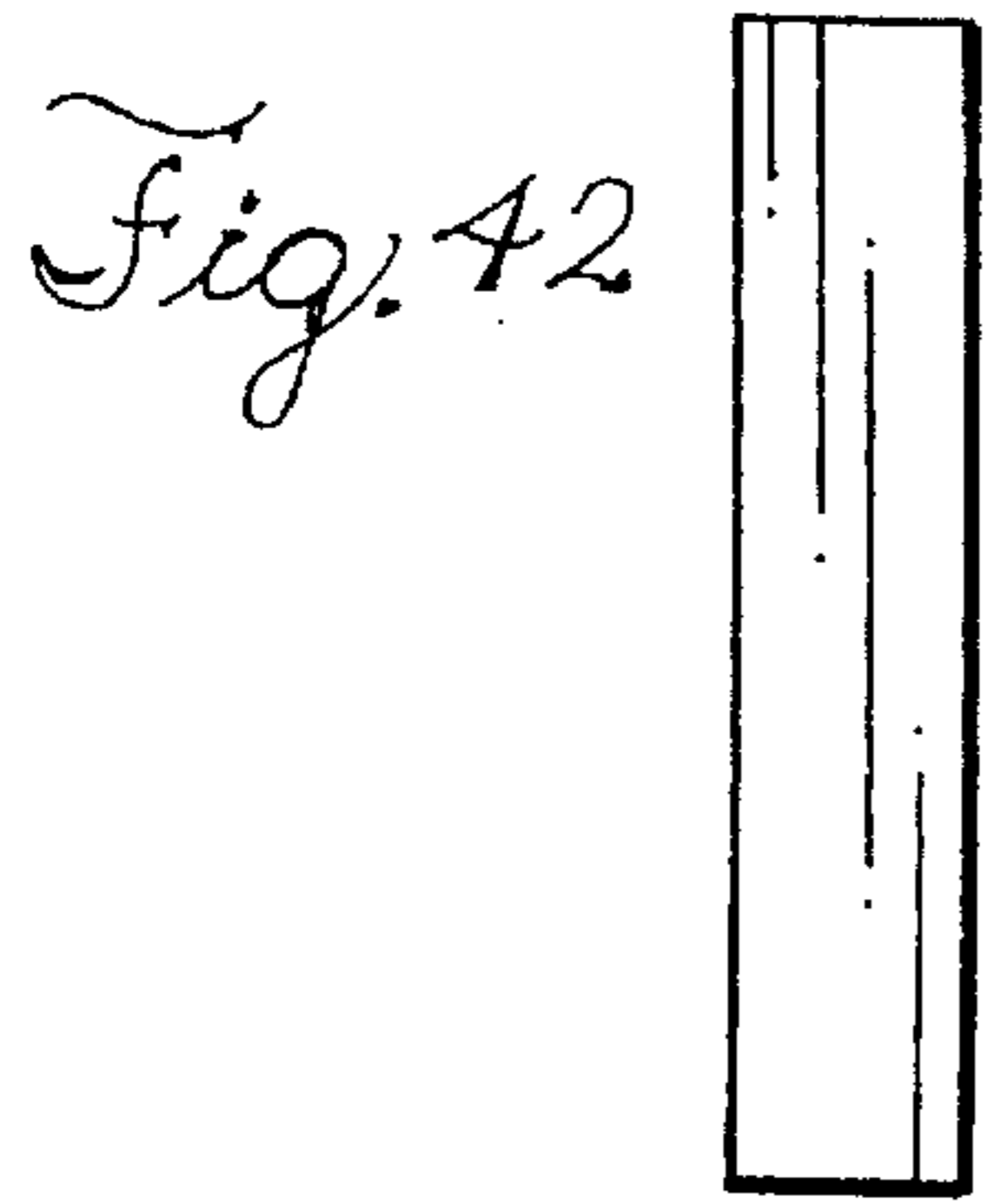


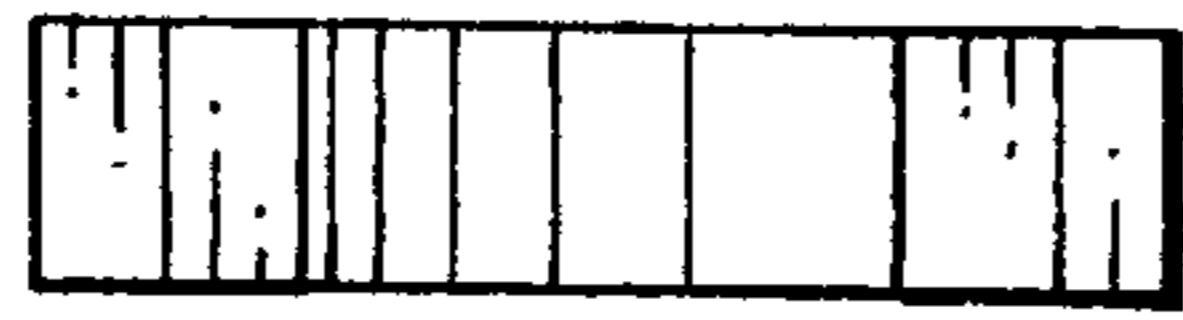
*Fig. 24*



*Fig. 25*

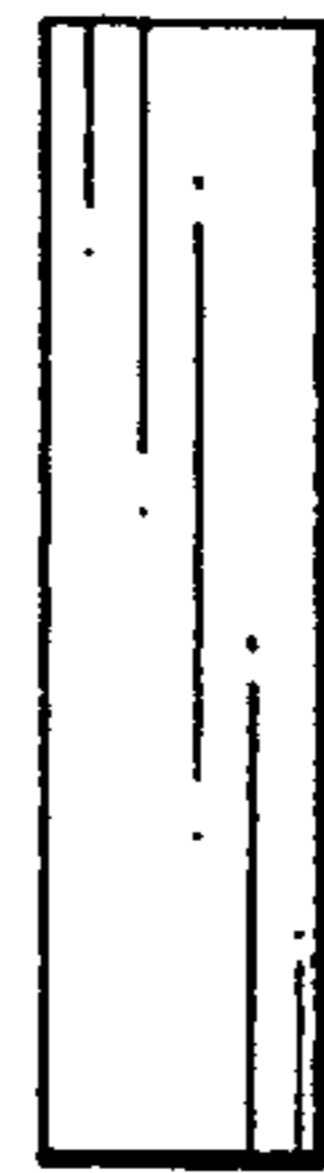
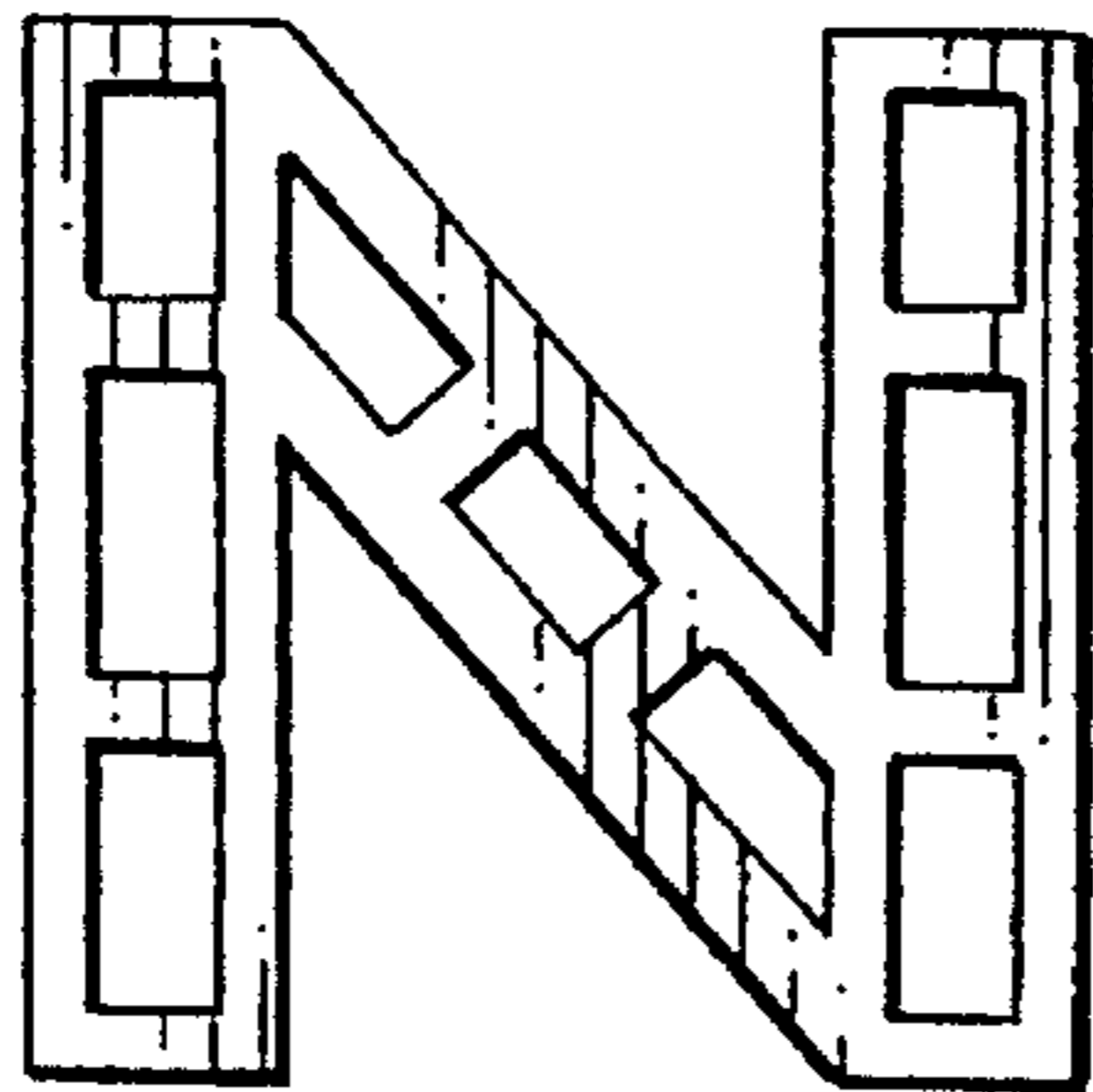






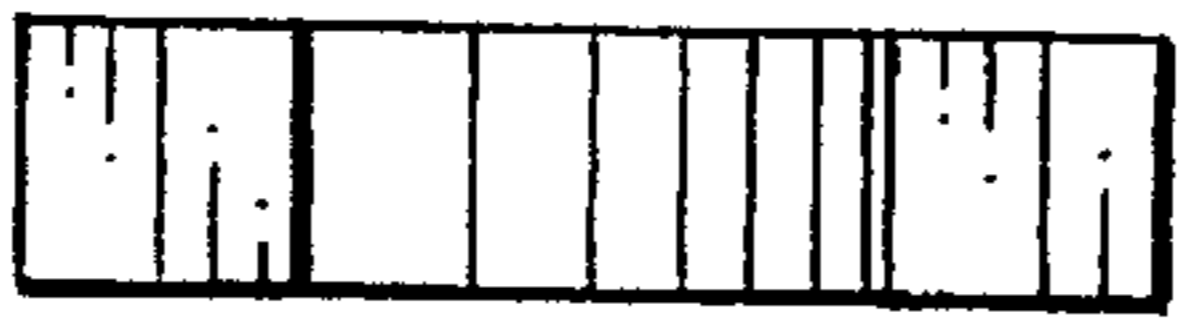
*Fig. 54*

*Fig. 55*



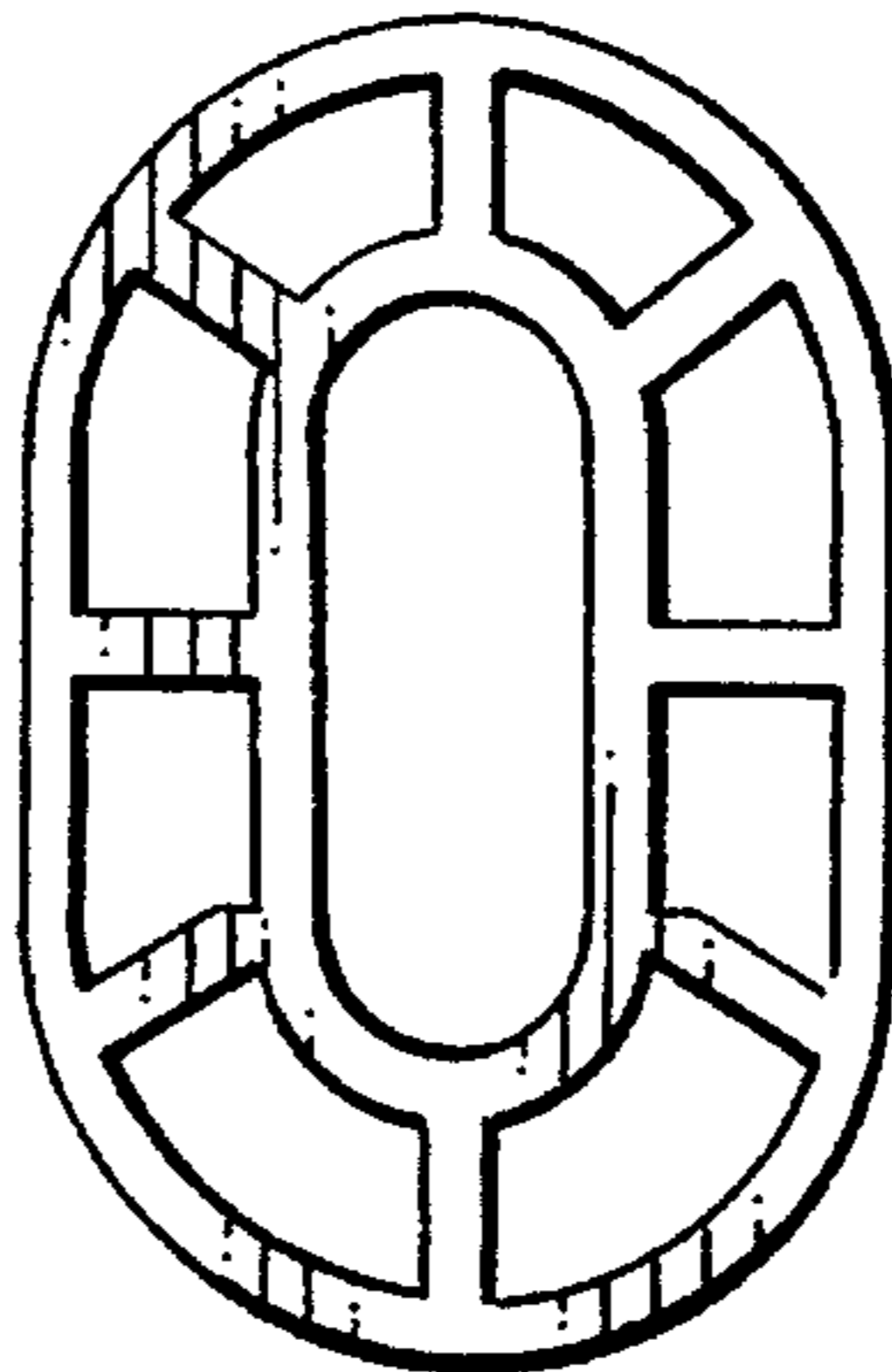
*Fig. 56*

*Fig. 57*



*Fig. 58*

*Fig. 59*

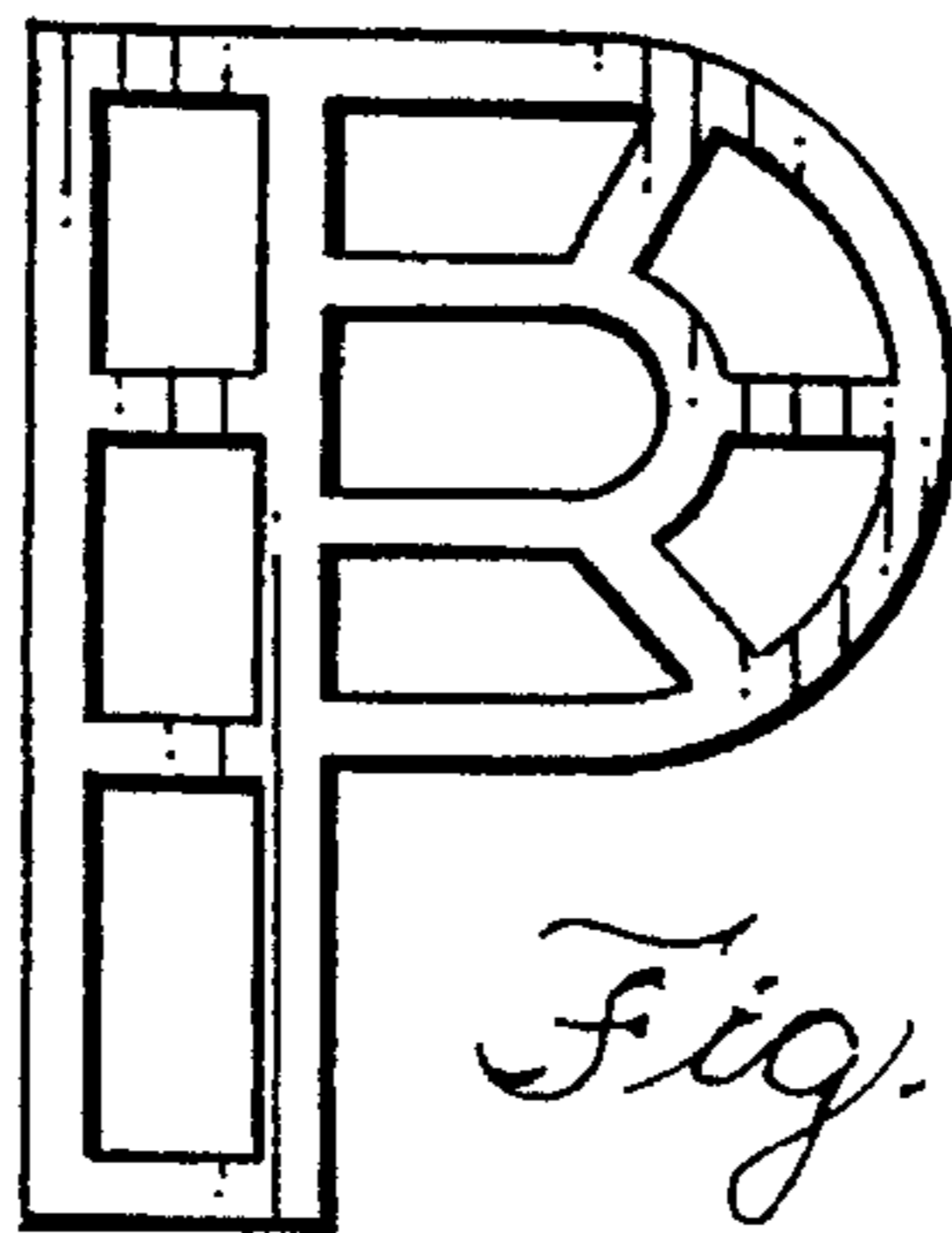
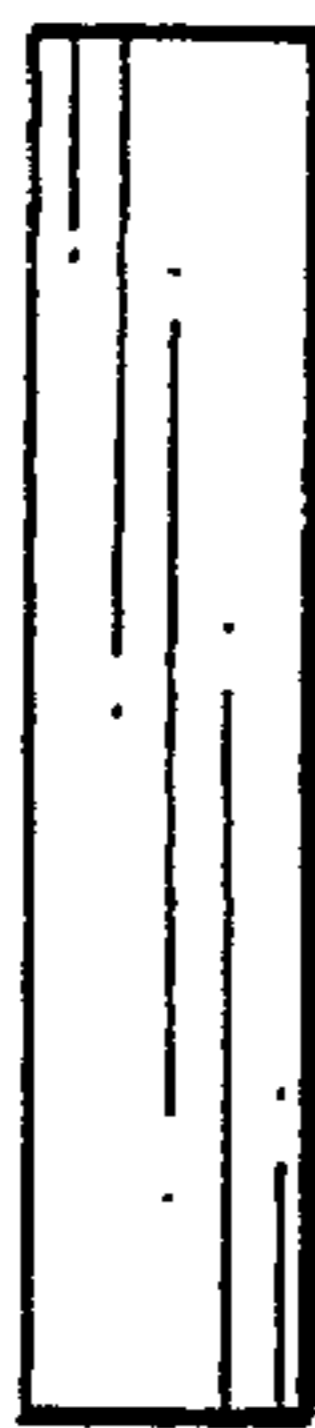


*Fig. 60*



*Fig. 61*

*Fig. 62*



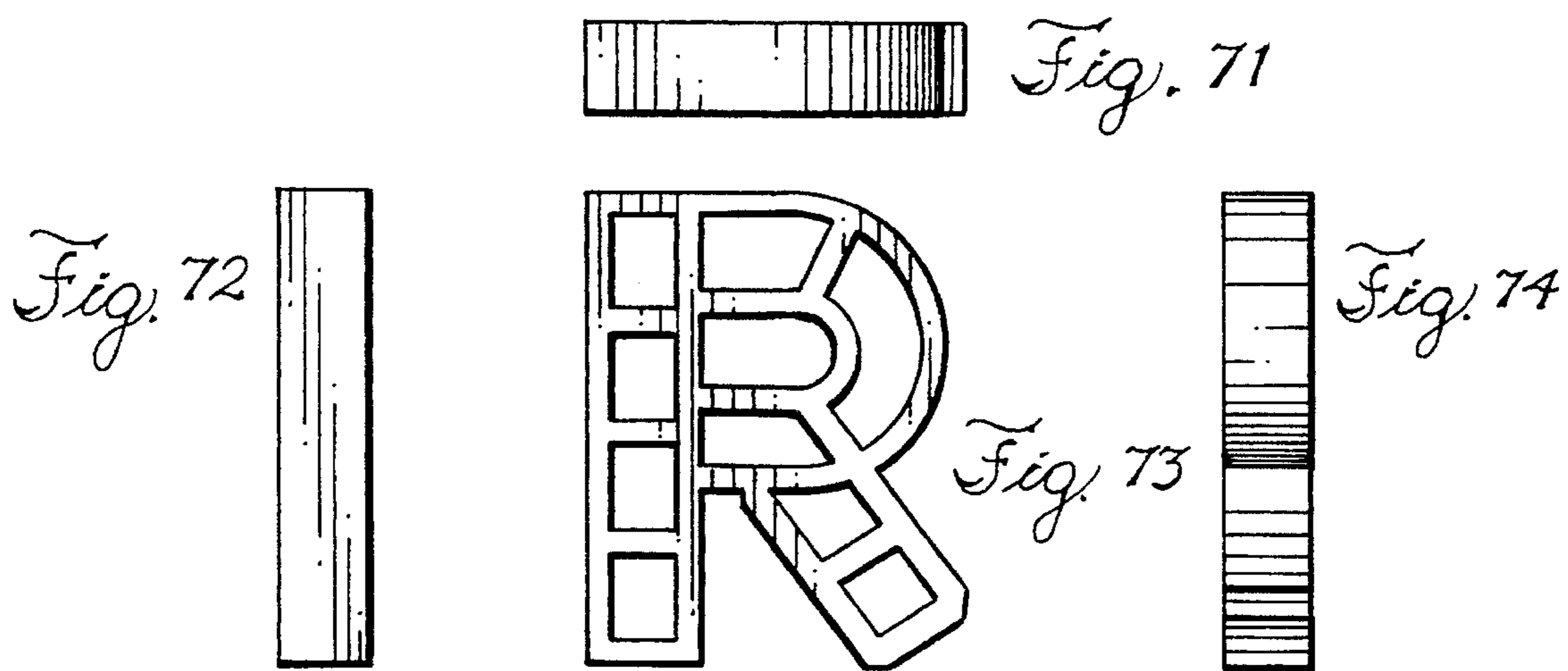
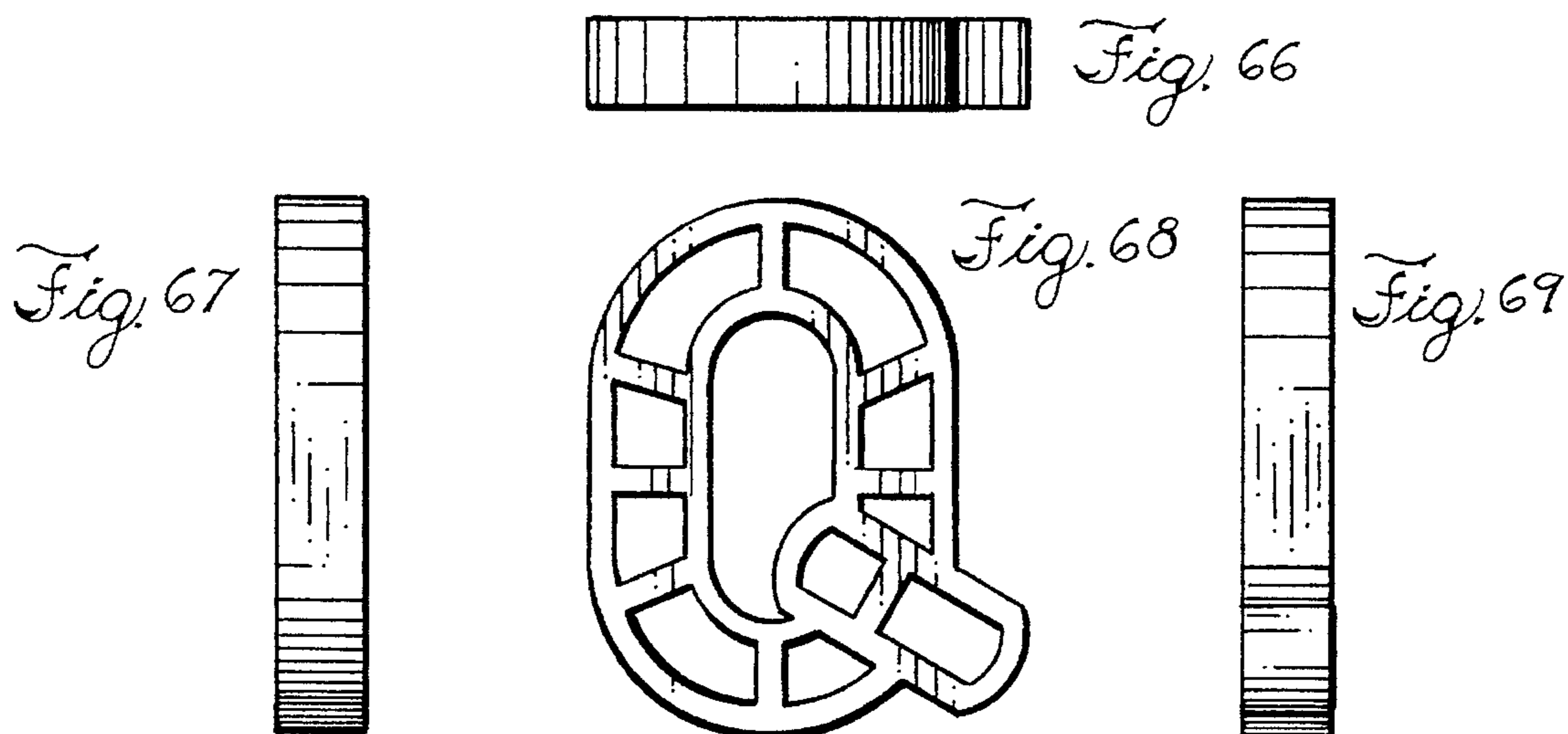
*Fig. 63*



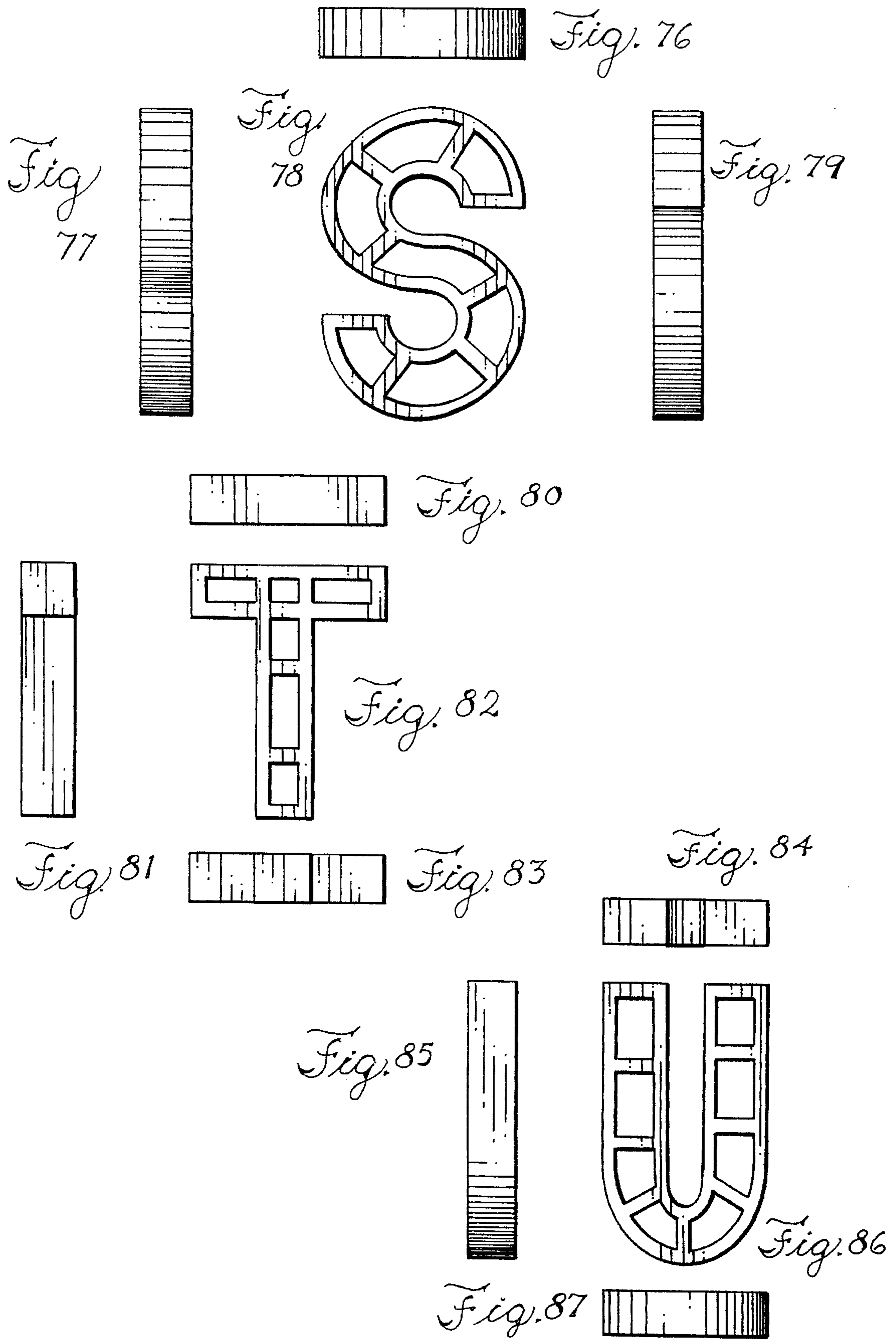
*Fig. 64*

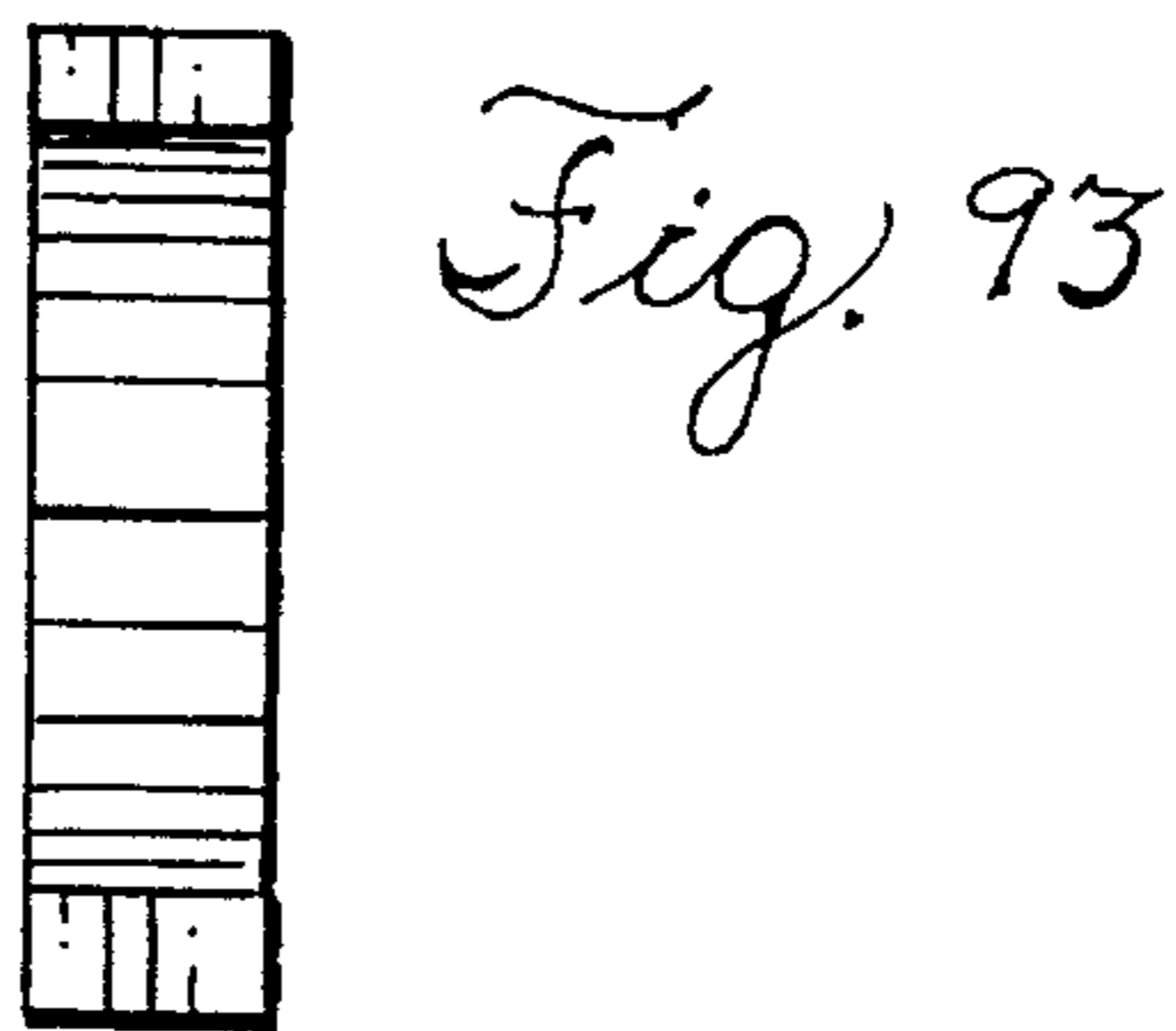
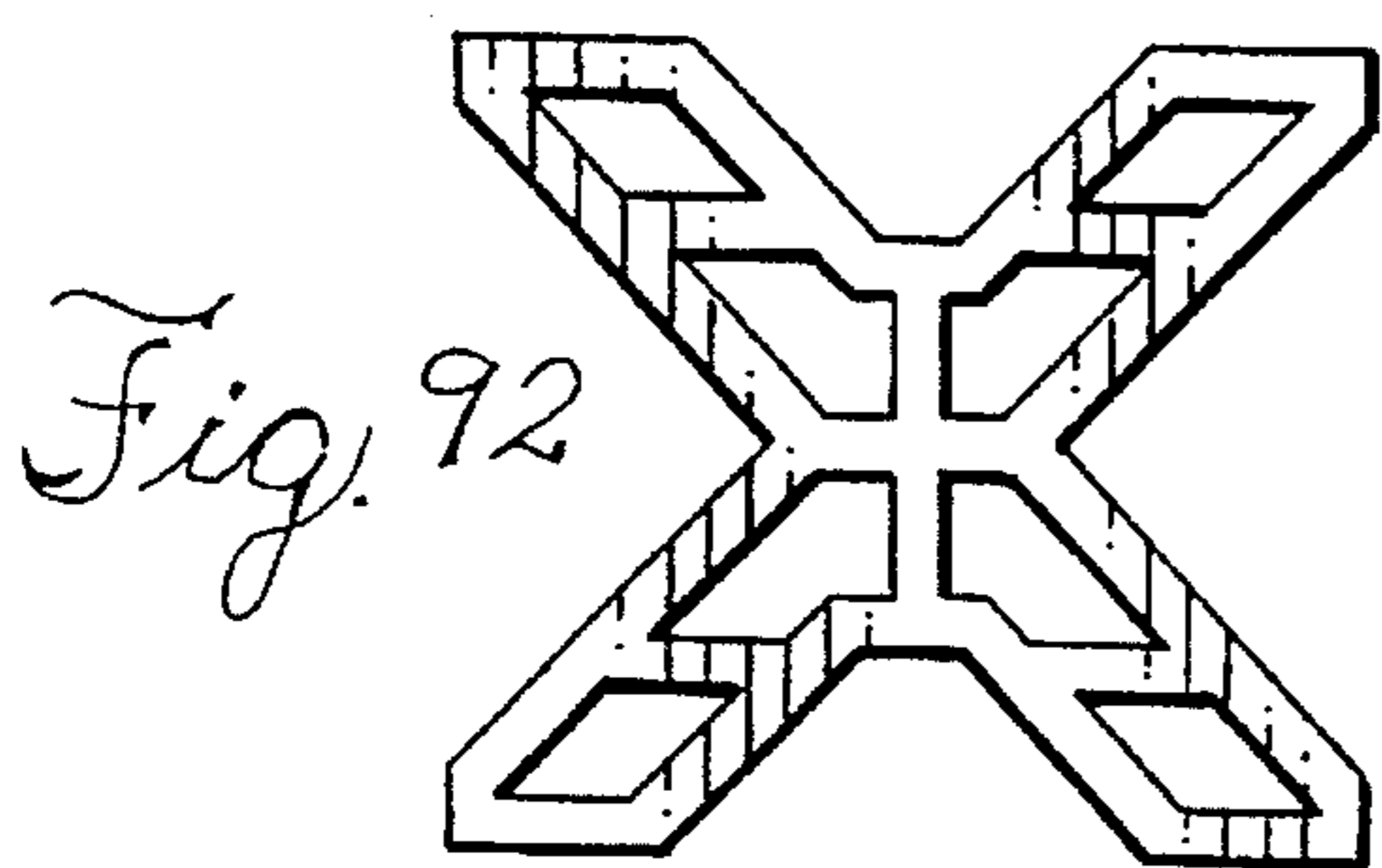
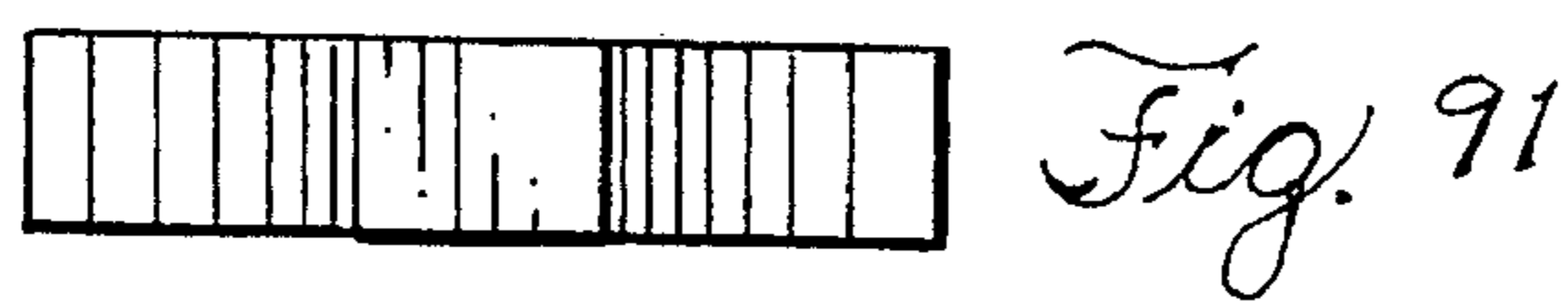
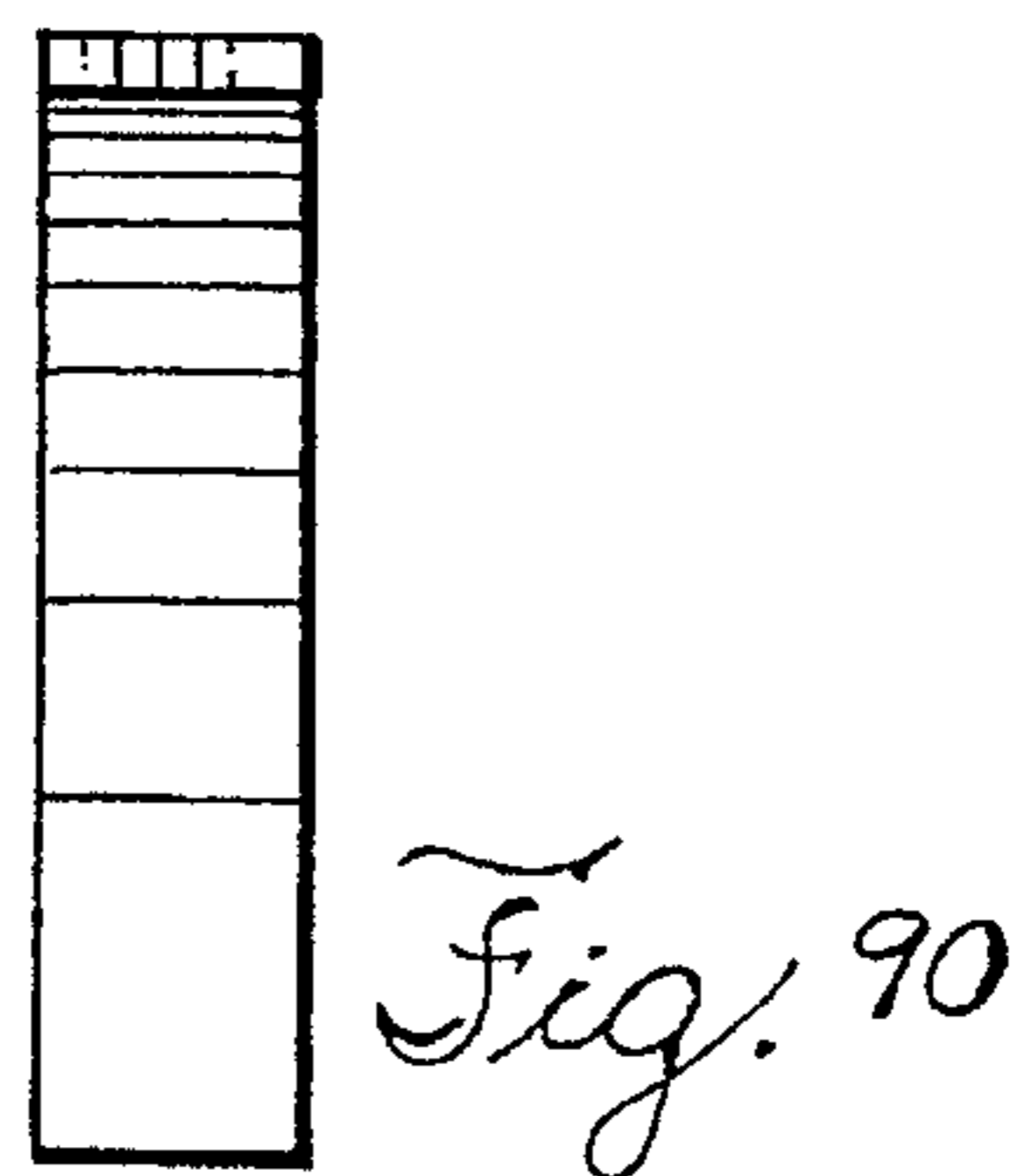
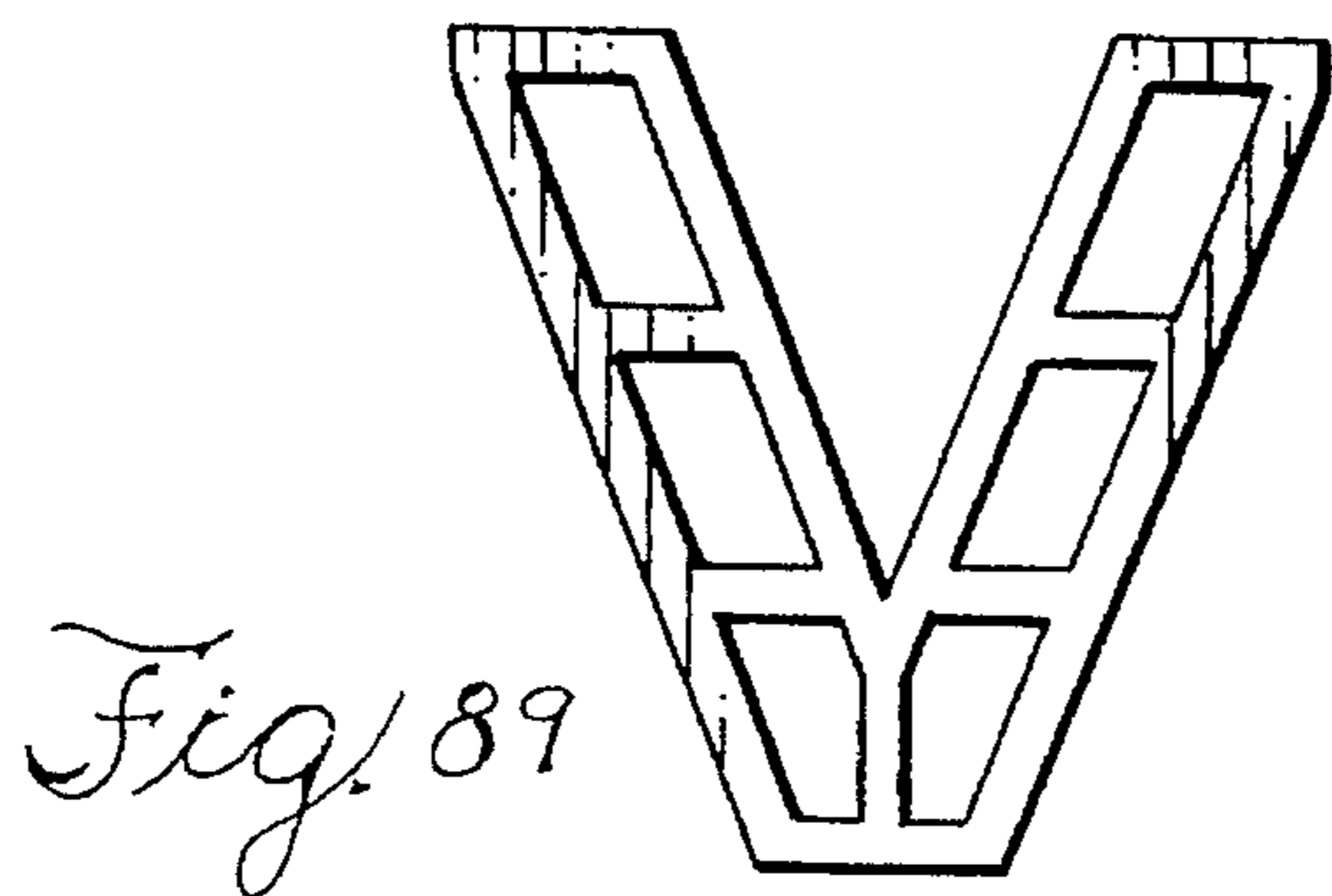
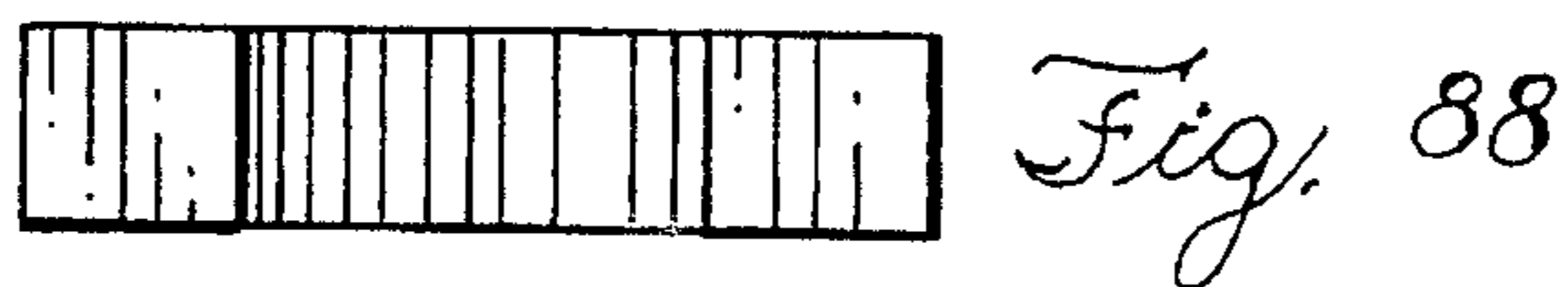
*Fig. 65*







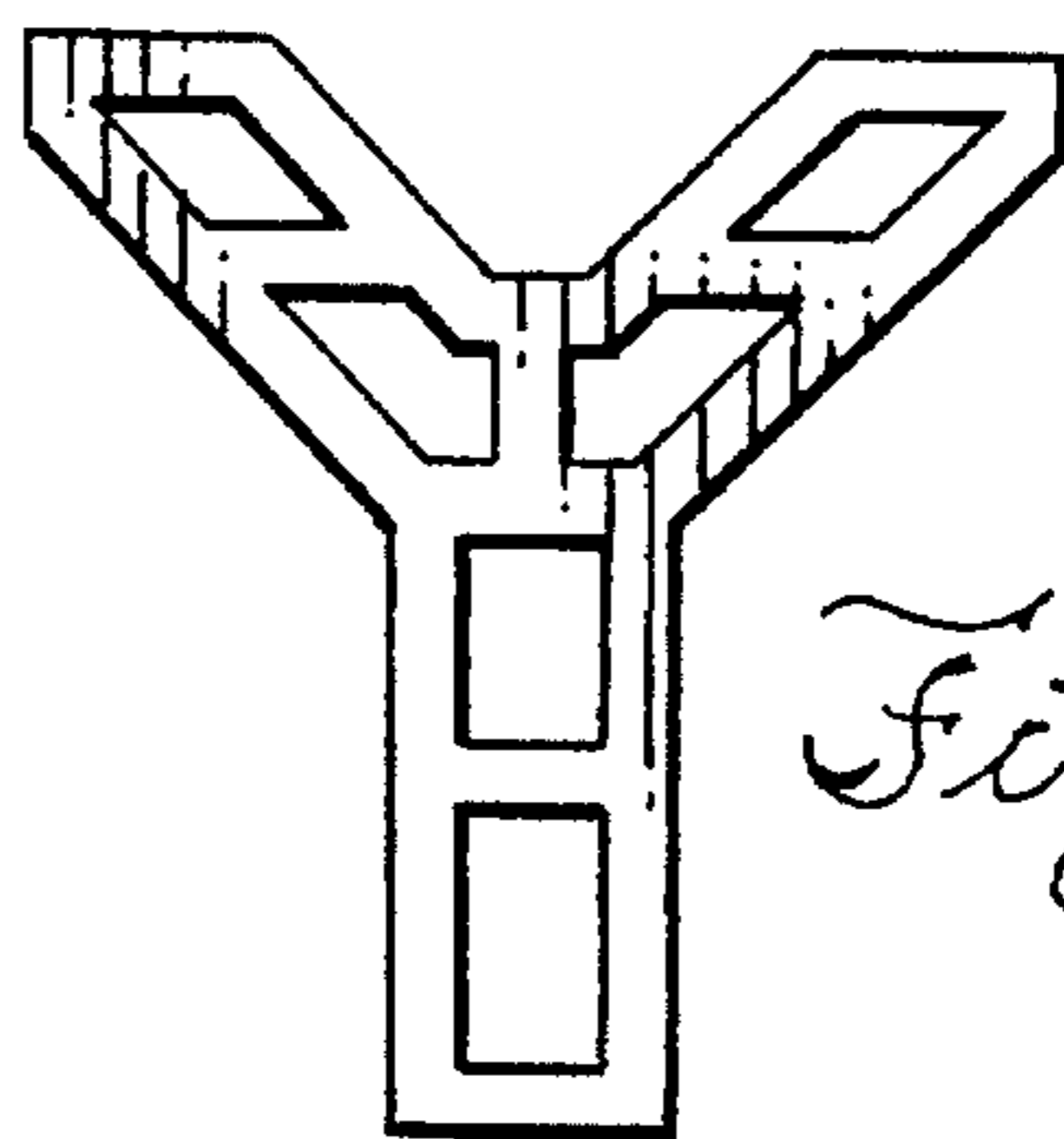




*Fig. 95*



*Fig. 96*



*Fig. 98*

