



US00D376452S

United States Patent [19]

Breen

[11] **Patent Number: Des. 376,452**

[45] **Date of Patent: **Dec. 10, 1996**

[54] **HANDLE PORTION OF A LAUNDRY BASKET**

[75] Inventor: **John D. Breen**, Wooster, Ohio

[73] Assignee: **Rubbermaid Incorporated**, Wooster, Ohio

[**] Term: **14 Years**

[21] Appl. No.: **45,766**

[22] Filed: **Oct. 30, 1995**

[52] **U.S. Cl.** **D32/37**

[58] **Field of Search** D32/37; D34/1, D34/10; 220/908-910, 768-770, 643, 318, 759; 232/1 R, 43.2; D3/304, 307

[56] **References Cited**

U.S. PATENT DOCUMENTS

D. 233,207	10/1974	Molzen	D7/163
D. 264,040	4/1982	Kunze	D32/37
D. 302,069	7/1989	Yoshikawa	D34/40
D. 326,345	5/1992	Mandell et al.	D32/37
D. 327,560	6/1992	Hradisky	D34/42
D. 343,711	1/1994	Craft et al.	D32/37
D. 344,378	2/1994	Wolff	D32/37
D. 344,823	3/1994	Wilgus et al.	D32/37
D. 348,128	6/1994	Craft et al.	D32/37
D. 350,423	9/1994	Craft et al.	D32/37
D. 351,266	10/1994	Licari	D32/37
D. 362,931	10/1995	Brightbill et al.	D32/37
D. 362,933	10/1995	Calmeise	D32/37
1,992,378	2/1935	Lewis	220/770
3,341,060	9/1967	Rehrig et al.	220/770
4,946,059	8/1990	Rehrig	220/643
4,981,232	1/1991	Wynn	220/22.3
5,133,472	7/1992	Koda et al.	220/94
5,145,082	9/1992	Craft et al.	220/755
5,279,443	1/1994	Koda et al.	220/769
5,287,991	2/1994	Koda et al.	220/769

FOREIGN PATENT DOCUMENTS

4018881 7/1989 Germany .

OTHER PUBLICATIONS

Catalog page, Laundry basket; Sterilite Corporation, P.O. Box 524, Townsend, Massachusetts 01469-524. Publication date 1993.

P. 7, Laundry basket; Sterilite Corporation, P.O. Box 524, Townsend, Massachusetts 01469-524. Publication date 1993.

Sell sheet, Laundry baskets; Mobil Chemical Company, 150 East 42nd Street, New York 10017-5666. Publication date 1991.

Catalog page, Laundry baskets; Tucker Housewares, 25 Tucker Drive, Leominster, Massachusetts 01469. Publication date 1992.

P. 3, Laundry baskets; Ingrid Housewares, 360 North Skokie Highway, North Chicago, Illinois 60064. Publication date Jan., 1990.

Sell sheet, Laundry baskets; Frem Corporation, 60 Webster Place, Worcester, Massachusetts 01603-0004. Publication date 1991.

P. 3, Laundry baskets; Rubbermaid, Takkebijsters 75, 4817 BL Breda, Postbus 6810, 4802 HV Breda, Netherlands. Publication date 1991.

P. 15, Laundry baskets; Curver, Takkebijsters 75, 4817 BL Breda, Postbus 6810, 4802 HV Breda, Netherlands. Publication date 1991.

P. 2, Laundry baskets; Dupol-Rubbermaid GmbH, An der Trift 63, D06072 Dreieich, West Germany. Publication date 1989.

P. 26, Laundry baskets; Rubbermaid Incorporated, 1147 Akron Road, Wooster, Ohio 44691. Publication date 1990.

Primary Examiner—A. Hugo Word

Assistant Examiner—Robin V. Taylor

Attorney, Agent, or Firm—Richard B. O'Planick; Lisa B. Riedesel

[57] **CLAIM**

The ornamental design for a handle portion of a laundry basket, as shown and described.

DESCRIPTION

FIG. 1 is a top right front perspective view of a handle portion of a laundry basket showing my new design. The broken line showing of a laundry basket is for illustrative purposes only and forms no part of the claimed design;

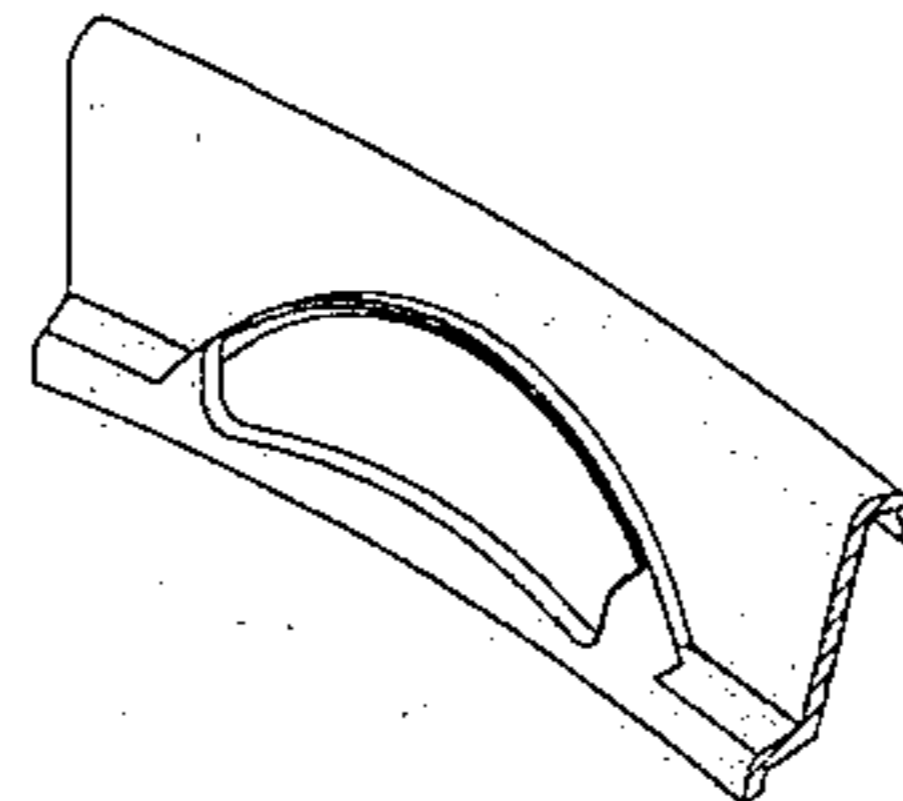

FIG. 2 is a front elevational view thereof;
FIG. 3 is a left side elevational view thereof; the right side
elevational view being a mirror image;
FIG. 4 is a rear elevational view thereof;

FIG. 5 is a top plan view thereof; and,
FIG. 6 is a bottom plan view thereof.

1 Claim, 3 Drawing Sheets

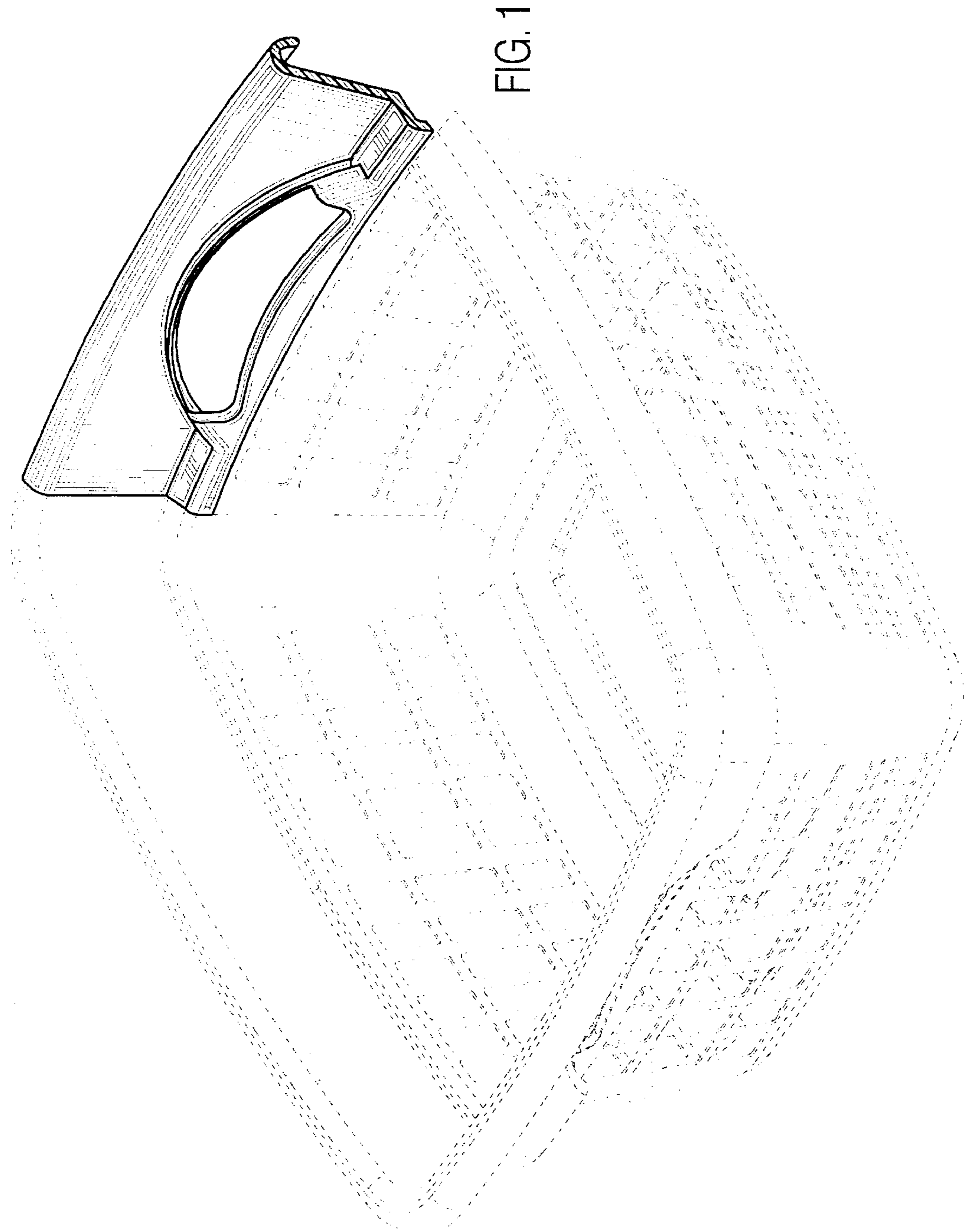

FIG. 1

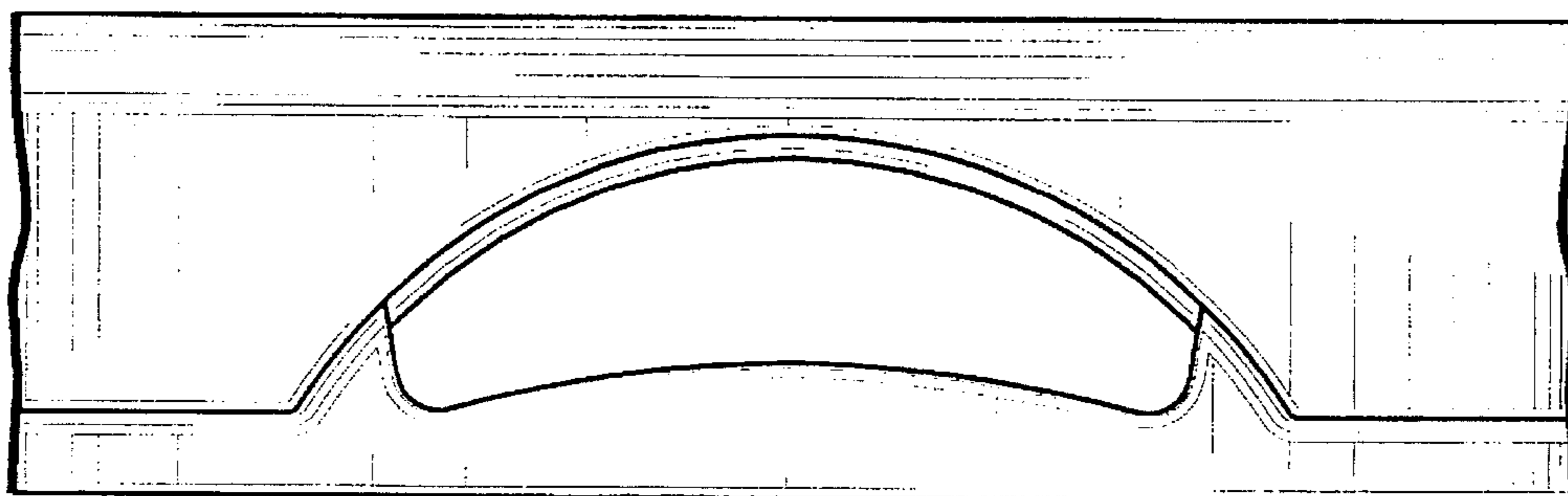

FIG. 2

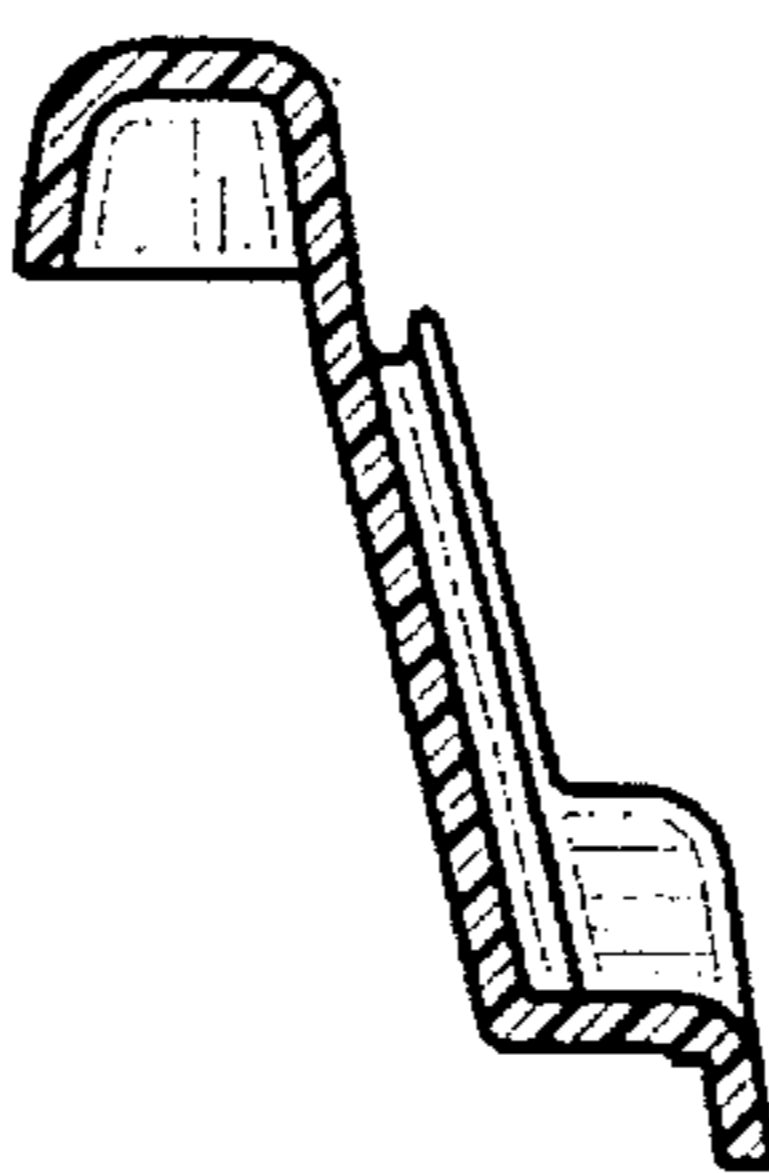

FIG. 3

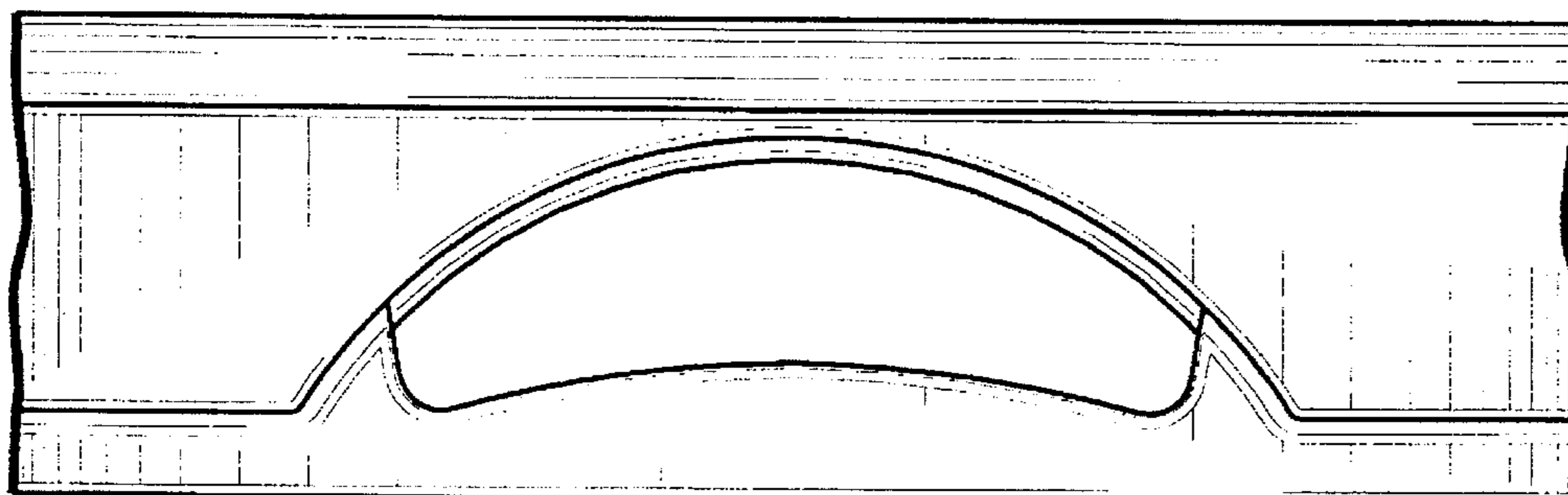

FIG. 4

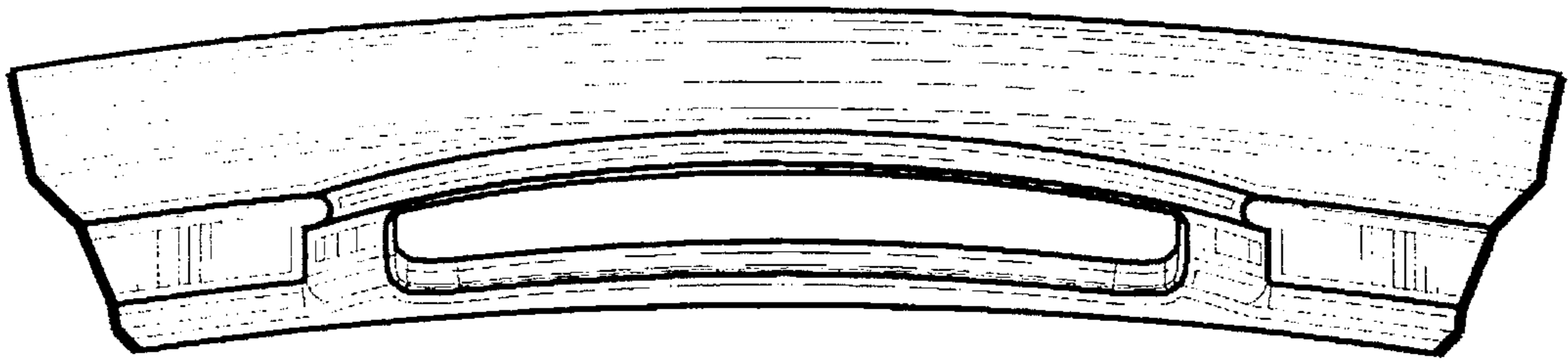

FIG. 5

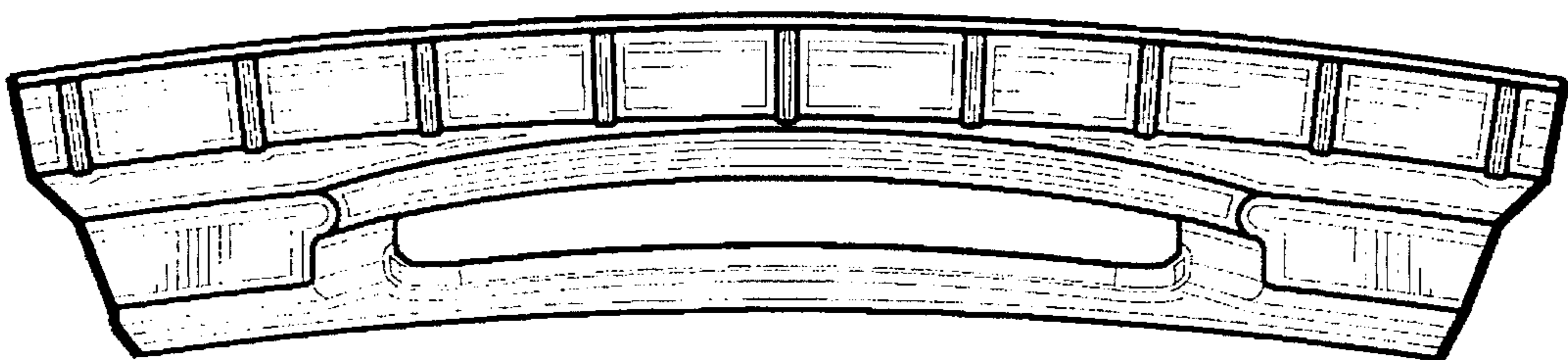

FIG. 6