



US00D376303S

United States Patent [19]

[11] **Patent Number: Des. 376,303**

Nagel

[45] **Date of Patent: **Dec. 10, 1996**

[54] **HAND DRILL**

D. 238,243	12/1975	Polivka	D8/14.1
D. 364,790	12/1995	Duennes	D8/61
4,254,667	3/1981	Wong	173/170
4,936,717	6/1990	Bosek	144/218

[75] Inventor: **Dietmar Nagel**, Chester, N.J.

[73] Assignee: **Azrak-Hamway International Inc.**,
New York, N.Y.

Primary Examiner—B. J. Bullock
Assistant Examiner—Robert M. Spear
Attorney, Agent, or Firm—Amster, Rothstein & Ebenstein

[**] Term: **14 Years**

[57] **CLAIM**

[21] Appl. No.: **41,446**

The ornamental design for a hand drill, as shown and described.

[22] Filed: **Jul. 14, 1995**

[52] U.S. Cl. **D8/61**

DESCRIPTION

[58] **Field of Search** D8/14.1, 61, 64,
D8/67, 68, 82; D24/146; 81/57, 57.11,
57.14, 177.4, 469, 474; 144/218, 150; 173/169,
170

FIG. 1 is a right side elevational view thereof;
FIG. 2 is a bottom plan view thereof;
FIG. 3 is a top plan view thereof;
FIG. 4 is a left side elevational view thereof;
FIG. 5 is a front elevational view thereof; and,
FIG. 6 is a rear elevational view thereof.

[56] **References Cited**

U.S. PATENT DOCUMENTS

D. 173,326 10/1954 Quackenbush D8/61

1 Claim, 3 Drawing Sheets

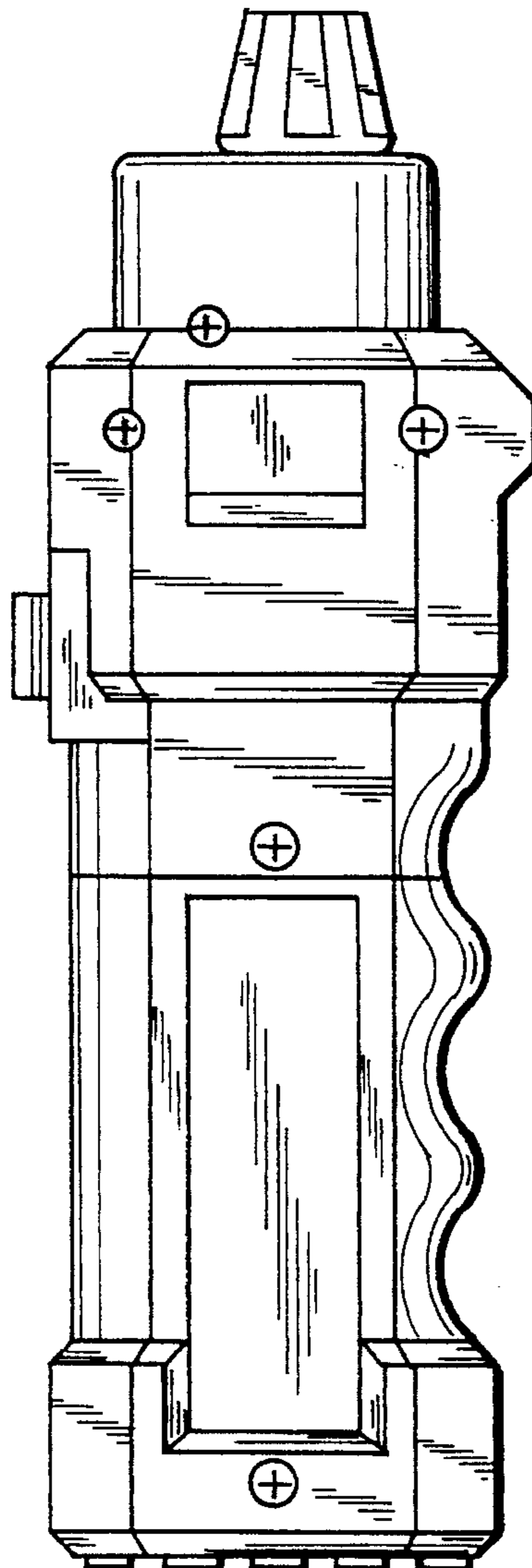

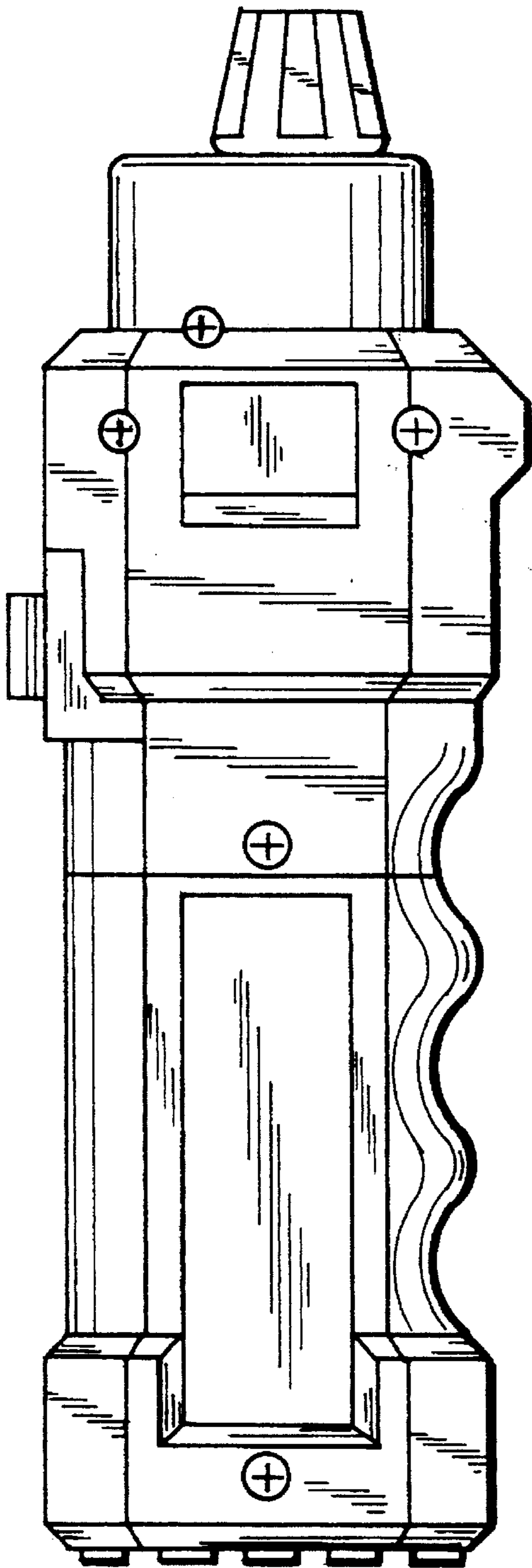

FIG. 1

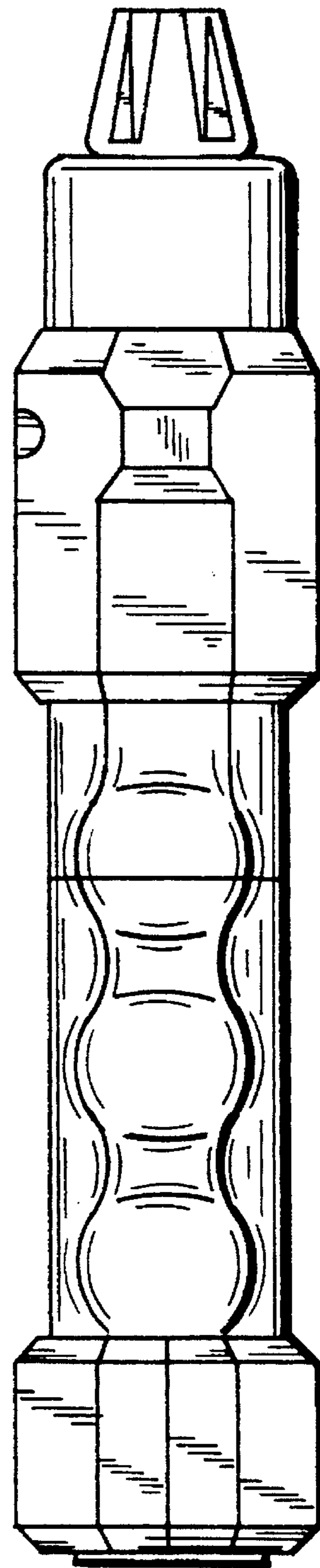

FIG. 2

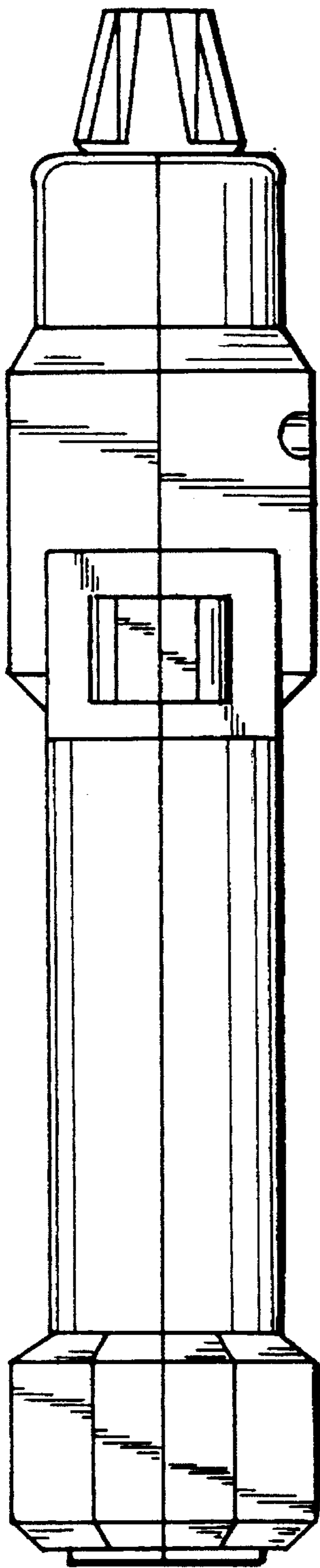

FIG. 3

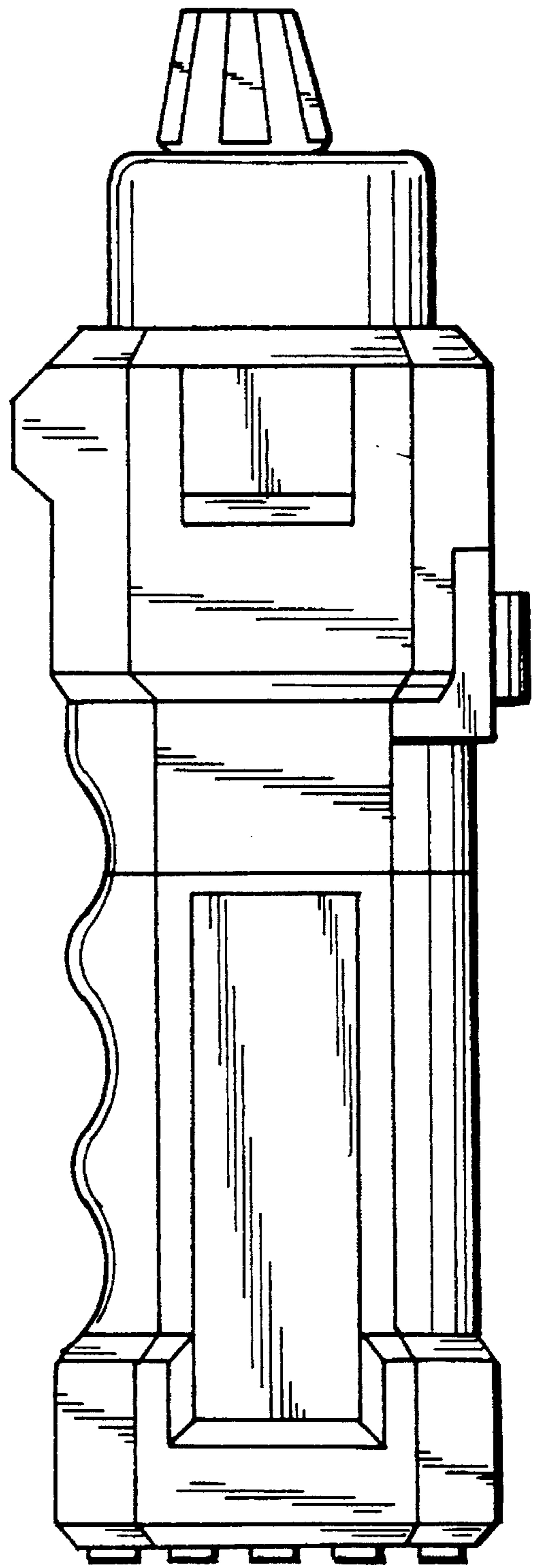

FIG. 4

FIG. 5

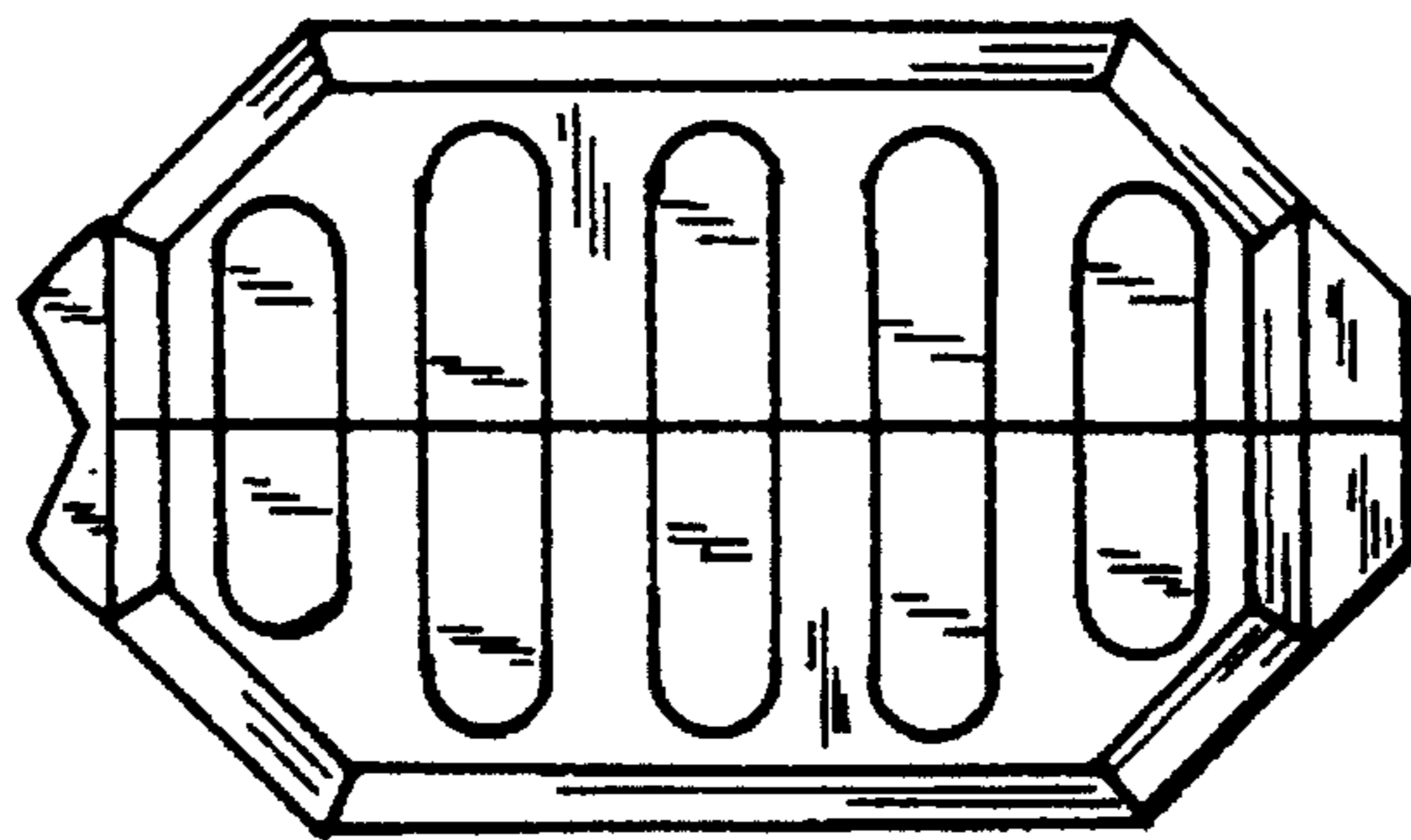
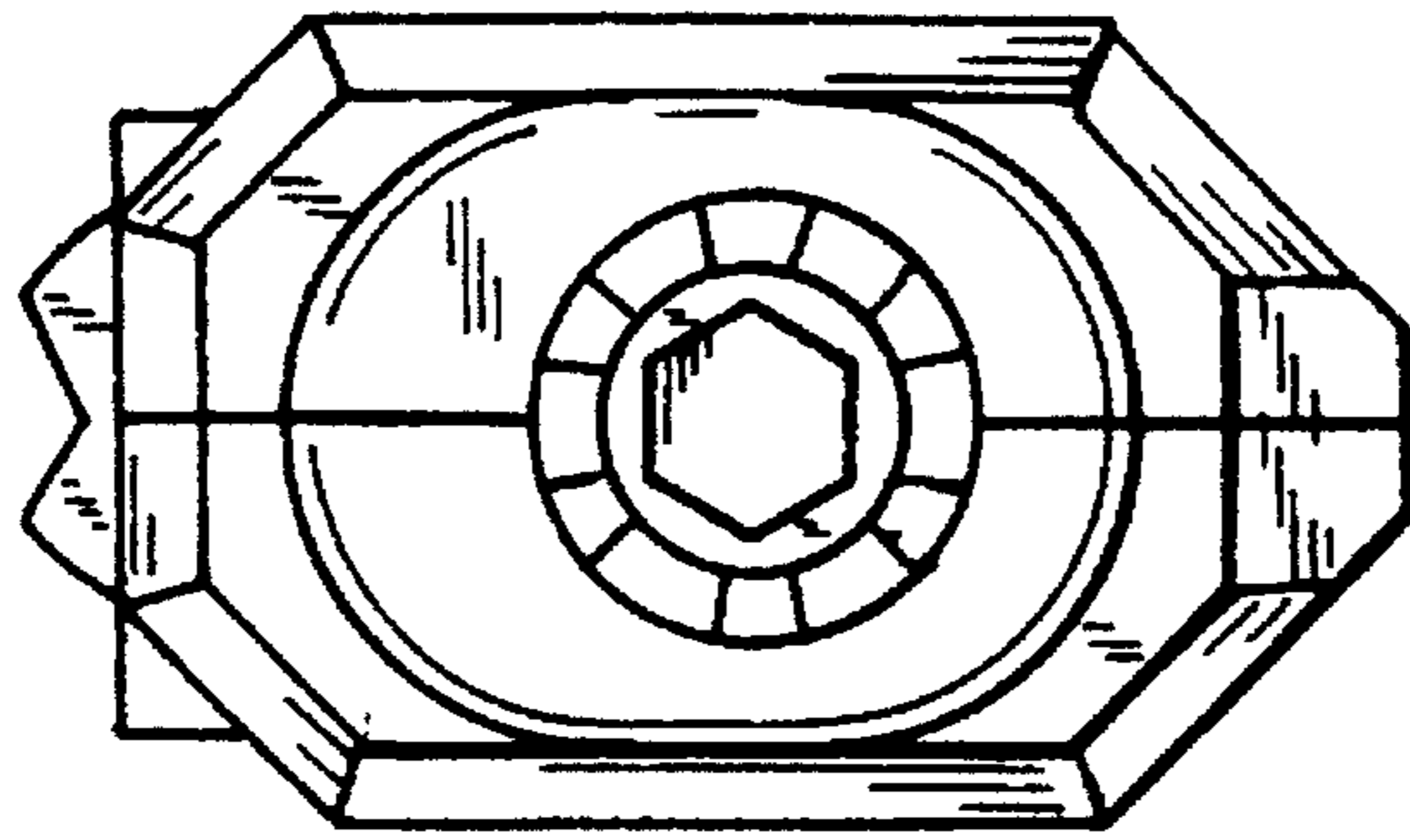

FIG. 6