



US00D376281S

United States Patent [19]
Robertson

[11] **Patent Number: Des. 376,281**
[45] **Date of Patent: **Dec. 10, 1996**

[54] **PLASTIC STACKABLE TABLE WITH NESTING REMOVABLE TRAY**

[75] Inventor: **Edward J. Robertson**, Winchester, Mass.

[73] Assignee: **Syroco, Inc.**, East Boston, Mass.

[**] Term: **14 Years**

[21] Appl. No.: **42,028**

[22] Filed: **Jul. 31, 1995**

[52] U.S. Cl. **D6/484**; D6/349

[58] Field of Search D6/480-484, 495, D6/451, 349; 108/153, 156, 161

[56] **References Cited**

U.S. PATENT DOCUMENTS

D. 224,194	7/1972	Logan .	
D. 293,635	1/1988	Goetz .	
D. 317,839	7/1991	Pino .	
D. 335,053	4/1993	Morin .	
D. 335,980	6/1993	Grosfillex	D6/484
D. 337,211	7/1993	Bergkvist	D6/349
D. 341,279	11/1993	Goetz .	
D. 359,406	6/1995	Crawford et al.	D6/484
2,131,122	9/1938	Schlett .	
2,542,648	2/1951	Flowers .	
2,857,227	10/1958	Jacques .	
4,779,541	10/1988	Milward .	

OTHER PUBLICATIONS

Product "A" Plastic Stackable Tray Table (photo reproduction), sold by Kay Home Products, circa 1994.

Product "B", Metal Tray Table with Wooden Base (photo reproduction), available for sale circa 1994, manufacturer unknown.

Primary Examiner—Janice E. Seeger

Attorney, Agent, or Firm—Sidley & Austin; Hugh A. Abrams

[57] **CLAIM**

The ornamental design for a plastic stackable table with nesting removable tray, as shown.

DESCRIPTION

FIG. 1 is a right, front perspective view of a plastic stackable table with a nesting removable tray showing my new design; FIG. 2 is a right side elevational view thereof; FIG. 3 is a front elevational view thereof; FIG. 4 is a top plan view thereof; FIG. 5 is a bottom plan view thereof; FIG. 6 is a right, front perspective exploded view thereof showing the tray removed; and, FIG. 7 is a right, front perspective view of my new design showing the plastic stackable table with the tray placed on the table in a position turned upside down from the nested position depicted in FIGS. 1-6.

1 Claim, 5 Drawing Sheets

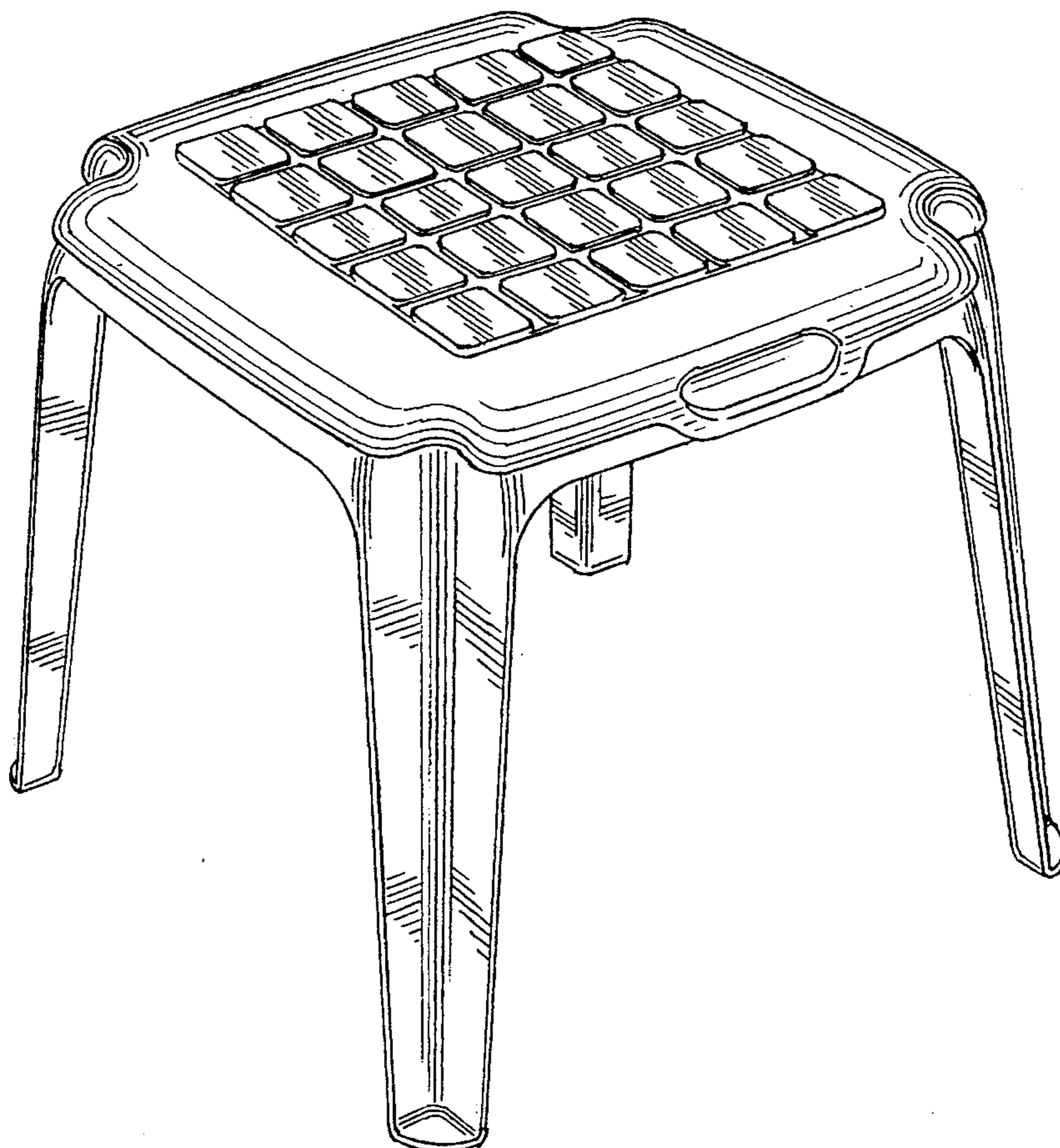

FIG. 1

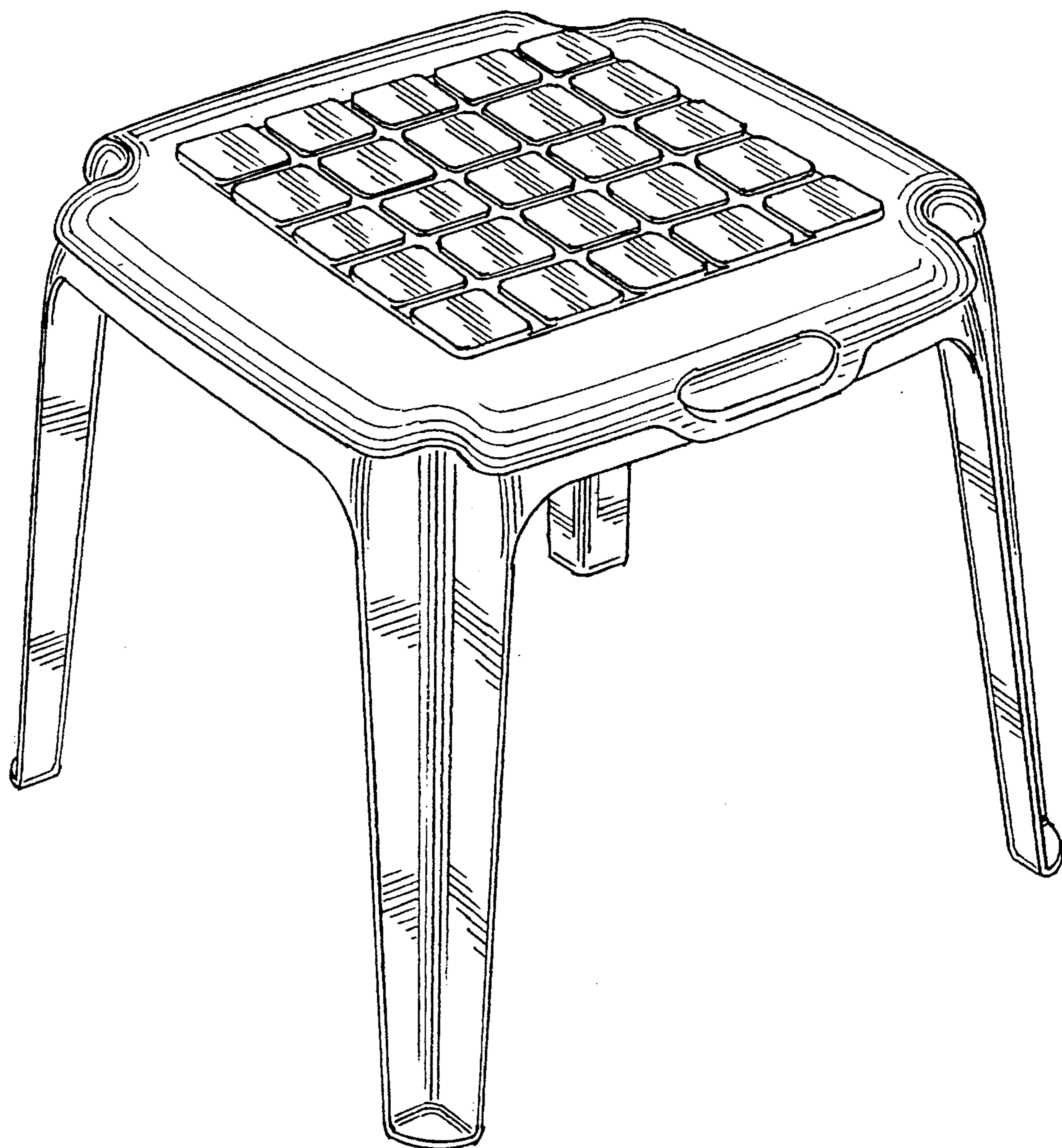

FIG.2

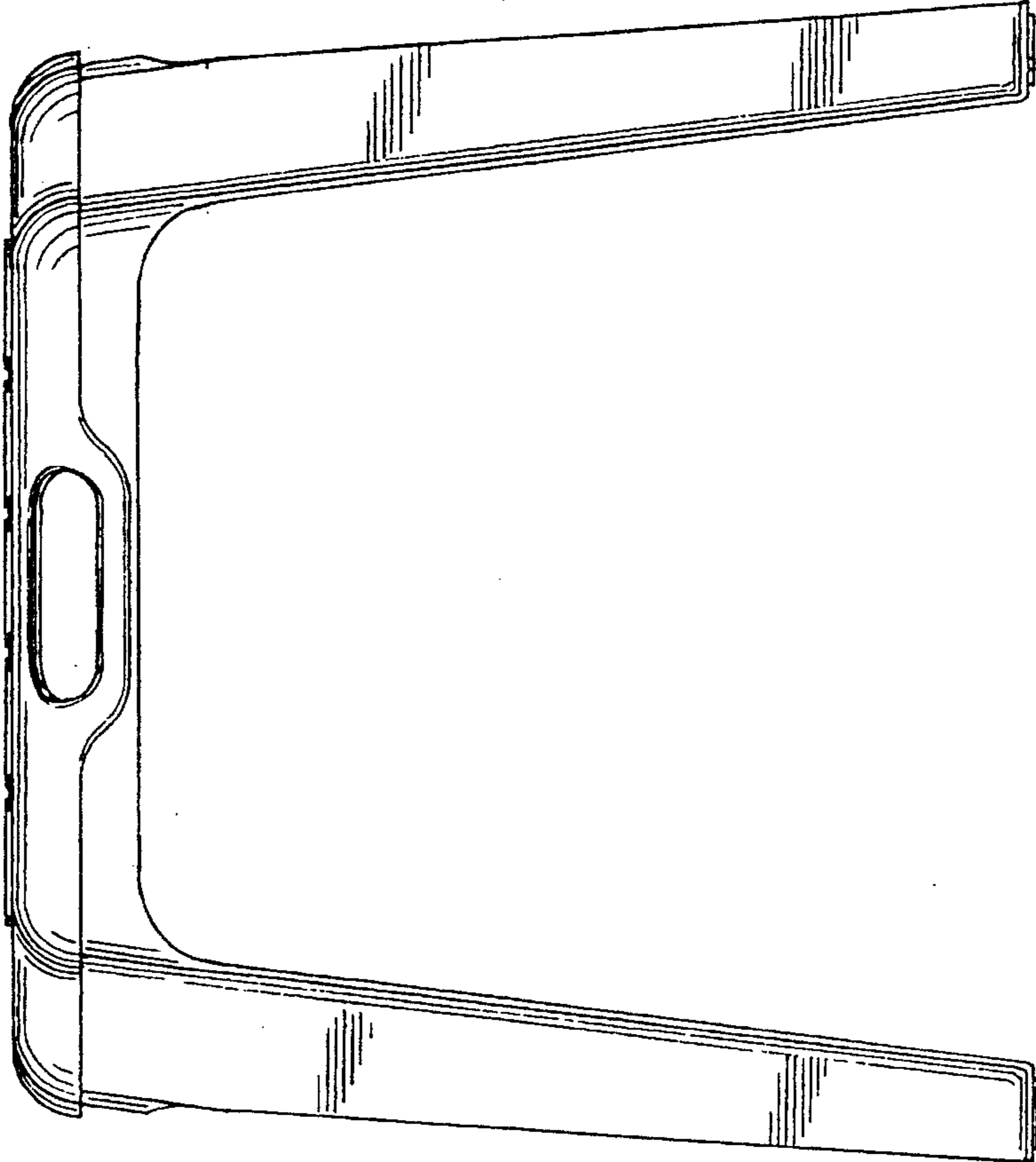
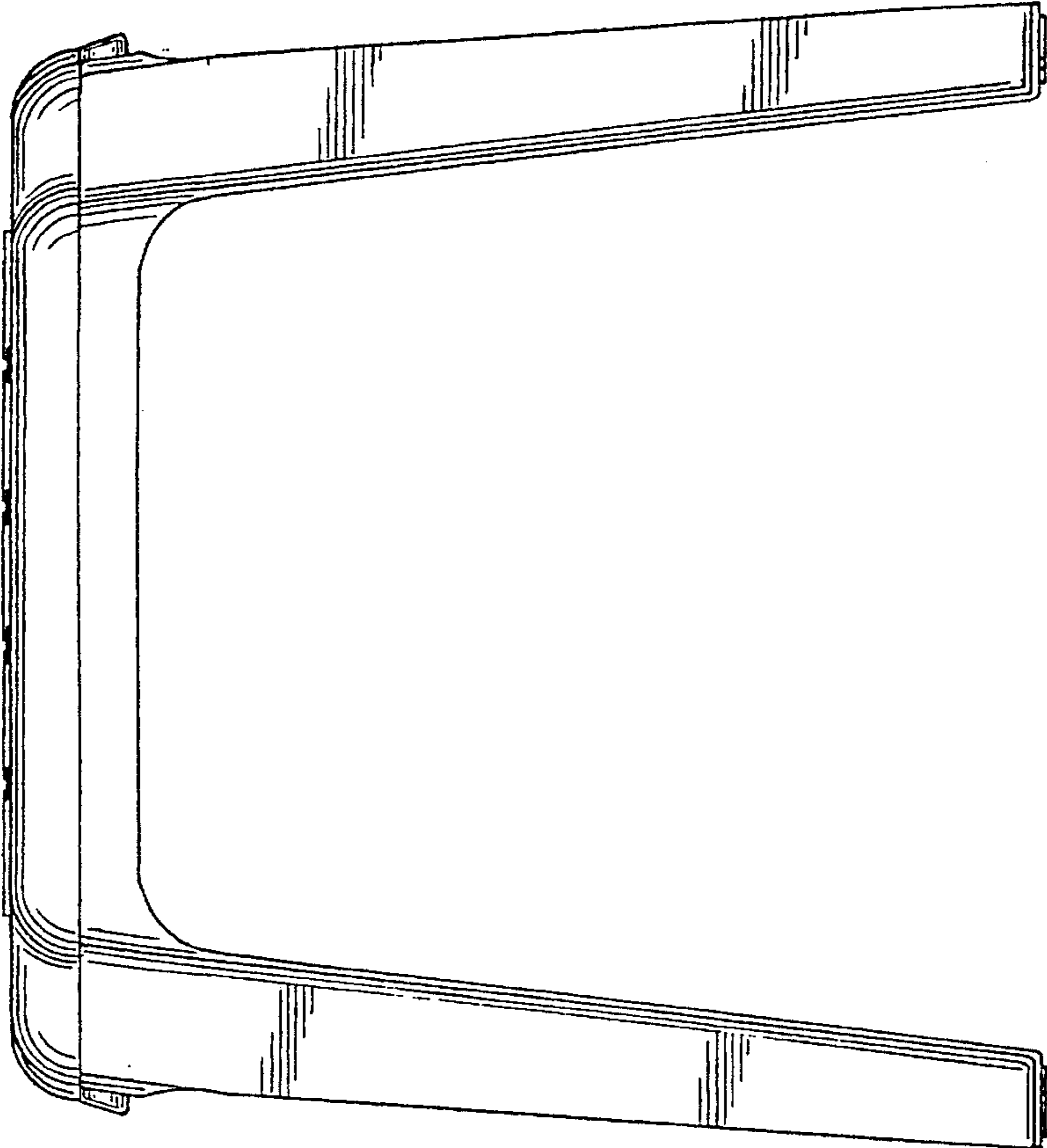

FIG.3



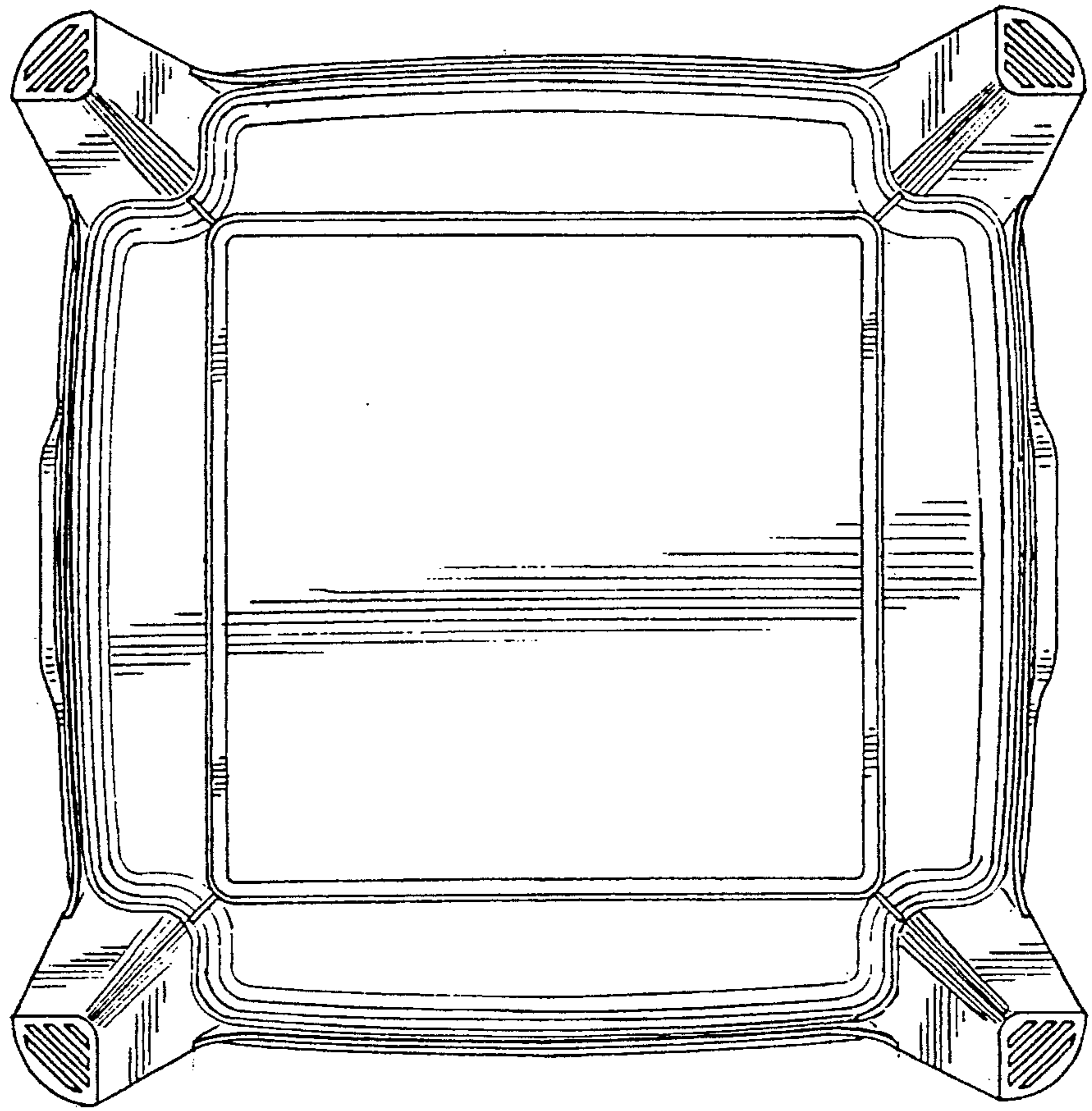

FIG. 5

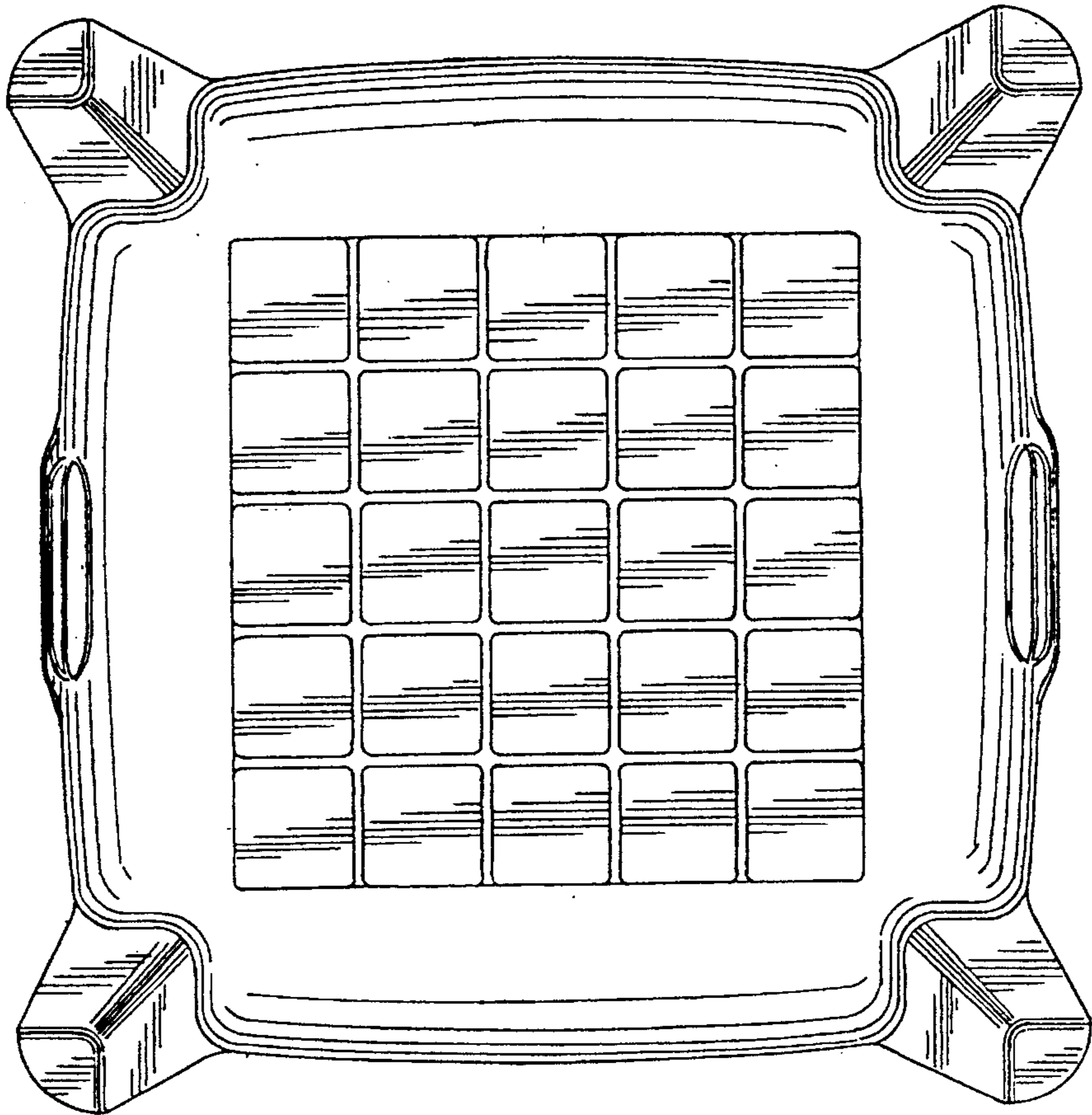

FIG. 4

FIG. 6

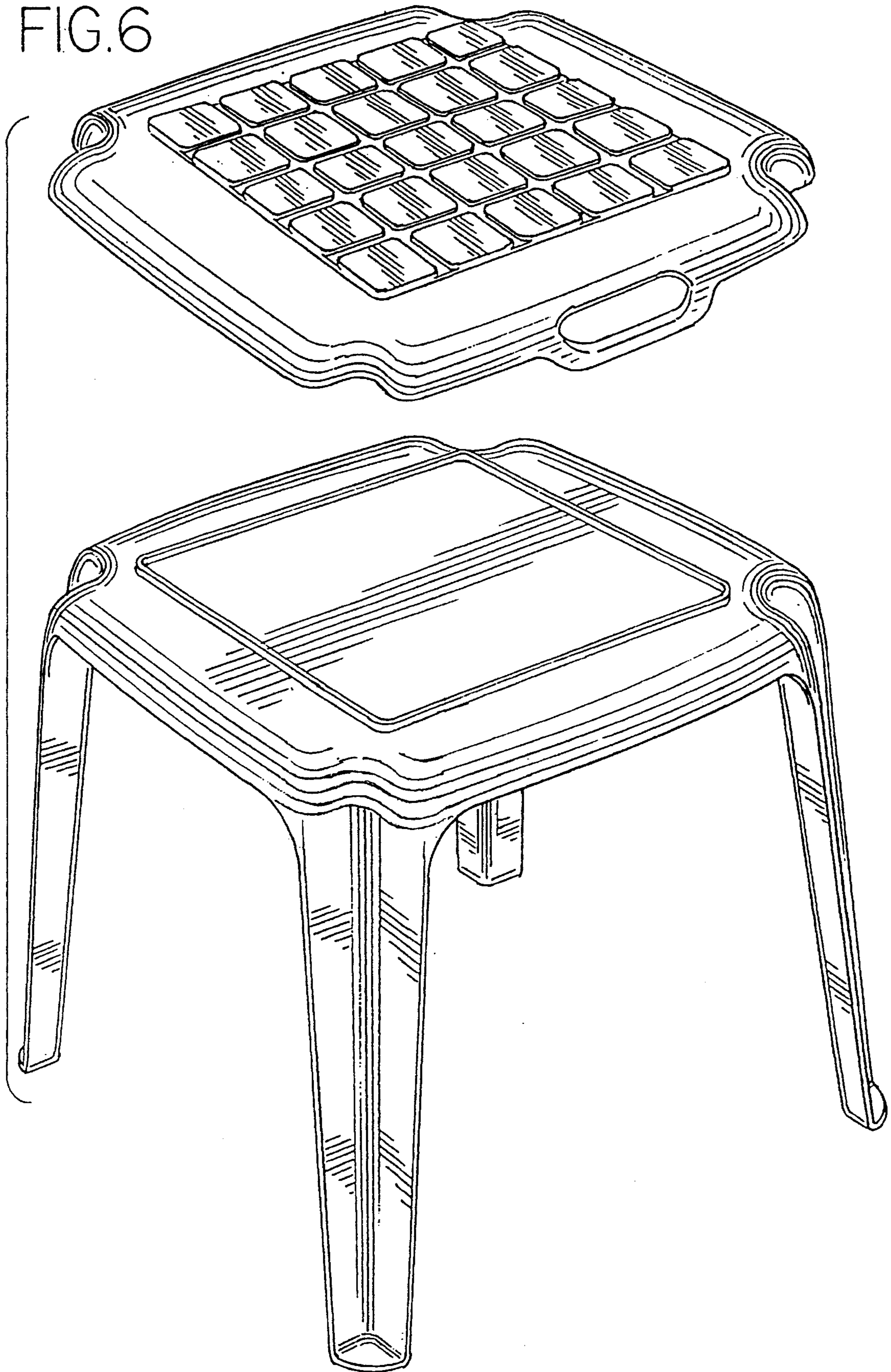

FIG. 7

