



US00D376261S

United States Patent [19]

Haddon

[11] Patent Number: Des. 376,261

[45] Date of Patent: **Dec. 10, 1996

[54] TOOTH BRUSH WITH REMOVABLE HEAD

5,033,154 7/1991 Marchand et al. 15/167.1

[76] Inventor: William C. Haddon, 730 E. St.,
Springfield, Oreg. 97477

Primary Examiner—A. Hugo Word

Assistant Examiner—Lavone D. Tabor

Attorney, Agent, or Firm—Harold H. Dutton, Jr.; W. Charles
L. Jamison; Diane S. Liebman

[**] Term: 14 Years

[21] Appl. No.: 29,315

[57] CLAIM

The ornamental design for a tooth brush with removable
head, as shown.

[22] Filed: Oct. 3, 1994

[52] U.S. Cl. D4/104; D4/121

[58] Field of Search D4/104–112, 121,
D4/130, 133–134, 136, 138; 15/143.1, 145,
159.1, 160, 167.1, 167.2, 176.1, 176.6,
186–187

DESCRIPTION

FIG. 1 is a front view of a tooth brush with removable head
showing my new design;

FIG. 2 is a rear view thereof;

FIG. 3 is a right side view thereof;

FIG. 4 is a left side view thereof;

FIG. 5 is a top plan view thereof; and

FIG. 6 is a bottom plan view thereof; and,

FIG. 7 is an exploded perspective view thereof.

[56] References Cited

U.S. PATENT DOCUMENTS

| | | | | |
|------------|---------|---------|-------|----------|
| D. 192,025 | 1/1962 | Rudnick | | D4/104 |
| D. 246,080 | 10/1977 | Rallis | | D4/104 |
| D. 293,859 | 1/1988 | Gjerde | | D4/104 |
| 4,683,604 | 8/1987 | Rueb | | 15/176.1 |

1 Claim, 4 Drawing Sheets

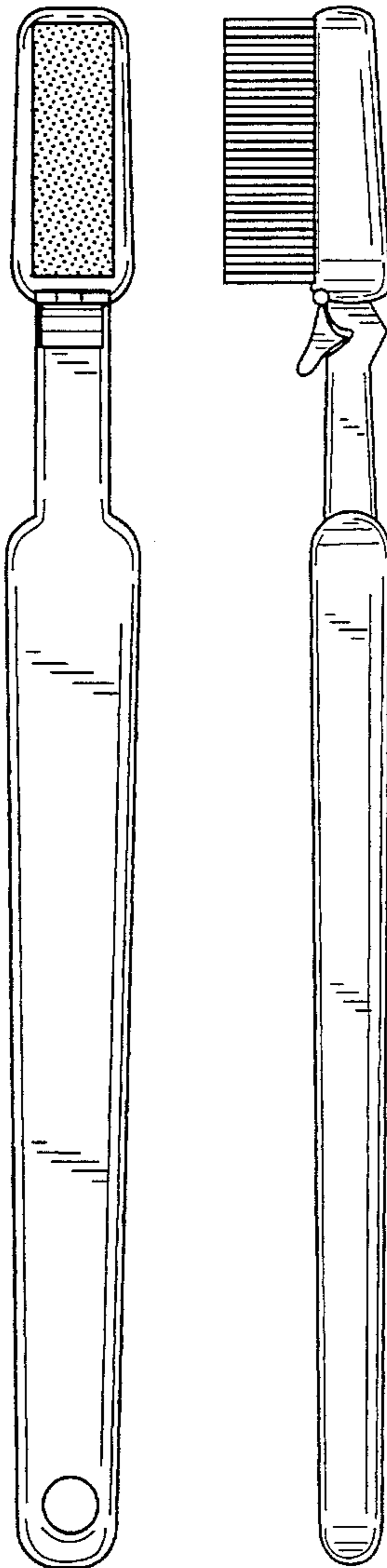

FIG. 1

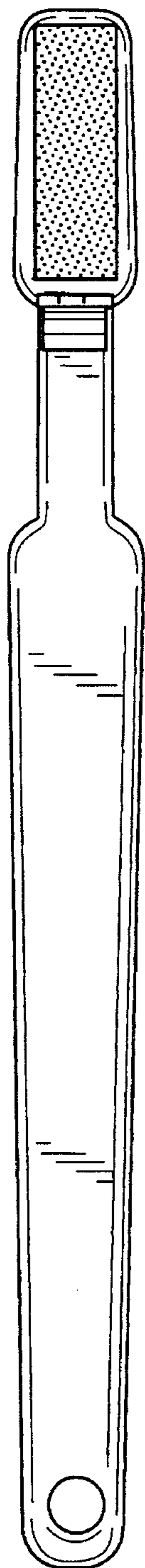
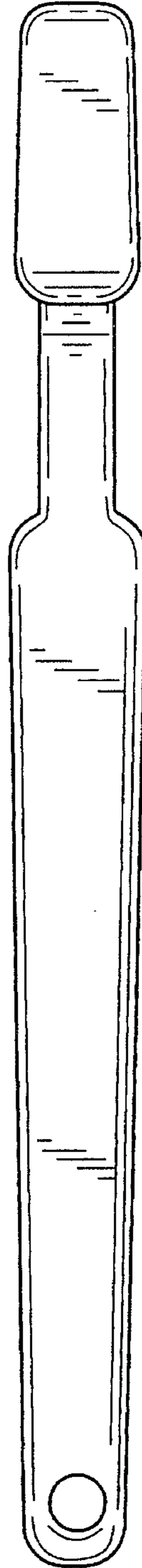

FIG. 2



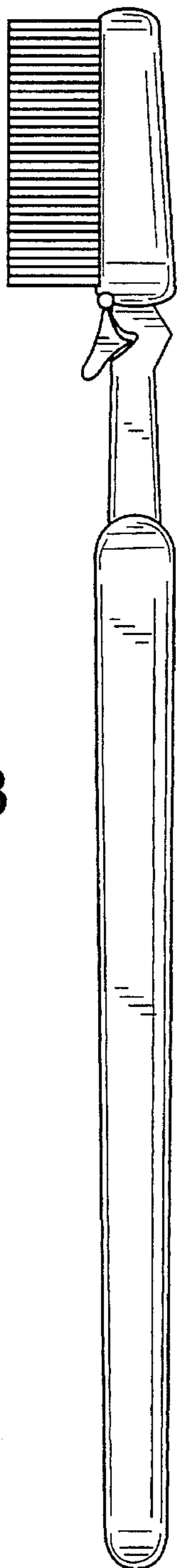

FIG. 3

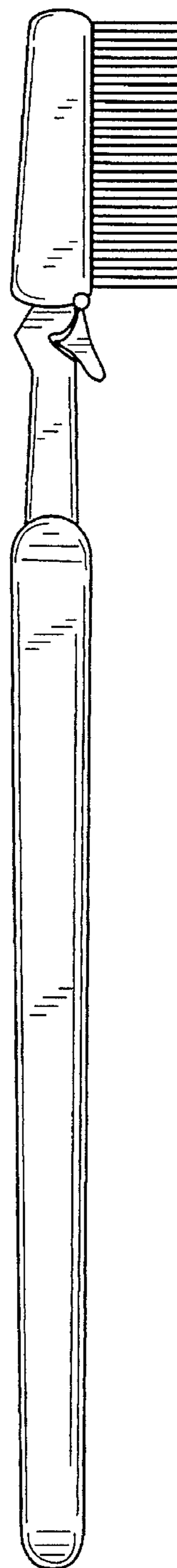

FIG. 4

FIG. 5

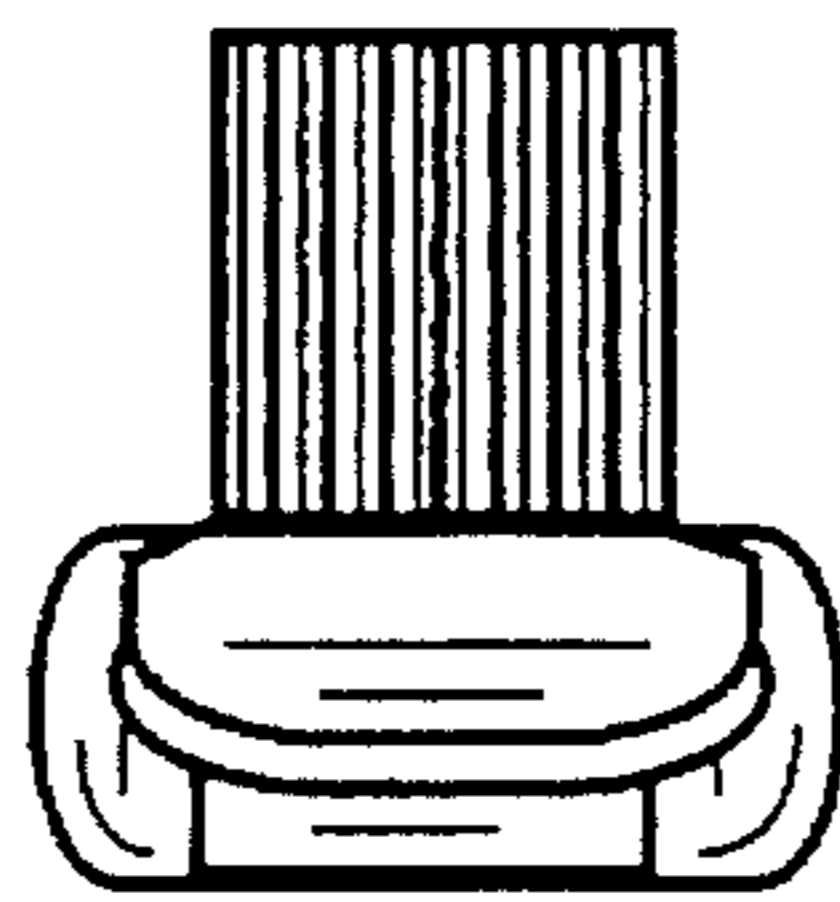
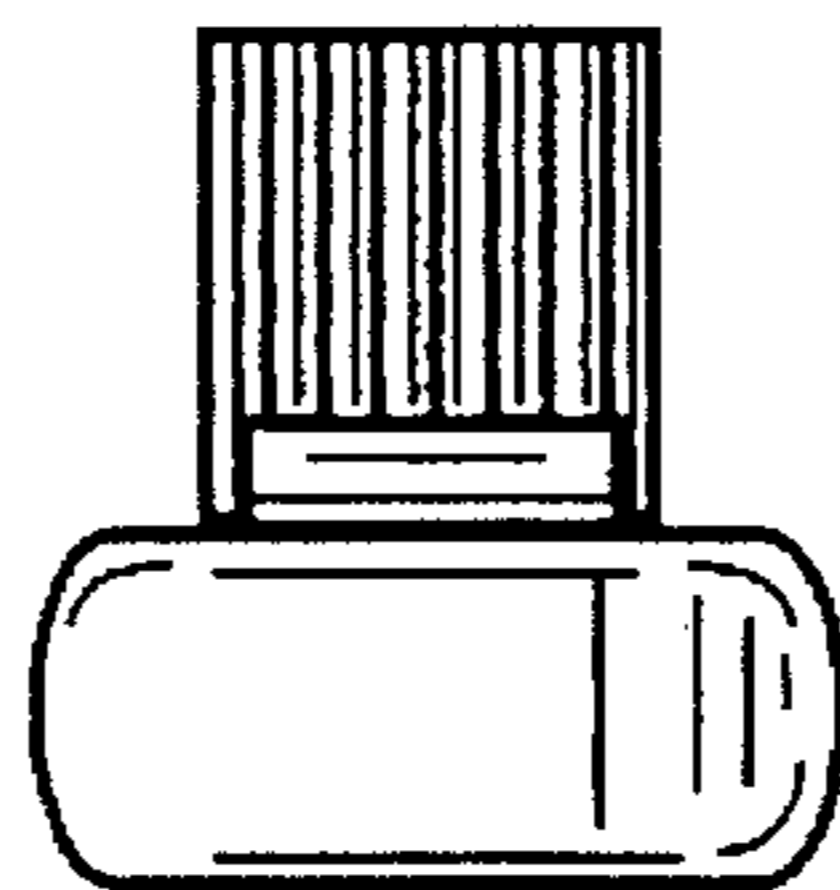

FIG. 6



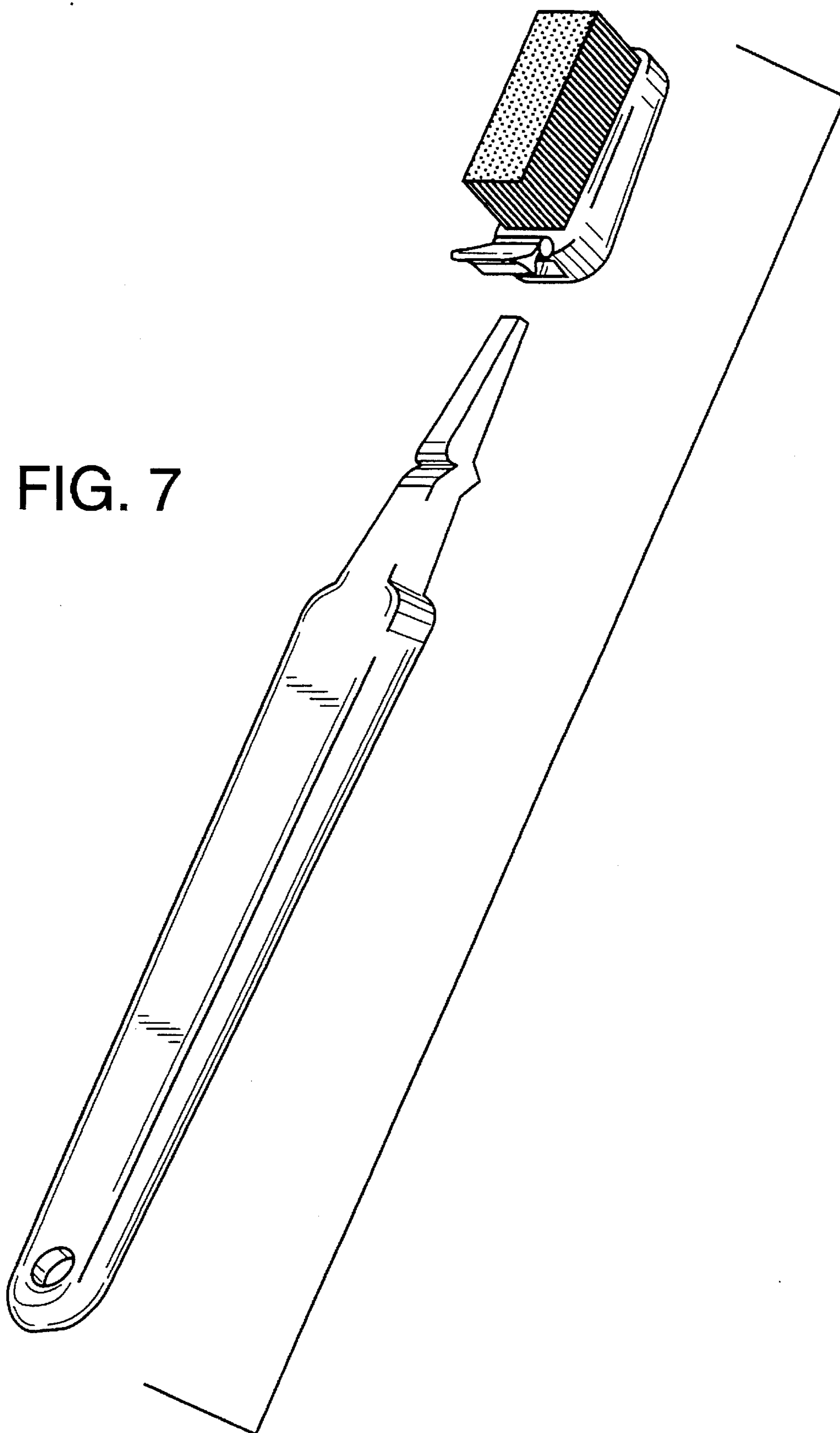

FIG. 7