



US00D376250S

United States Patent [19]

[11] **Patent Number: Des. 376,250**

Conley, Jr.

[45] **Date of Patent: **Dec. 3, 1996**

[54] **ALL-SPORTS MAILBOX**

OTHER PUBLICATIONS

[76] Inventor: **Willis Conley, Jr.**, 1795 Zuber Rd.,
Grove City, Ohio 43123

Bruce Bolind Cat. p. 80, NFL Helmet Mailbox.

[**] Term: **14 Years**

Primary Examiner—B. J. Bullock

Assistant Examiner—S. Snapp

[21] Appl. No.: **40,585**

[57] **CLAIM**

[22] Filed: **Jun. 22, 1995**

The ornamental design for a all-sports mailbox, as shown and described.

[52] U.S. Cl. **D99/30**

DESCRIPTION

[58] **Field of Search** D99/30, 29; D29/102,
D29/103, 105; D9/307, 319, 320; D11/131;
232/1 C, 17, 19, 25, 26, 27, 28, 37, 38,
39

FIG. 1 is a front elevational view of the all-sports mailbox showing my new design;
FIG. 2 is a rear elevational view thereof;
FIG. 3 is a left side elevational view thereof;
FIG. 4 is a right side elevational view thereof;
FIG. 5 is a top plan view thereof;
FIG. 6 is a bottom plan view thereof; and,
FIG. 7 is a left side elevational view with the door in an open position.

[56] **References Cited**

U.S. PATENT DOCUMENTS

D. 309,509	7/1990	Mast	D29/103
D. 320,476	10/1991	Mele	D29/103
D. 344,659	3/1994	Hsu	D9/307 X
D. 349,630	8/1994	Redmon	D9/307 X

1 Claim, 4 Drawing Sheets

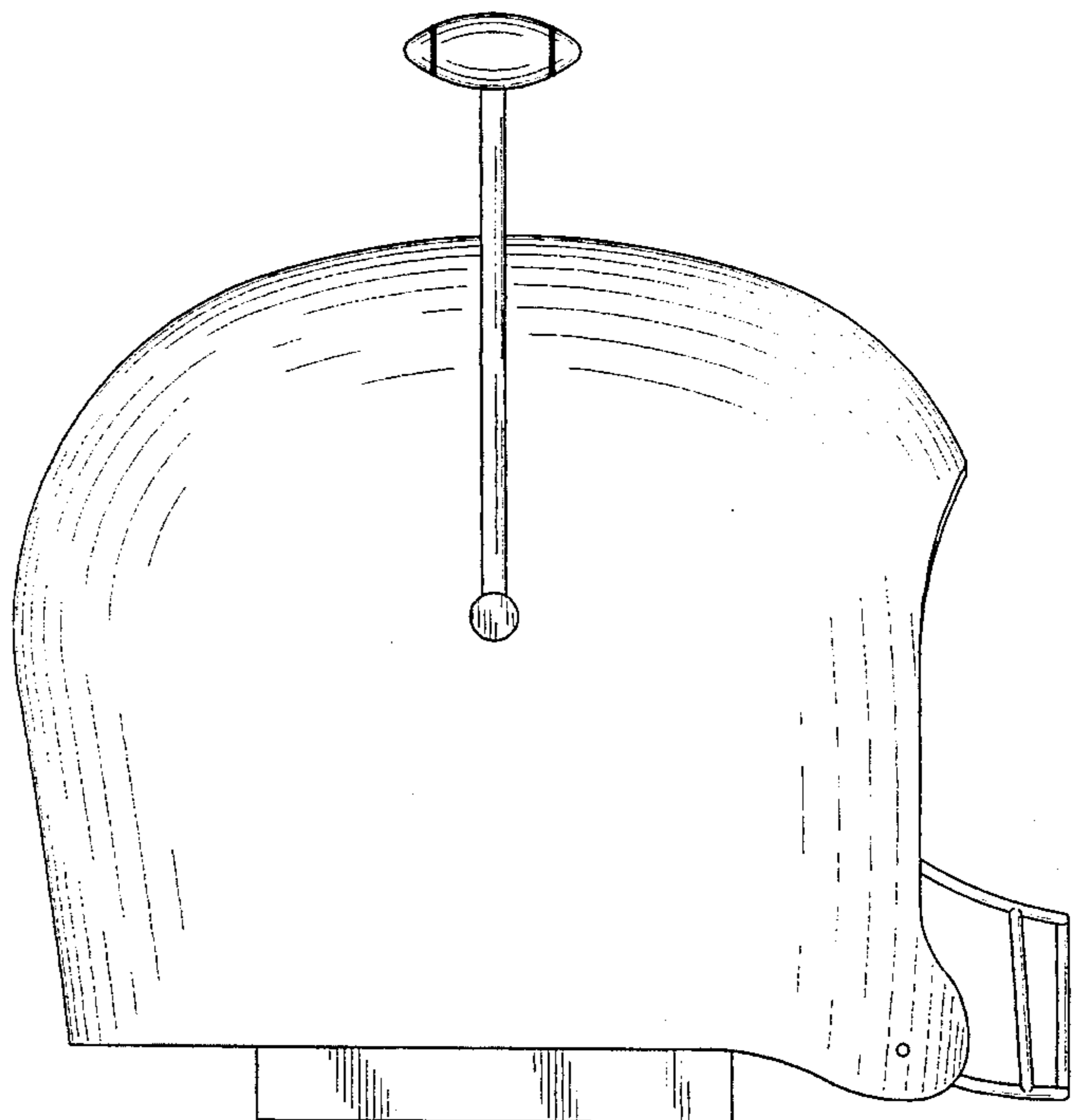
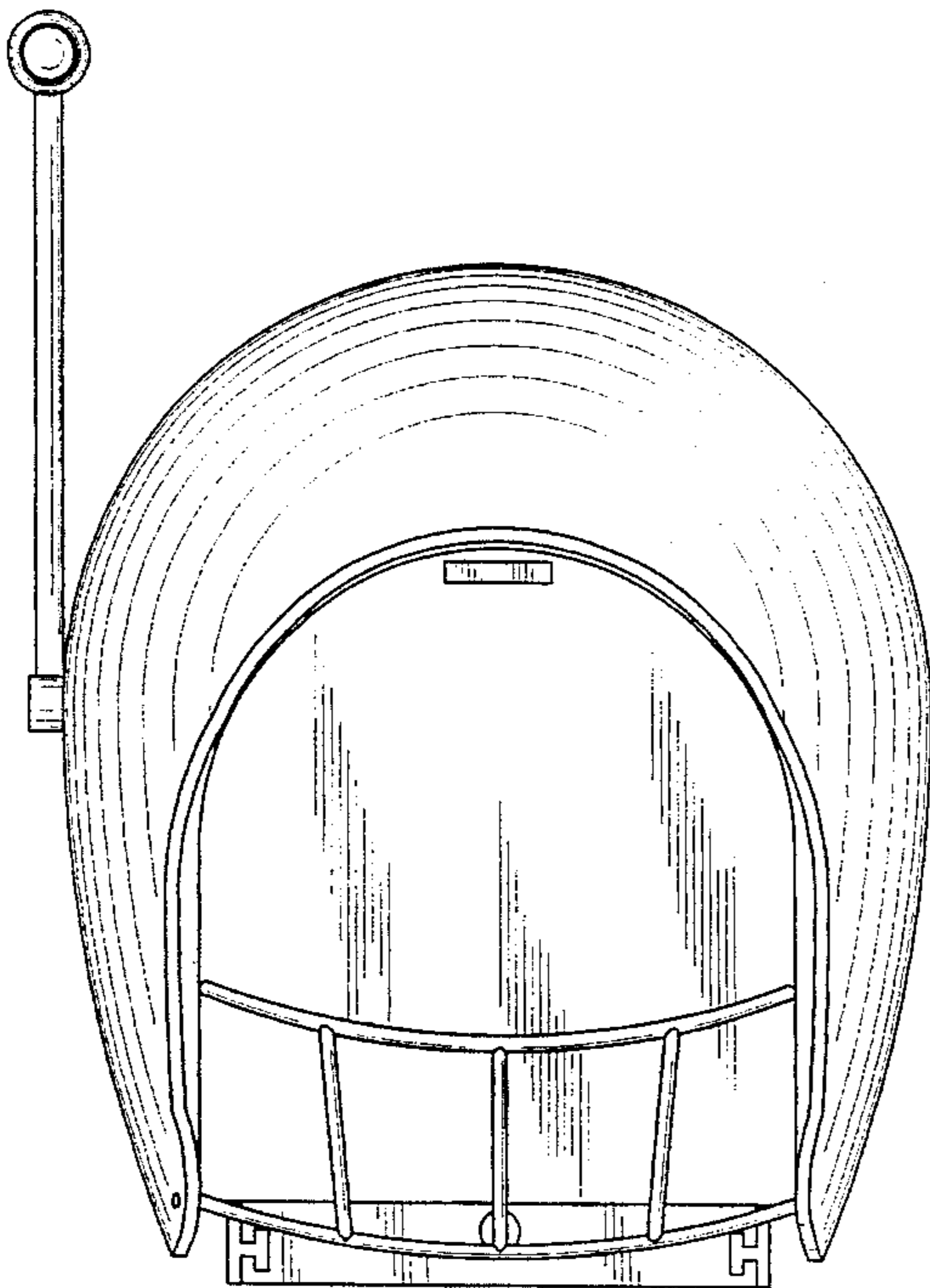

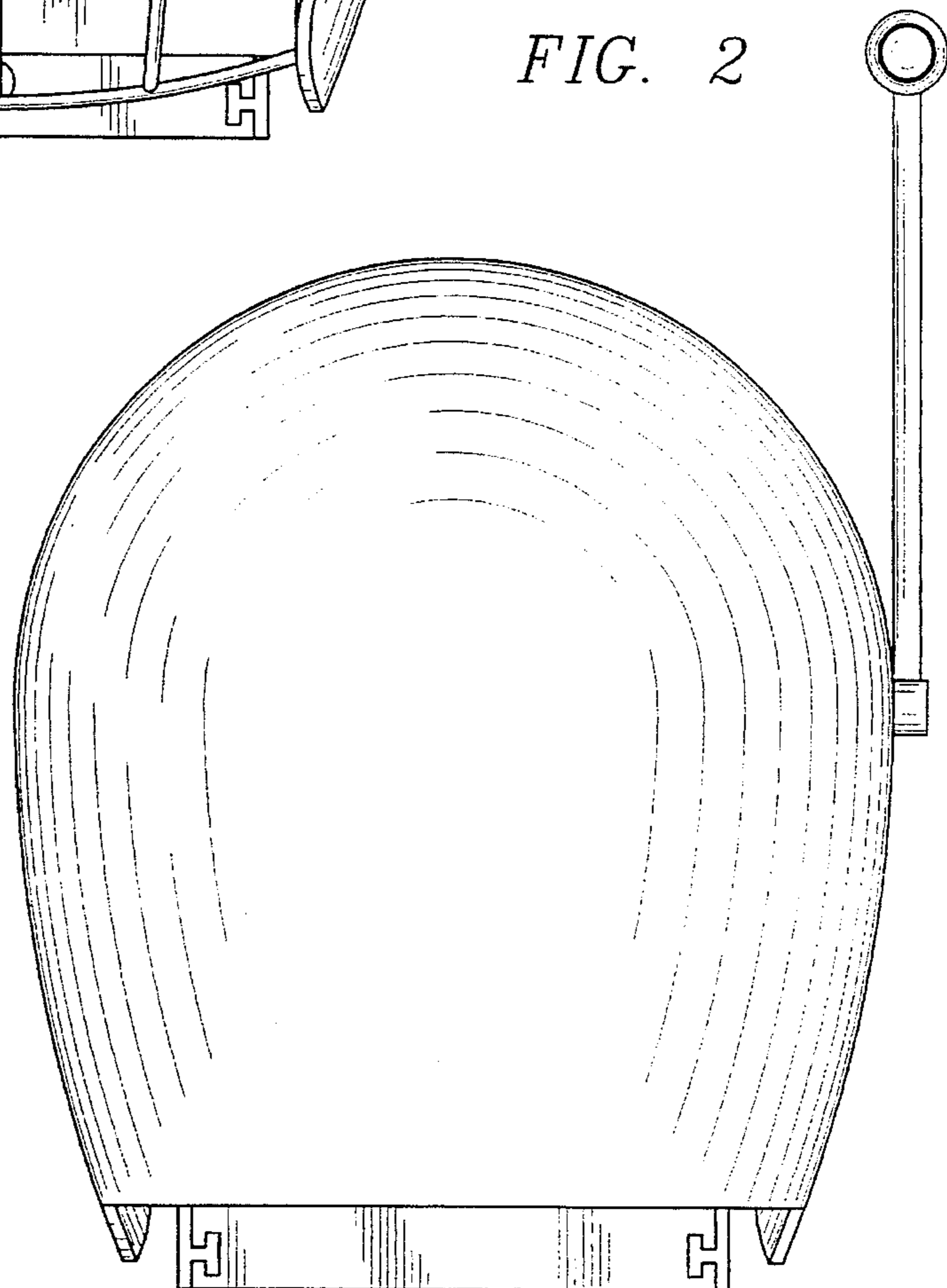
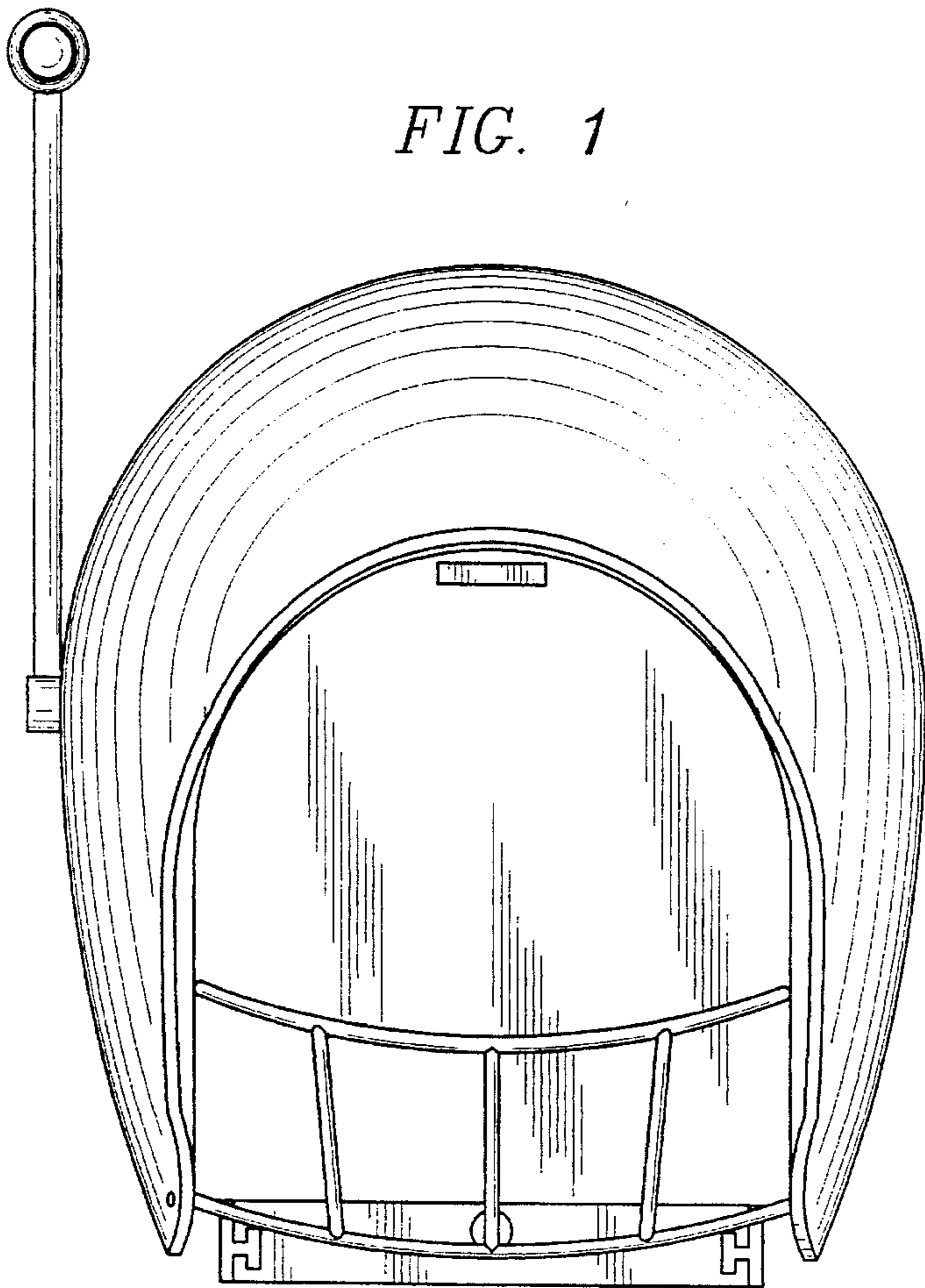

FIG. 3

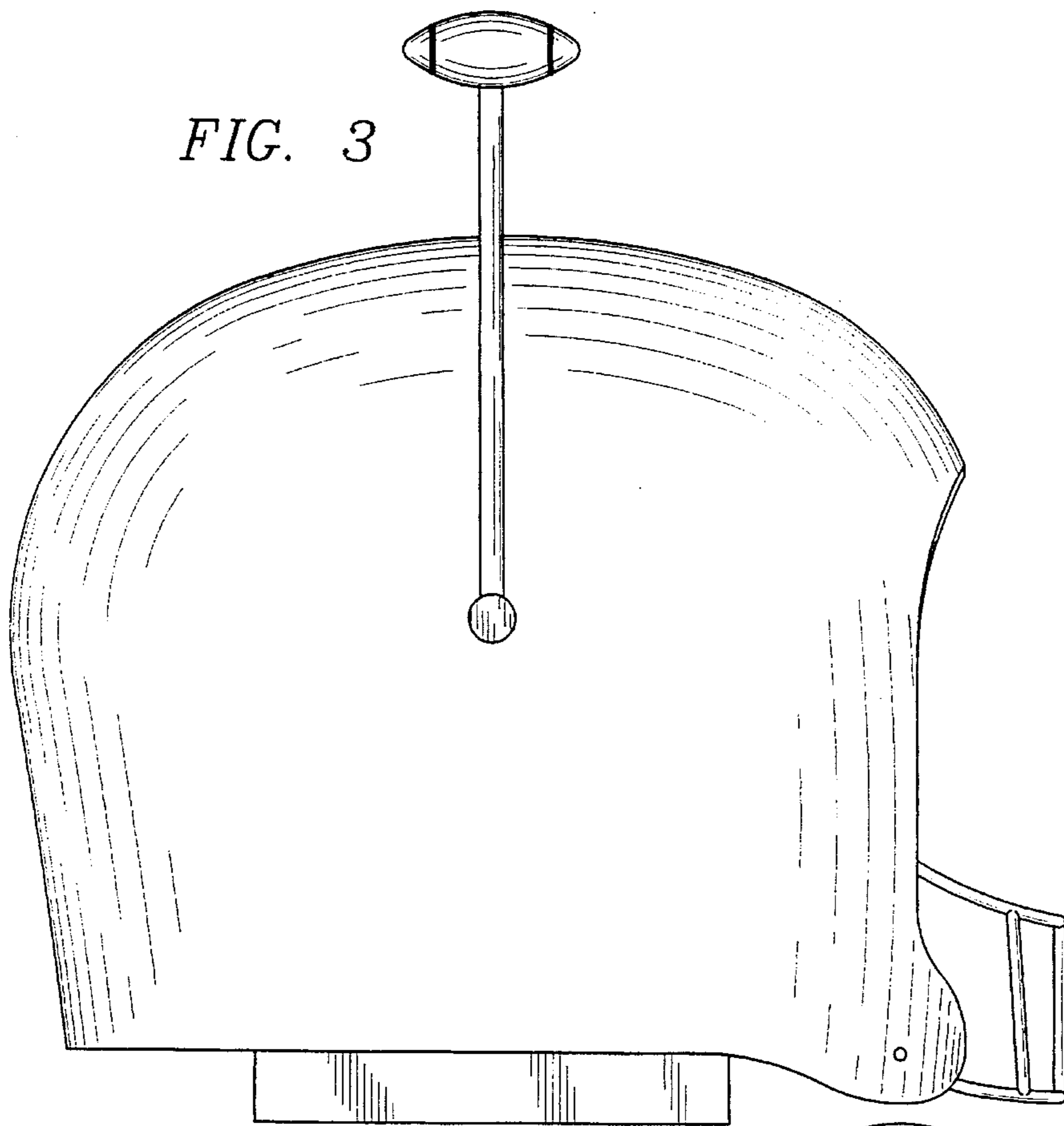

FIG. 4

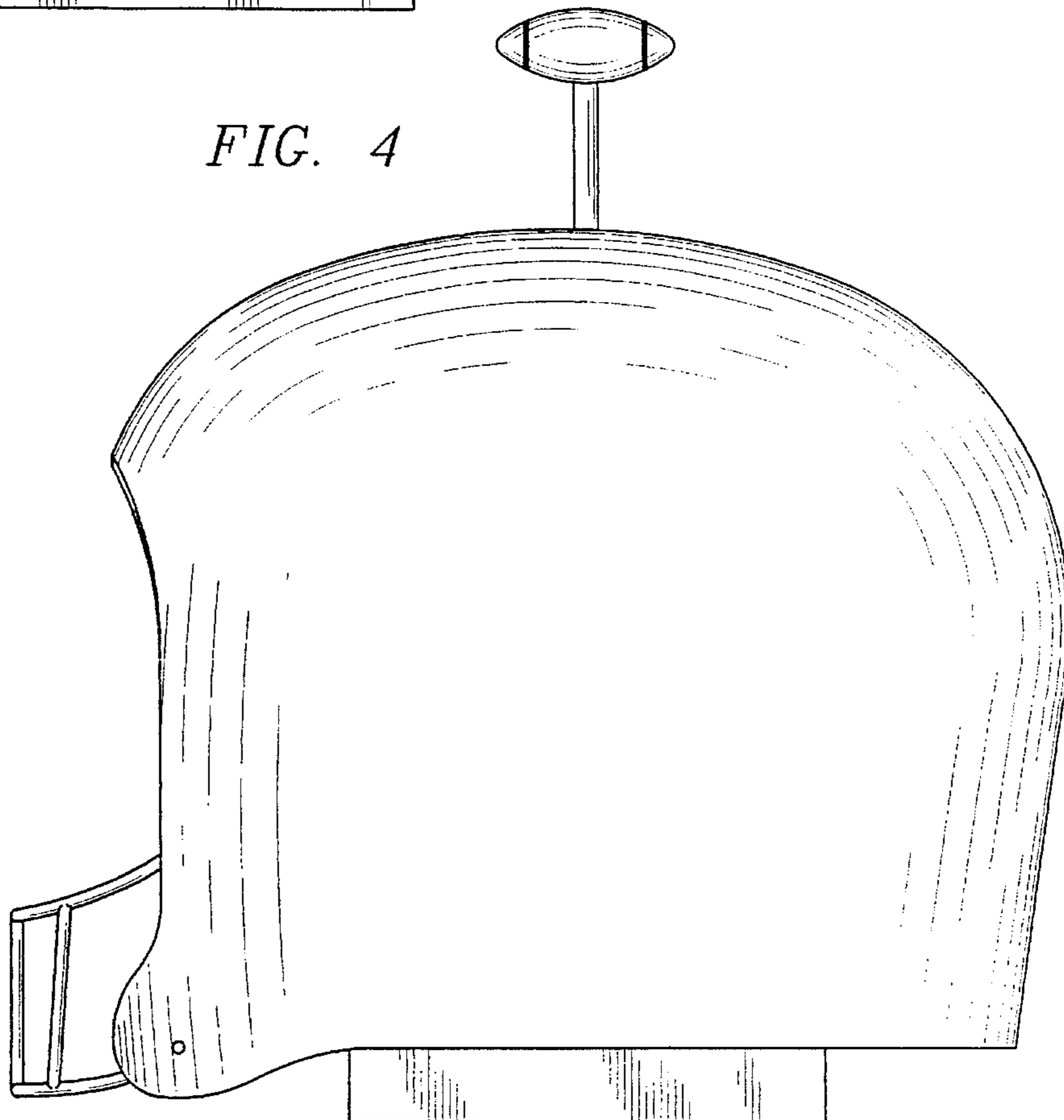

FIG. 5

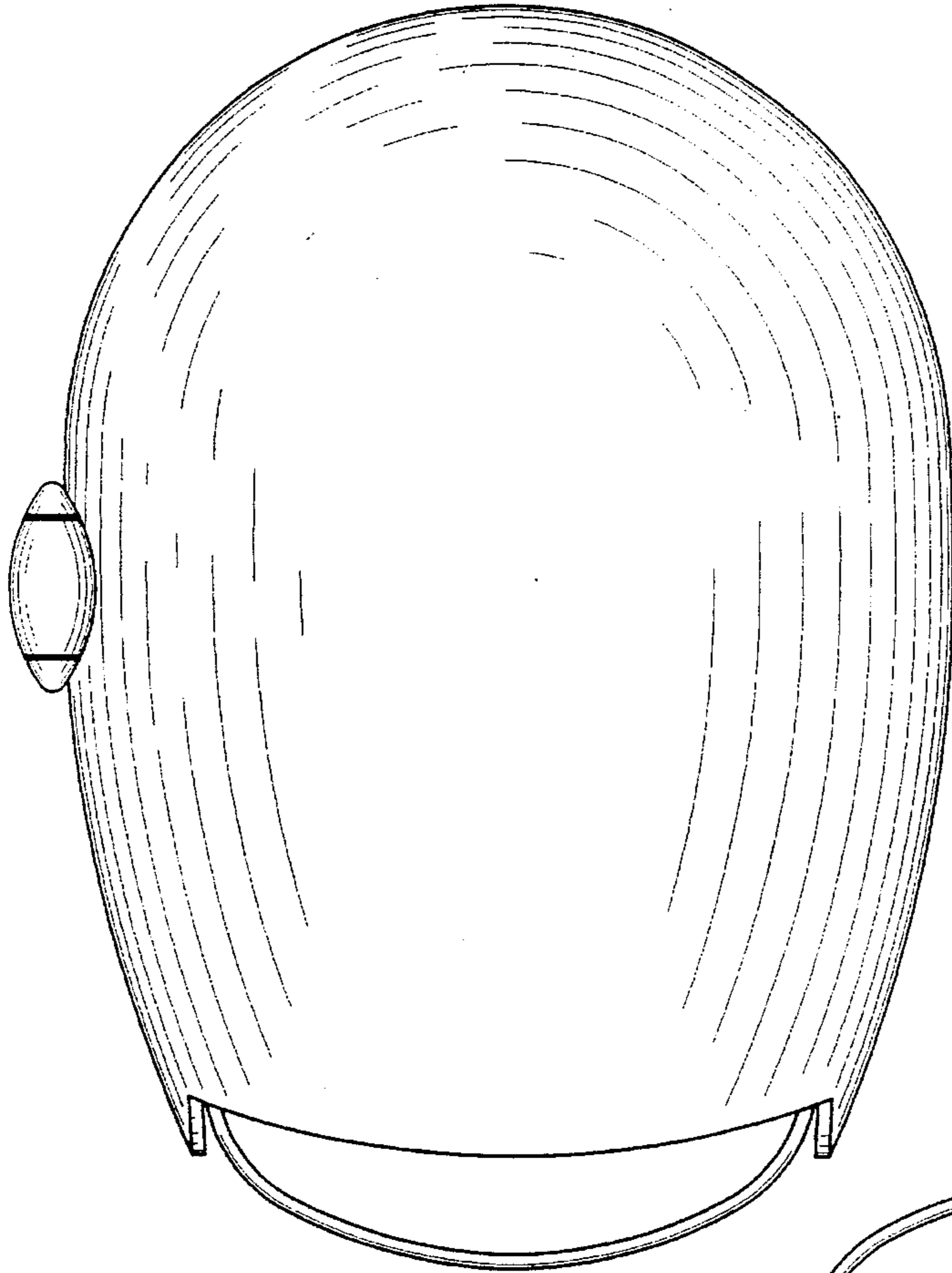

FIG. 6

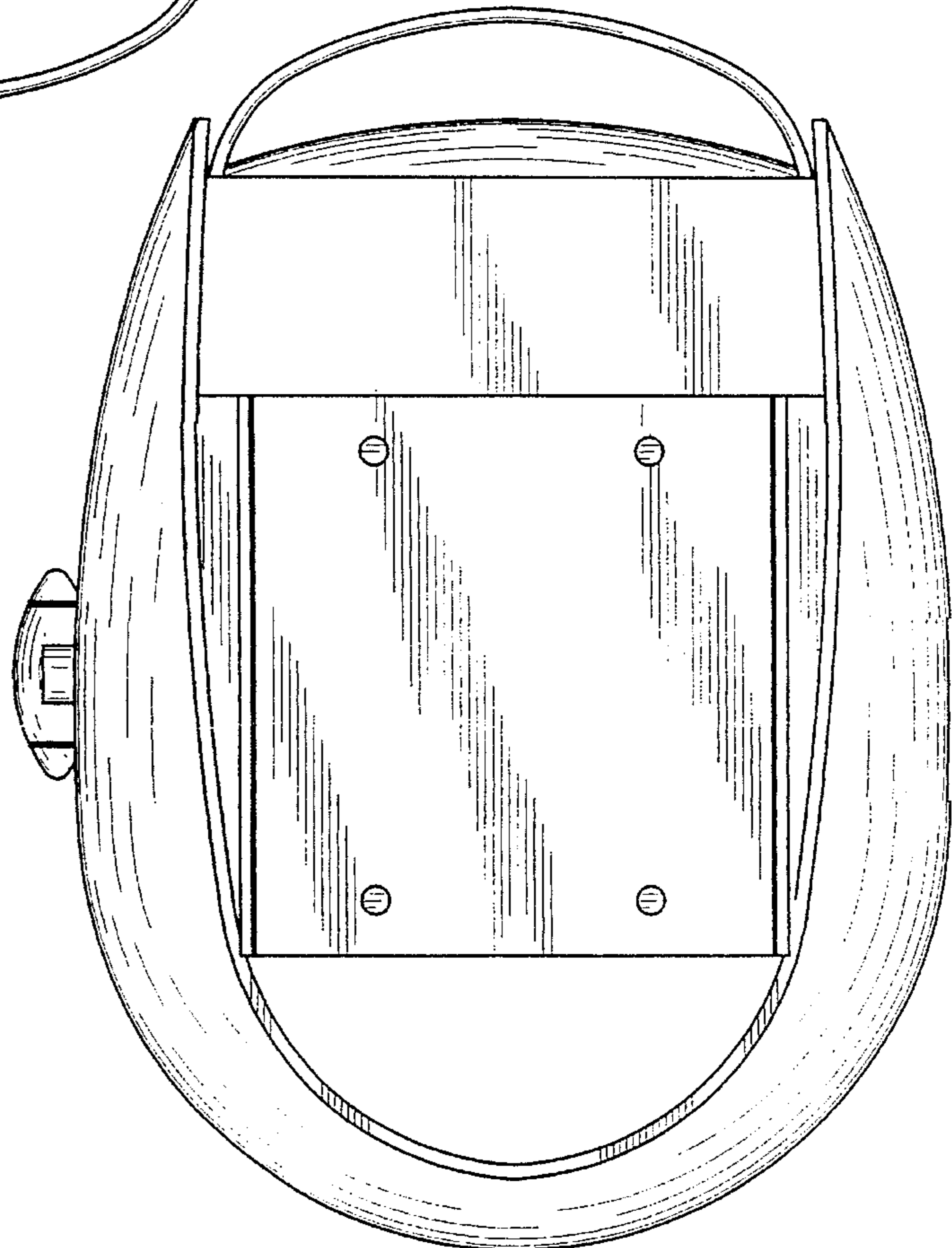

FIG. 7

