



US00D376187S

United States Patent [19]

Haber et al.

[11] Patent Number: **Des. 376,187**

[45] Date of Patent: ****Dec. 3, 1996**

[54] PISTOL MAGAZINE

5,357,703 10/1994 Chestnut et al. 42/50

[75] Inventors: **Terry M. Haber**, El Toro; **William H. Smedley**, Lake Elsinore; **Clark B. Foster**, Laguna Niguel, all of Calif.

Primary Examiner—Louis S. Zarfaz
Assistant Examiner—Monica A. Hannon
Attorney, Agent, or Firm—Hawes, Fischer & Dickinson

[73] Assignee: **Habley Medical Technology Corporation**, Lake Forest, Calif.

[57] **CLAIM**

[**] Term: **14 Years**

The ornamental design for a pistol magazine, as shown and described.

[21] Appl. No.: **45,531**

DESCRIPTION

[22] Filed: **Oct. 23, 1995**

[52] U.S. Cl. **D22/108; D22/199**

[58] **Field of Search** D22/100, 103, D22/104, 105, 108, 199; D21/145, 146, 147; 42/7, 18, 22, 49.02, 50

FIG. 1 is a perspective view showing the top, the left side and the rear of the pistol magazine which forms our invention;

FIG. 2 is a left side elevational view thereof;

FIG. 3 is a right side elevational view thereof;

FIG. 4 is a top plan view thereof;

FIG. 5 is a bottom plan view thereof;

FIG. 6 is a front elevational view thereof;

FIG. 7 is a rear elevational view thereof; and,

FIG. 8 is a left side elevational view showing our pistol magazine moving into receipt by a pistol, the phantom lines representing the pistol being shown for illustrative purposes only and forming no part of our new design.

[56] **References Cited**

U.S. PATENT DOCUMENTS

D. 362,044	9/1995	Sniezak	D22/100 X
4,502,237	3/1985	Krogh	42/50
4,747,224	5/1988	Smith	42/7
5,052,138	10/1991	Crain	42/7
5,309,660	5/1994	Blackamore	42/50

1 Claim, 4 Drawing Sheets

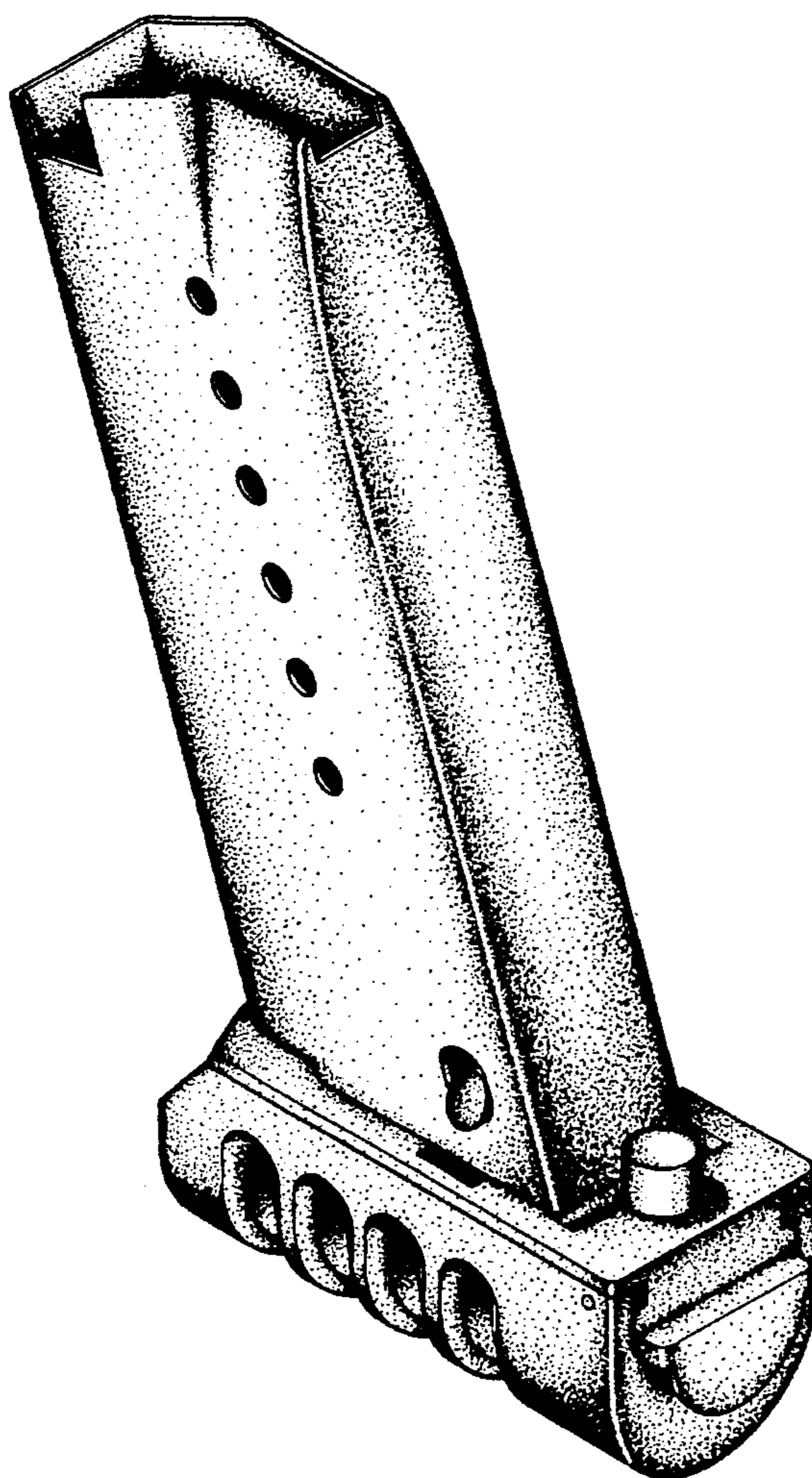

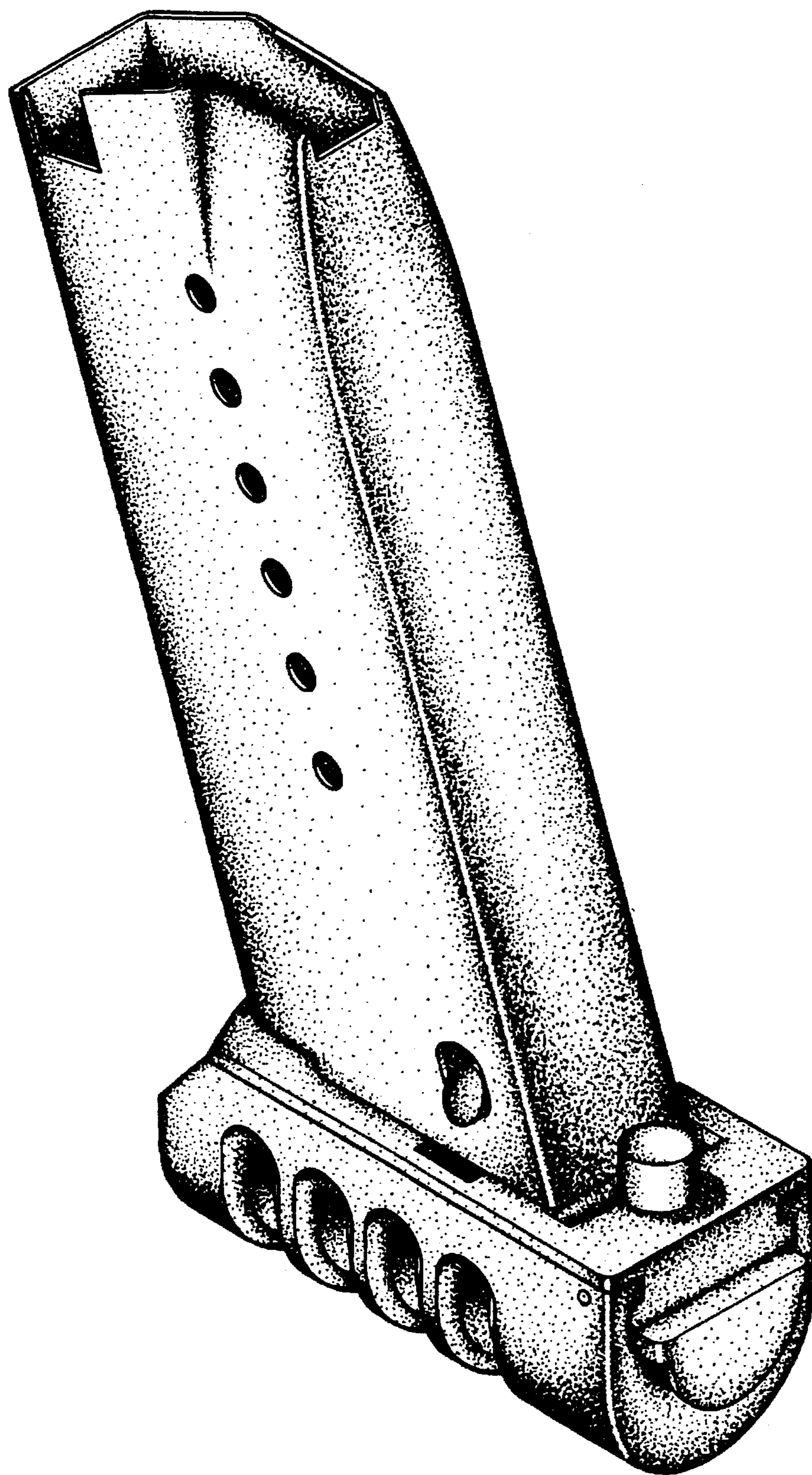

fig. 1

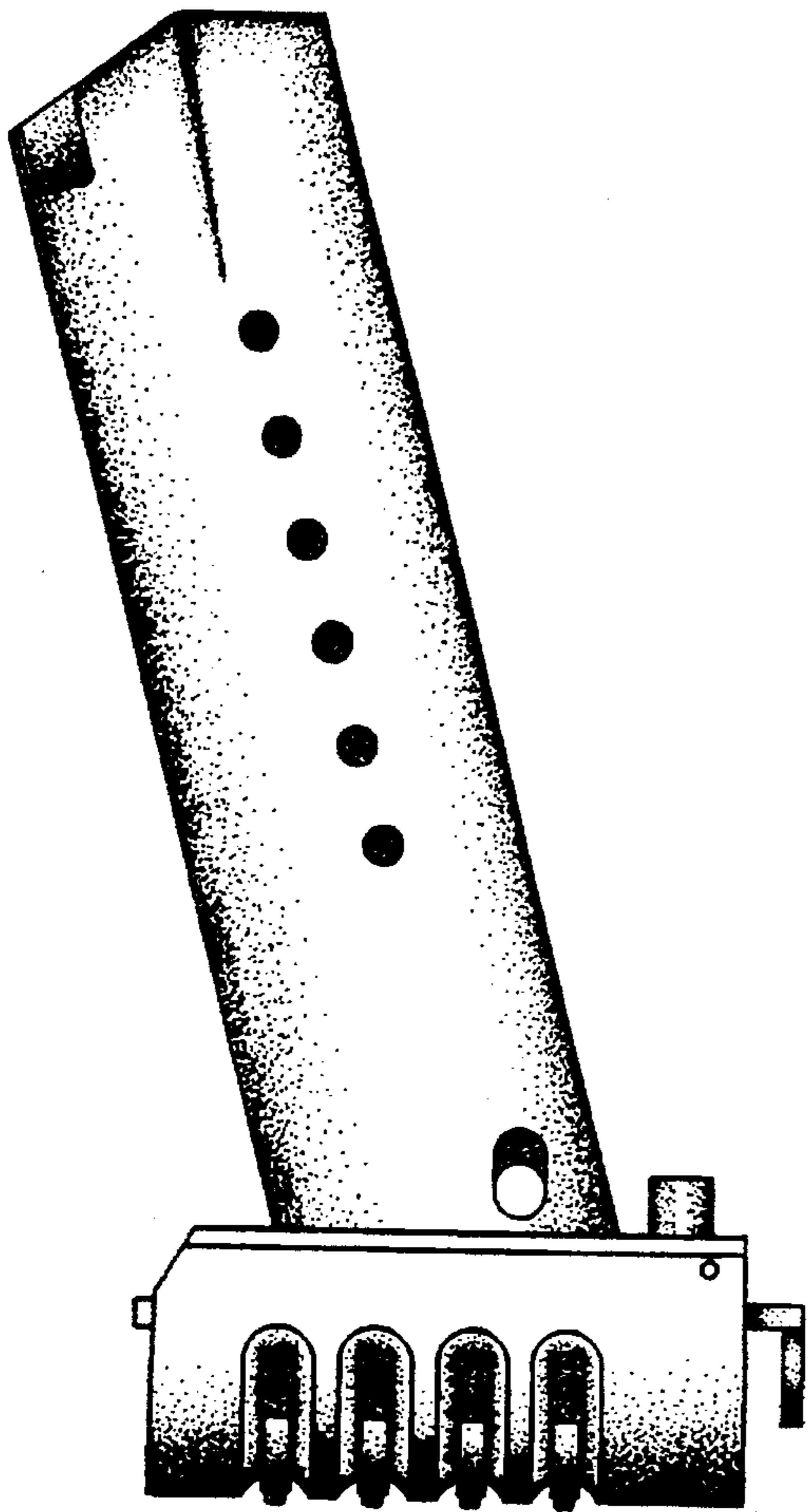

fig. 2

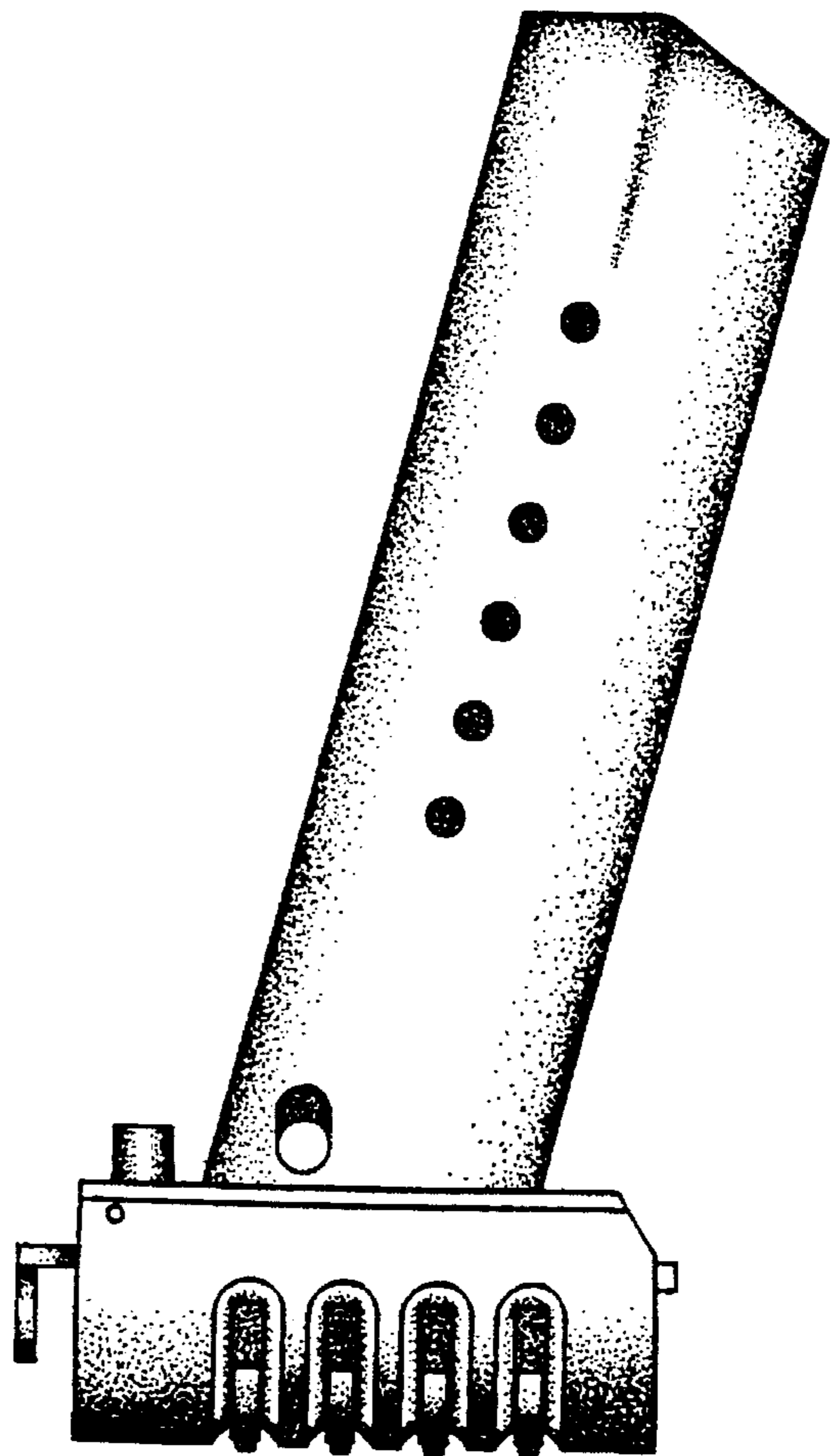

fig. 3

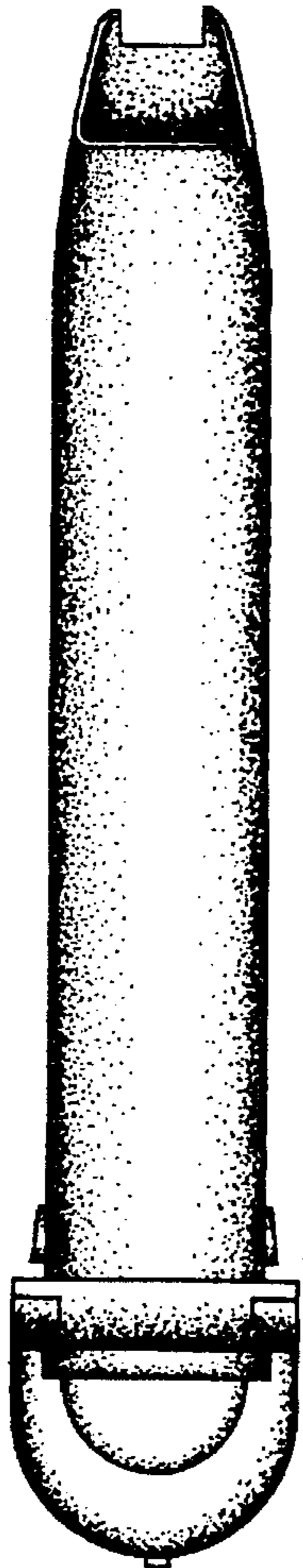

fig. 6

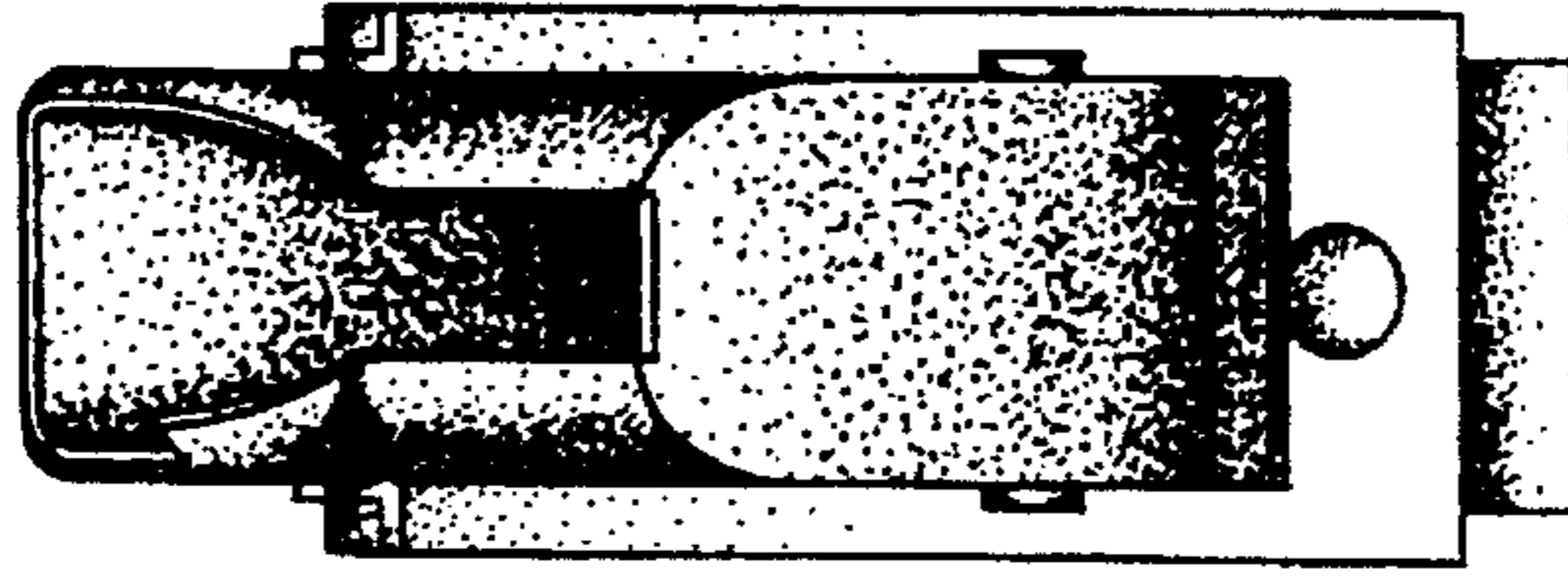

fig. 4

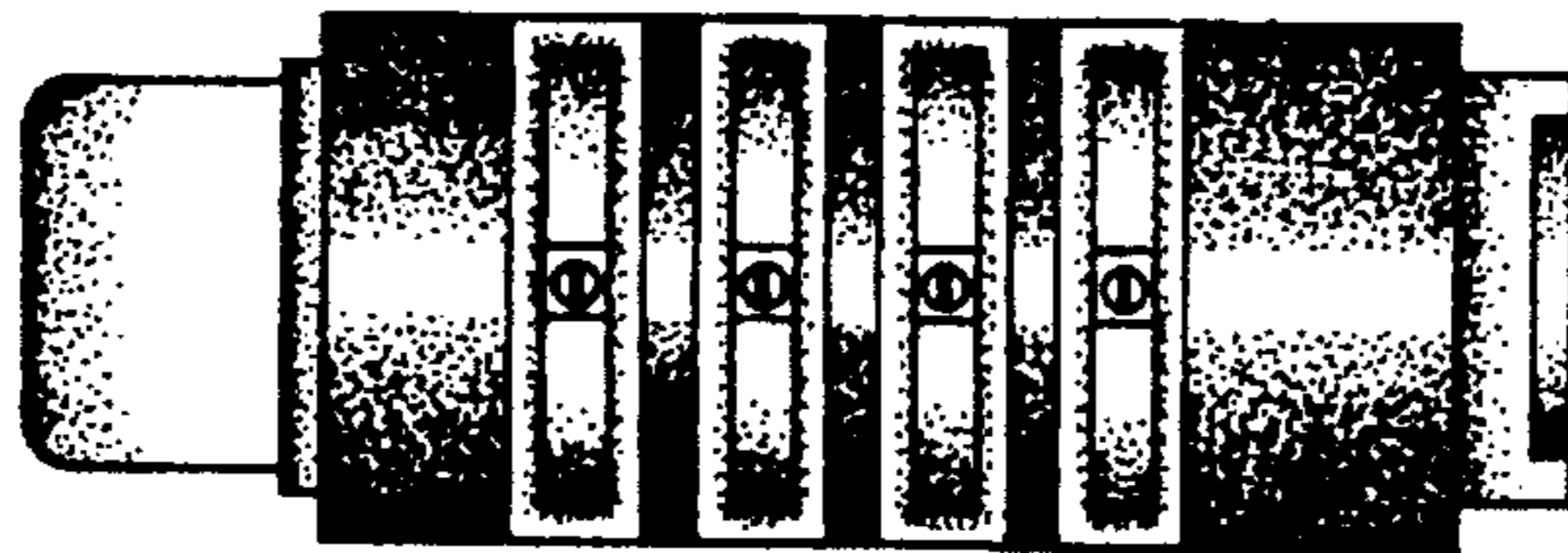

fig. 5

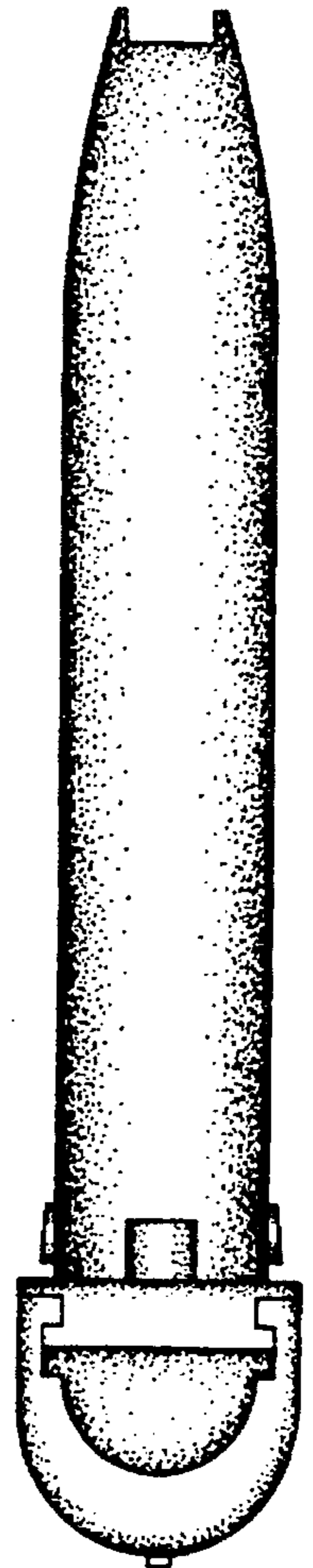

fig. 7

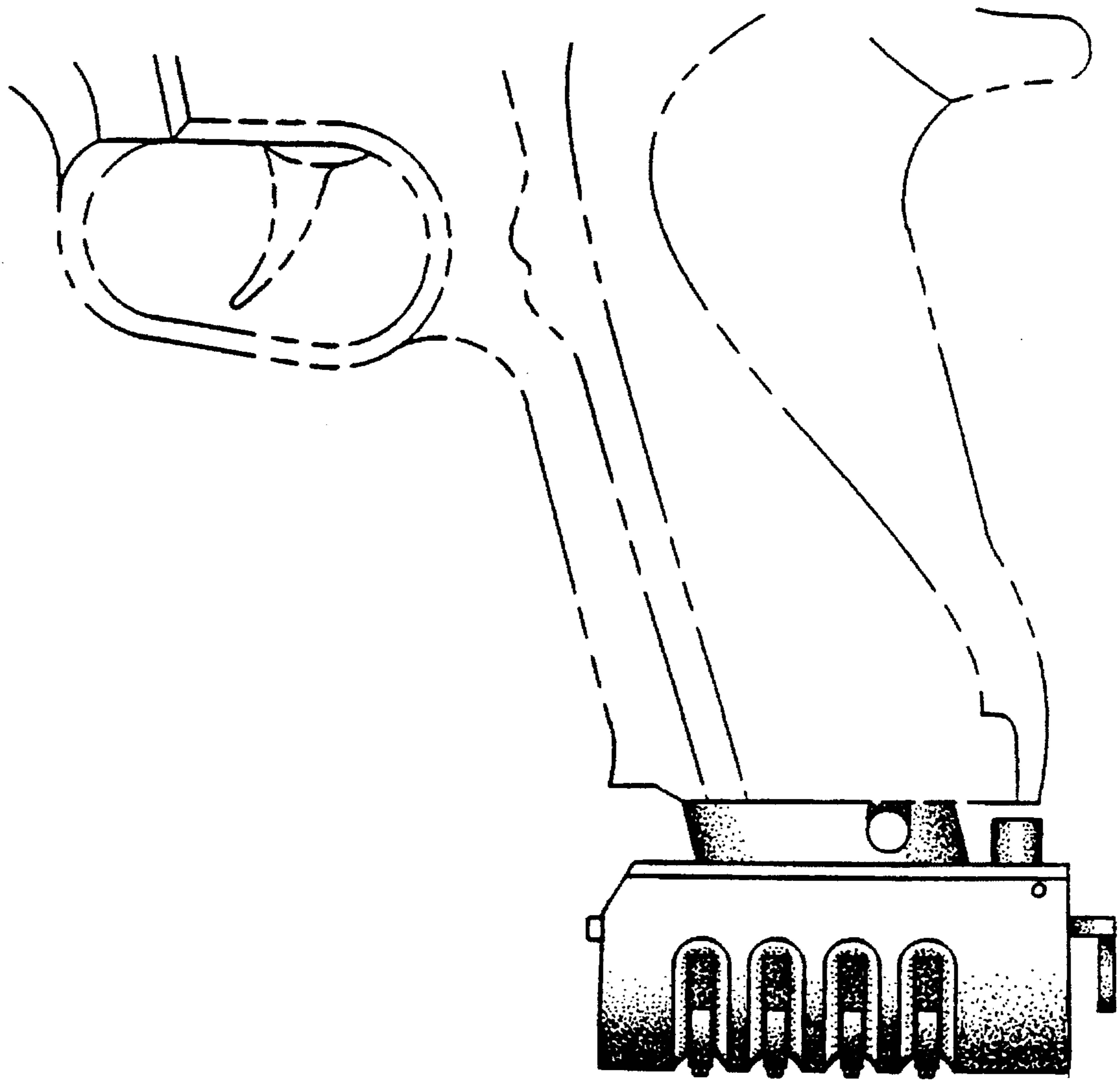

fig. 8