



US00D376145S

United States Patent [19]

Hathorn et al.

[11] Patent Number: **Des. 376,145**

[45] Date of Patent: ****Dec. 3, 1996**

[54] TELEPHONE TEST SET

[75] Inventors: **Linda L. Hathorn**, Camarillo; **Edward J. Zoiss**, Moorpark, both of Calif.

[73] Assignee: **Harris Corporation**, Melbourne, Fla.

[**] Term: **14 Years**

[21] Appl. No.: **50,200**

[22] Filed: **Feb. 12, 1996**

[52] U.S. Cl. **D14/147; D10/78; D14/240**

[58] Field of Search D14/137, 138, D14/140, 142, 147, 148, 240, 248; 379/29, 419, 420, 428, 440, 433, 434, 429; D10/75, 78; 455/89, 90

[56] **References Cited**

U.S. PATENT DOCUMENTS

D. 258,061	1/1981	Foreman	D14/147
D. 280,504	9/1985	Walker, Jr.	D14/147
D. 295,411	4/1988	Cho et al.	D14/248 X
D. 338,890	8/1993	Nogas et al.	D14/248
2,420,638	5/1947	Hellmann	379/433 X

4,153,822	5/1979	Ueda et al.	D14/248 X
5,332,322	7/1994	Gambaro	379/433 X
5,513,259	4/1996	Pettit	379/433 X

OTHER PUBLICATIONS

Telephony May 11, 1987, p. 97, Harris Telephone Test Set in upper left corner.

Primary Examiner—Jeffrey Asch
Attorney, Agent, or Firm—Harry M. Fleck

[57] **CLAIM**

The ornamental design for telephone test set, as shown.

DESCRIPTION

FIG. 1 is a top and right side perspective view of the telephone test set, showing our new design; FIG. 2 is a bottom and left side perspective view looking at the bottom and left side; FIG. 3 is a bottom plan view; FIG. 4 is an elevational view of the left side; and, FIG. 5 is a top plan view.

1 Claim, 2 Drawing Sheets

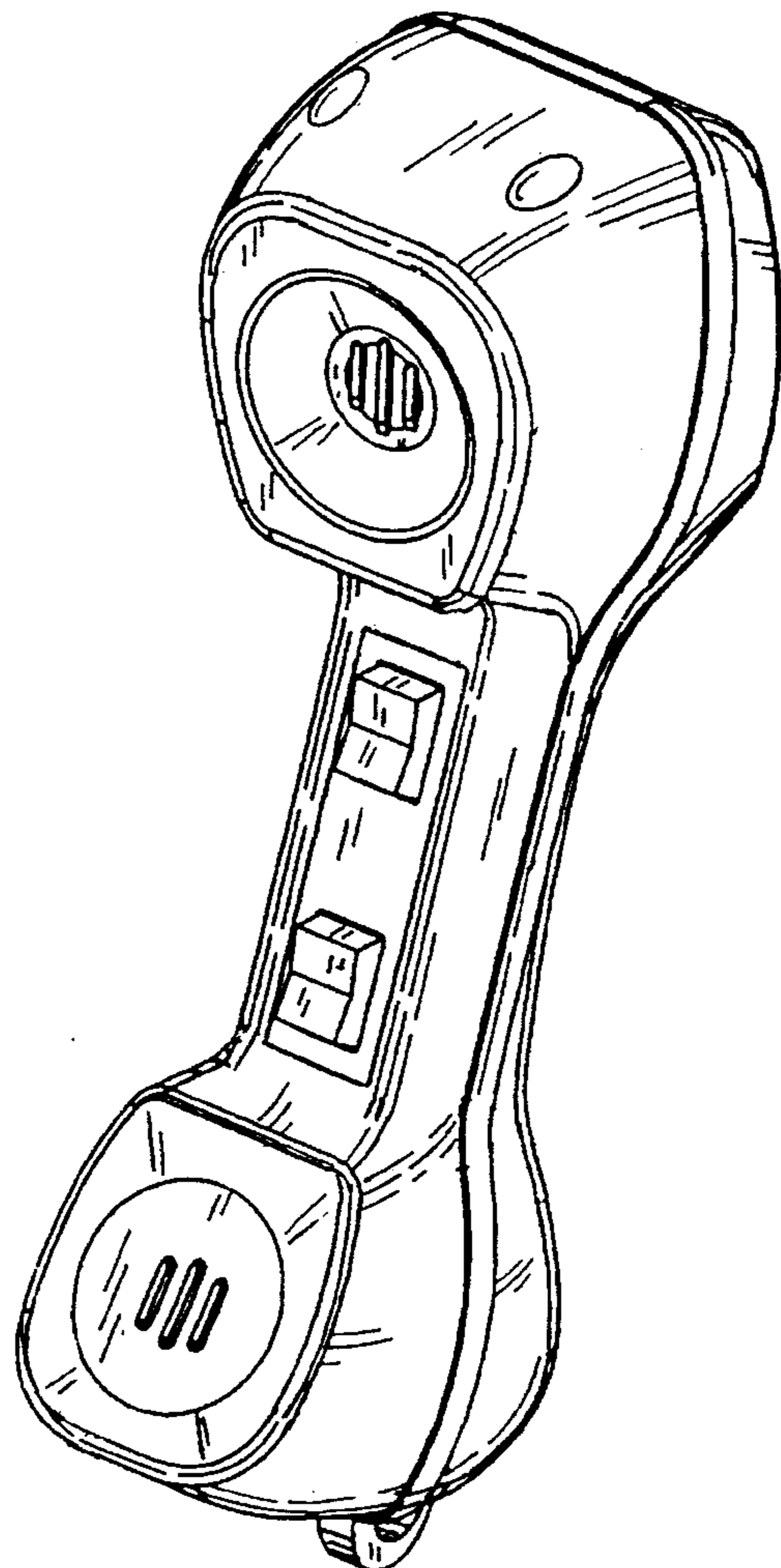
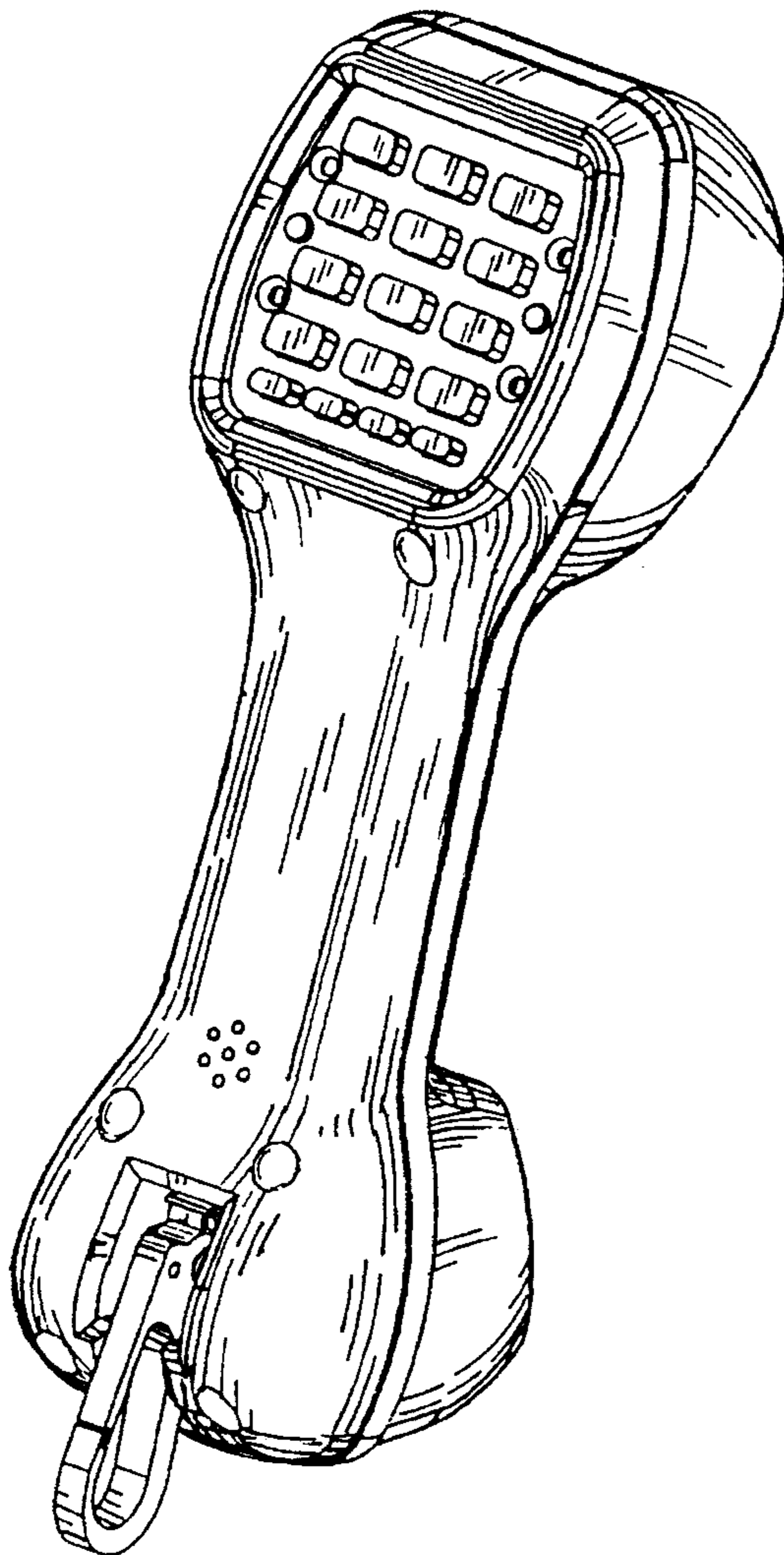

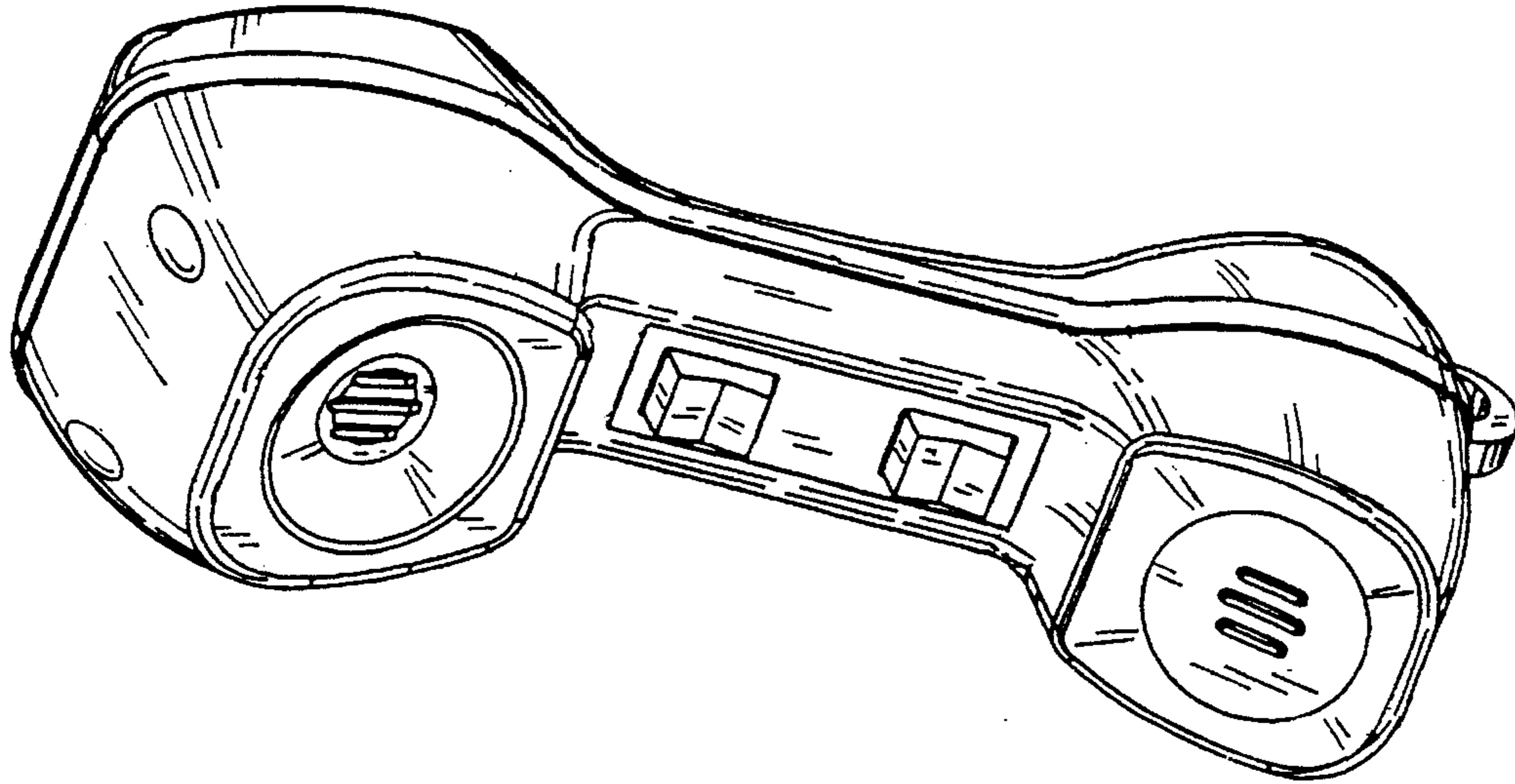

FIG. 2

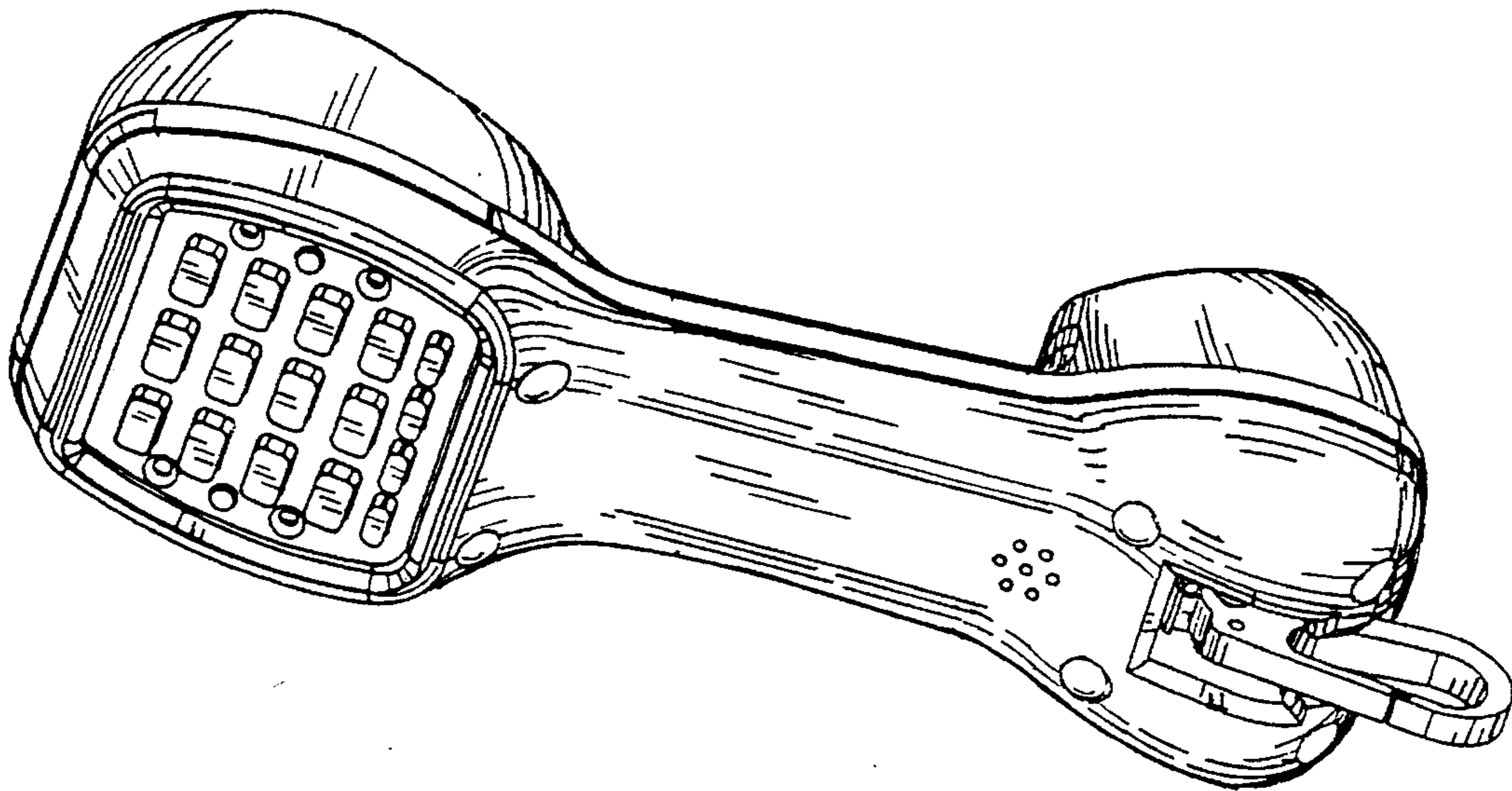

FIG. 1

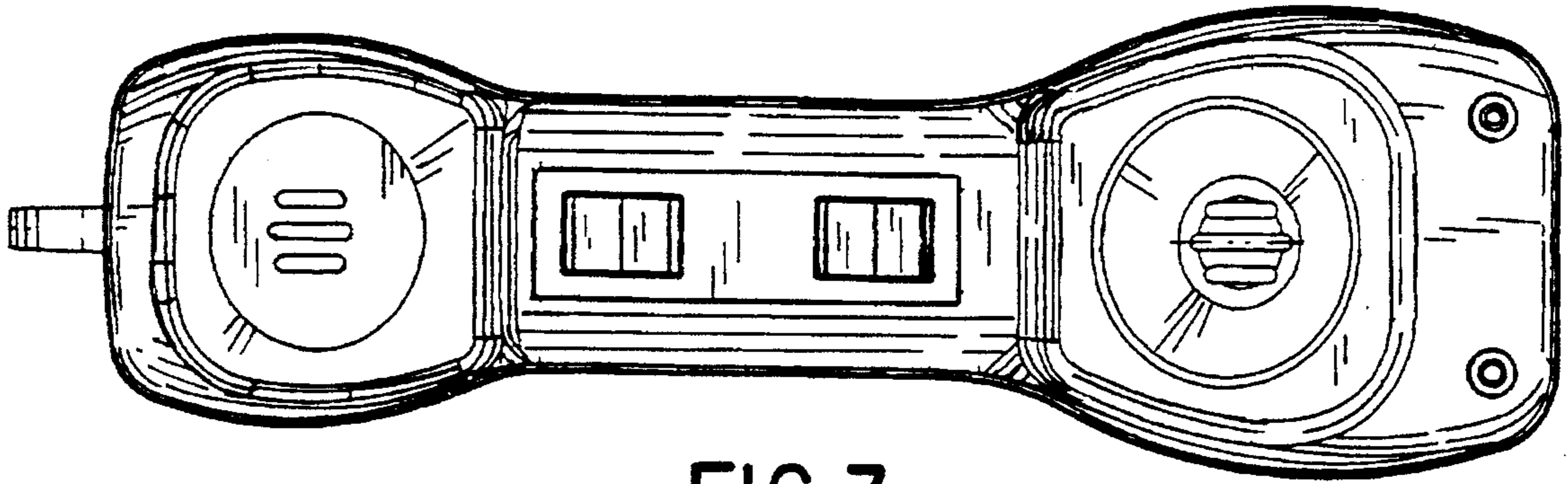

FIG. 3

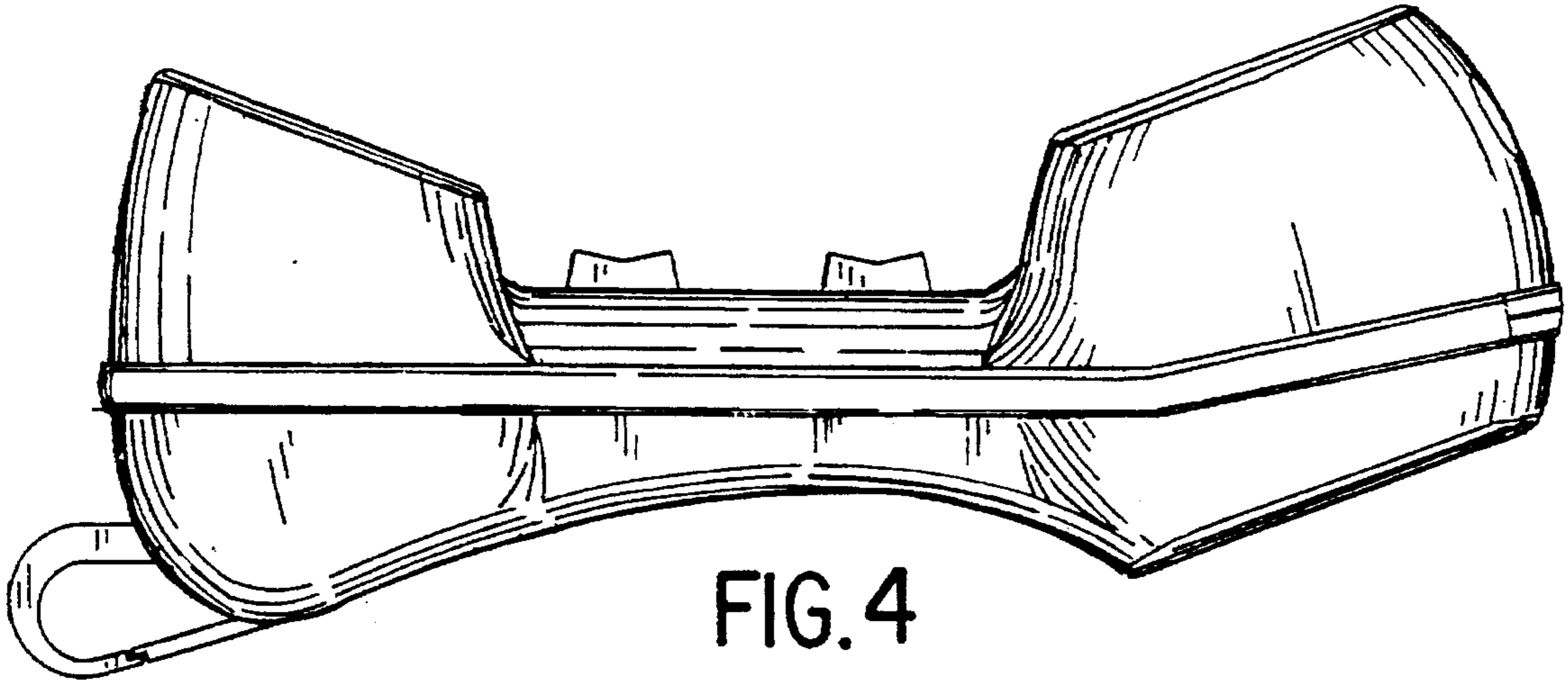

FIG. 4

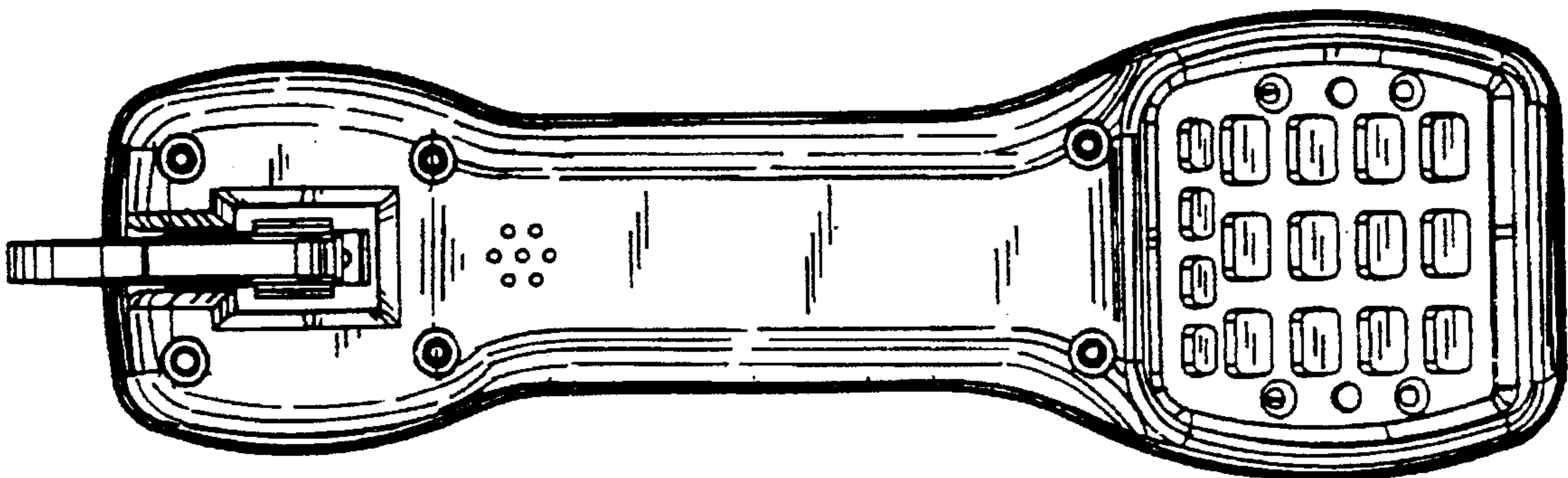

FIG. 5