



US00D376119S

United States Patent [19]

[11] Patent Number: **Des. 376,119**

Rozenwasser

[45] Date of Patent: ****Dec. 3, 1996**

[54] **JEWELRY CHAIN**

[76] Inventor: **David Rozenwasser**, 26 Har Dafna Street, Savion, Israel

[**] Term: **14 Years**

[21] Appl. No.: **28,960**

[22] Filed: **Sep. 27, 1994**

[30] **Foreign Application Priority Data**

Mar. 29, 1994 [IL] Israel 22462

[52] **U.S. Cl.** **D11/13**

[58] **Field of Search** D11/1-18, 93-94, D11/86, 54; 59/78, 80, 82-84, 90, 92; 63/1.1-2, 3-11

[56] **References Cited**

U.S. PATENT DOCUMENTS

D. 321,148	10/1991	Chiaramonti	D11/93
D. 340,422	10/1993	Grando	D11/93
D. 343,136	1/1994	Grando	D11/12
D. 343,806	2/1994	Bedoyan	D11/13

Primary Examiner—Ralf Seifert
Attorney, Agent, or Firm—Helfgott & Karas, P.C.

[57] **CLAIM**

The ornamental design for a jewelry chain, as shown and described.

DESCRIPTION

FIG. 1 is a front elevational view of a jewelry chain showing my new design;
FIG. 2 is a side elevational view;
FIG. 3 is a perspective view of a single link that comprises the chain, the jewelry chain being omitted for ease of illustration;

FIG. 4 is a perspective view of an alternate link to that shown in FIG. 1, the chain being omitted for ease of illustration;
FIG. 5 is an end elevational view of FIG. 1;
FIG. 6 is a front elevational view of a jewelry chain showing a second embodiment of my new design;
FIG. 7 is a side elevational view of FIG. 6;
FIG. 8 is a perspective view of a single link that comprises the chain of FIG. 6, the jewelry chain being omitted for ease of illustration;
FIG. 9 is a perspective view of an alternate link to that shown in FIG. 6, the chain being omitted for ease of illustration;
FIG. 10 is an end elevational view of FIG. 6;
FIG. 11 is a front elevational view of a jewelry chain showing a third embodiment of my new design;
FIG. 12 is a side elevational view of FIG. 11;
FIG. 13 is a perspective view of a single link that comprises the chain of FIG. 11, the jewelry chain being omitted for ease of illustration;
FIG. 14 is a perspective view of an alternate link to that shown in FIG. 11, the chain being omitted for ease of illustration;
FIG. 15 is an end elevational view of FIG. 11;
FIG. 16 is a front elevational view of a jewelry chain showing a fourth embodiment of my new design;
FIG. 17 is a side elevational view of FIG. 16;
FIG. 18 is a perspective view of a single link that comprises the chain of FIG. 16, the jewelry chain being omitted for ease of illustration;
FIG. 19 is a perspective view of an alternate link to that shown in FIG. 16, the chain being omitted for ease of illustration; and,
FIG. 20 is an end elevational view of FIG. 16.

1 Claim, 4 Drawing Sheets

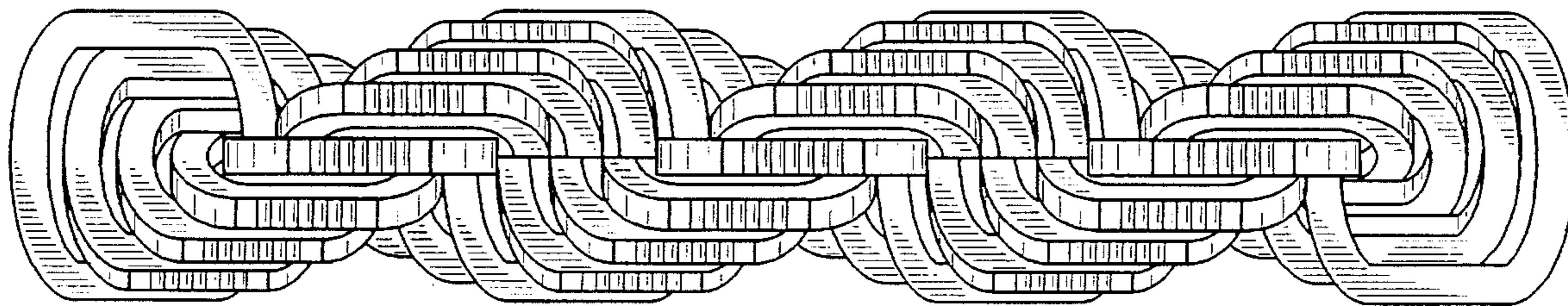

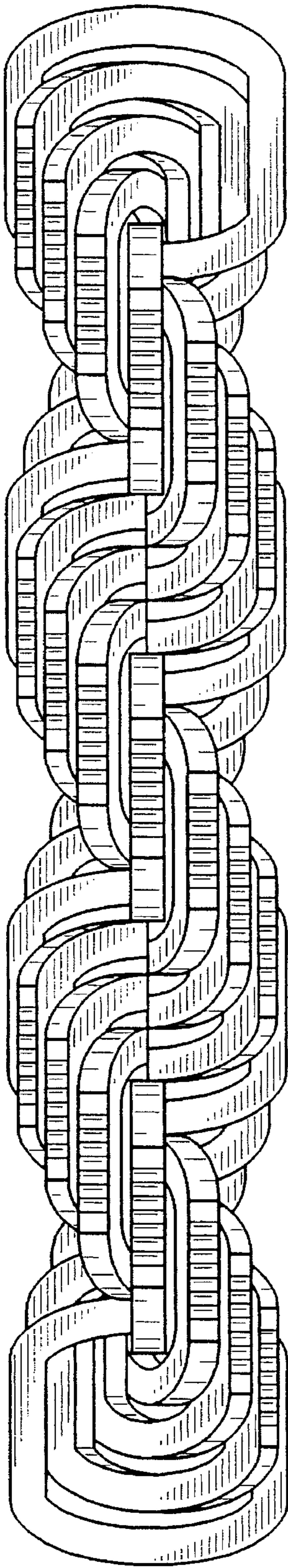

FIG. 1

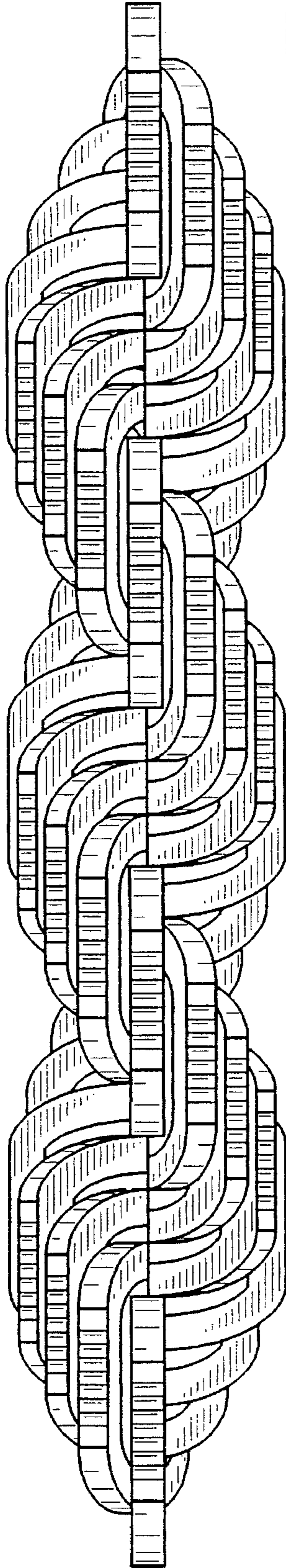

FIG. 2

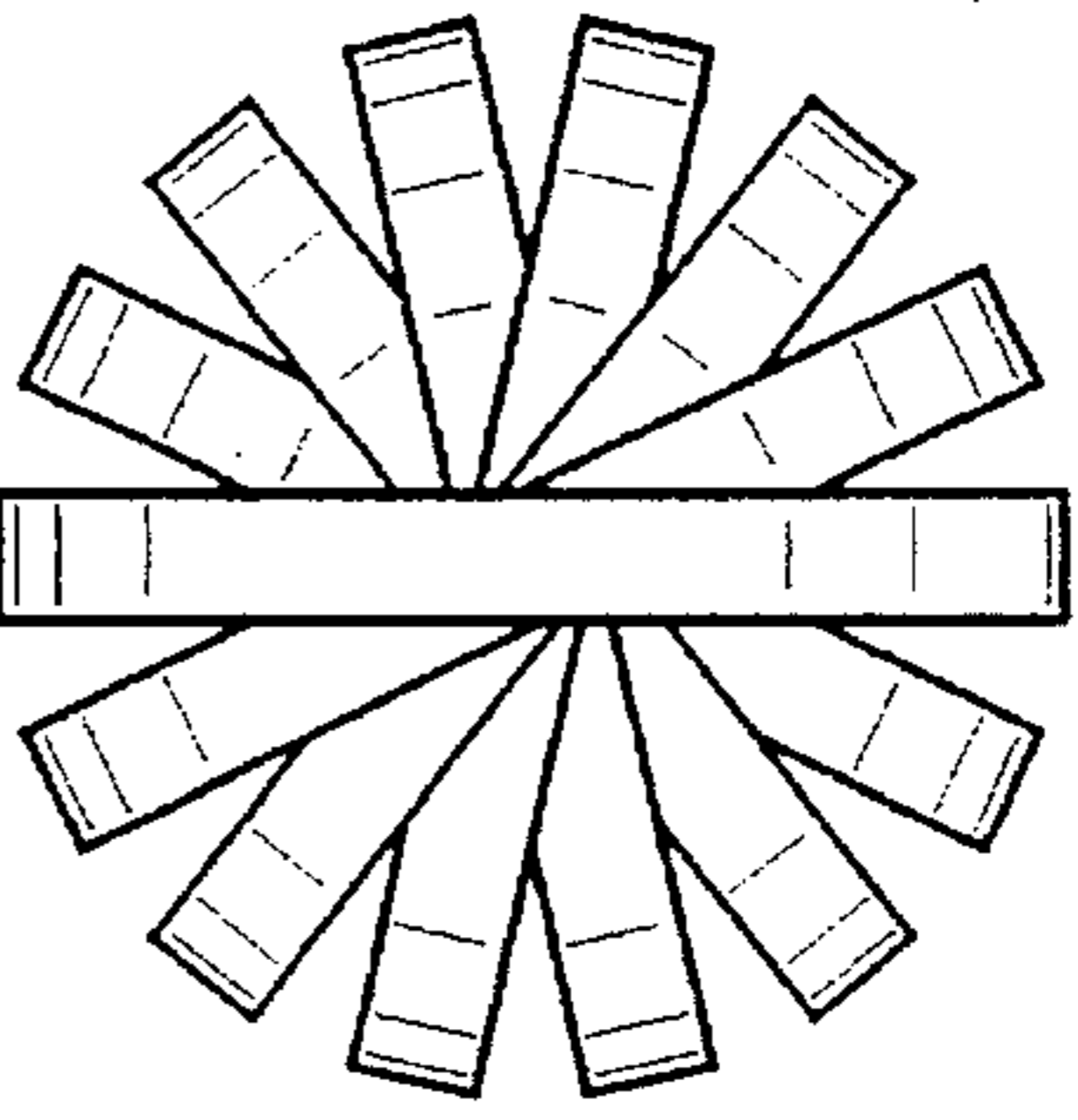

FIG. 5

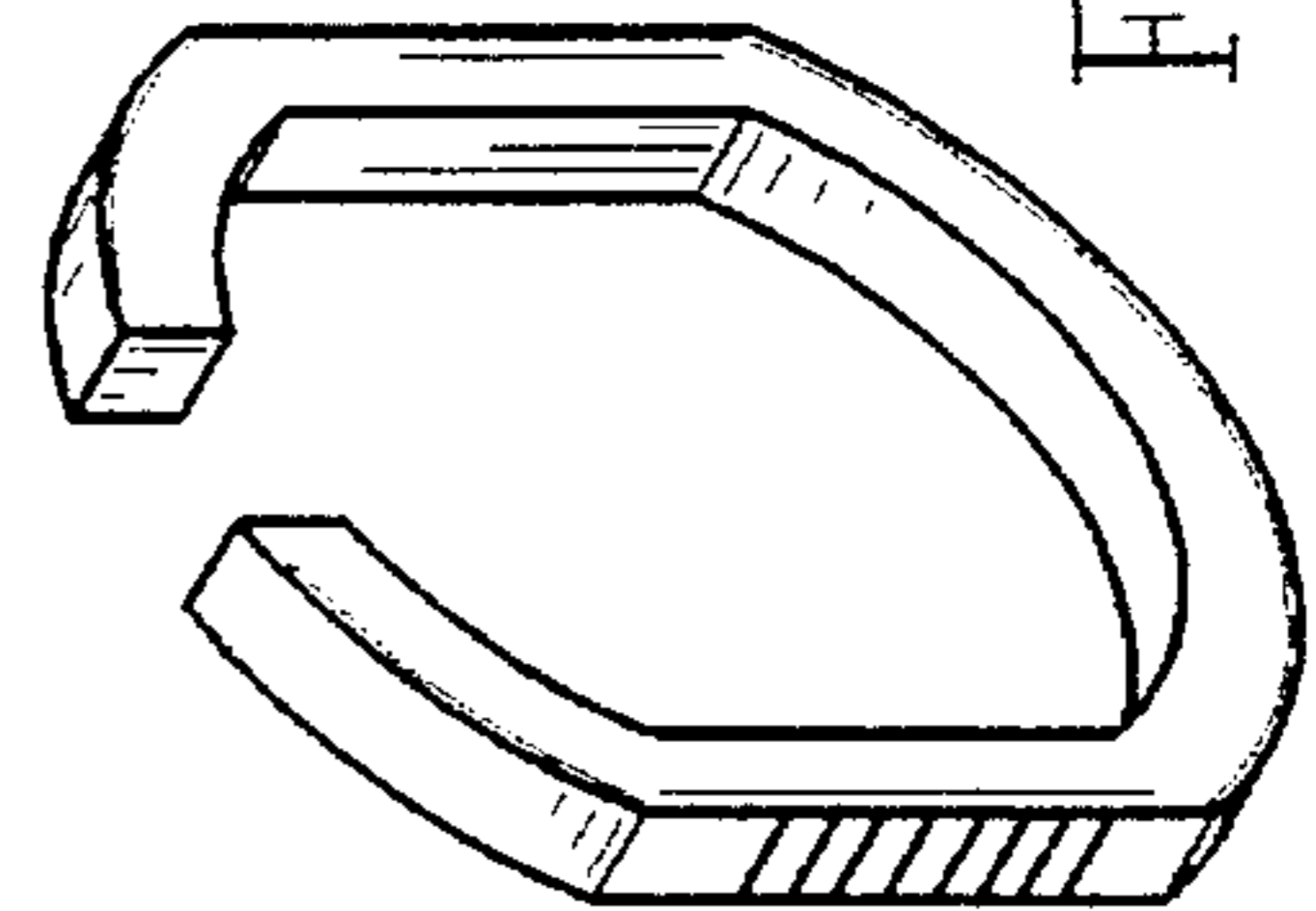

FIG. 4

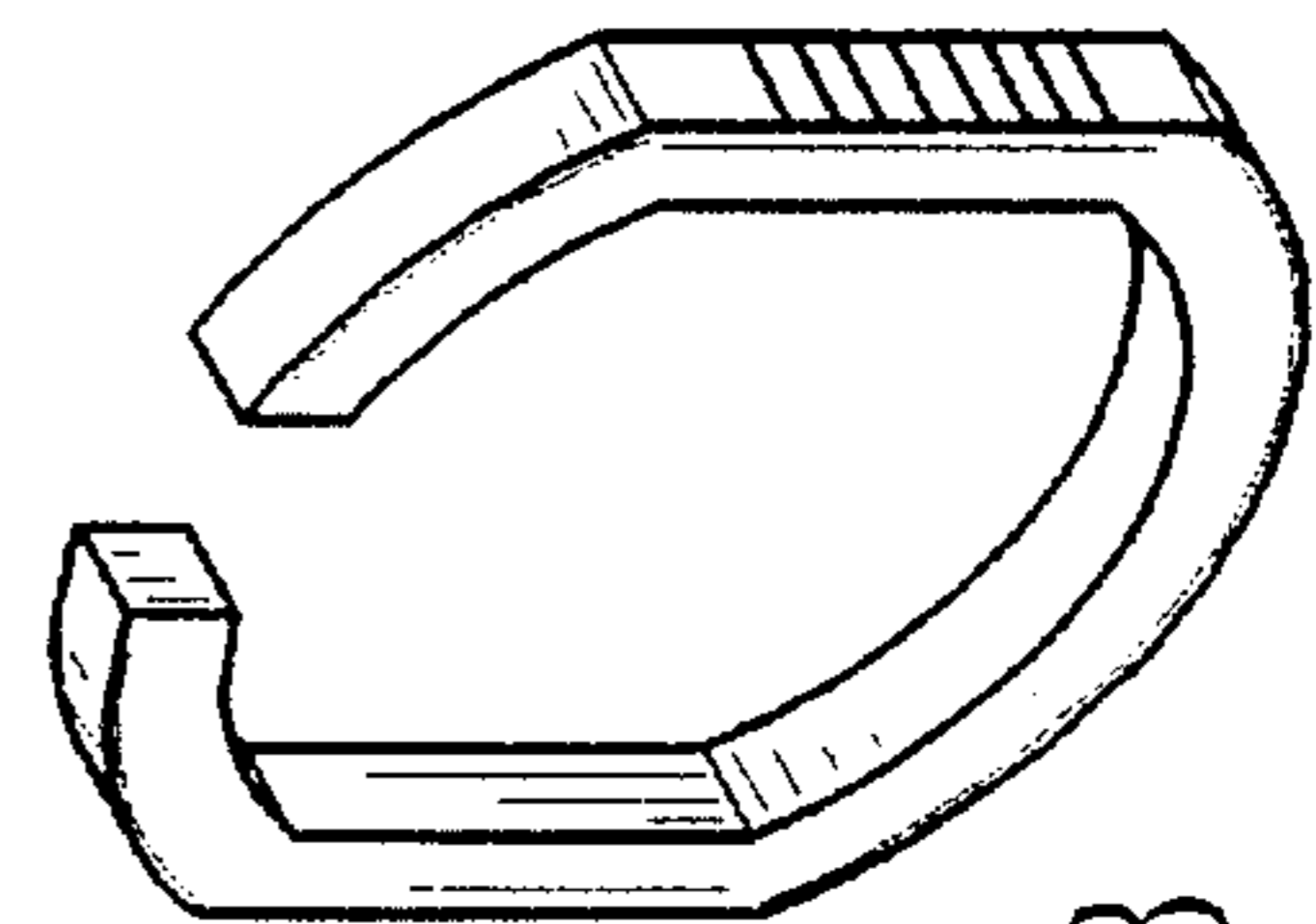

FIG. 3

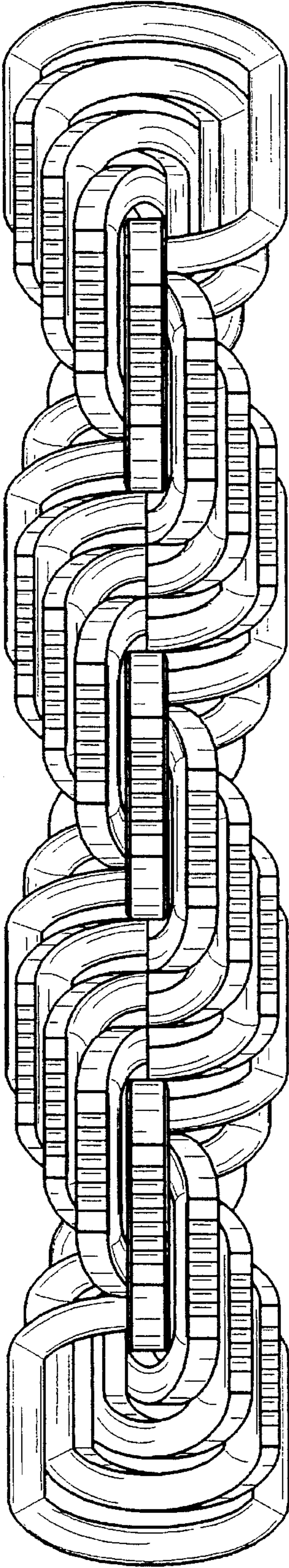

FIG. 6

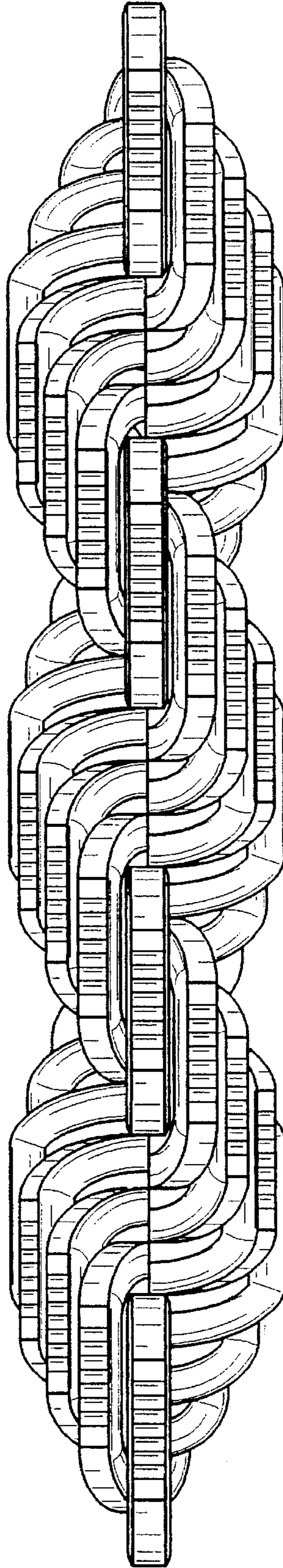

FIG. 7

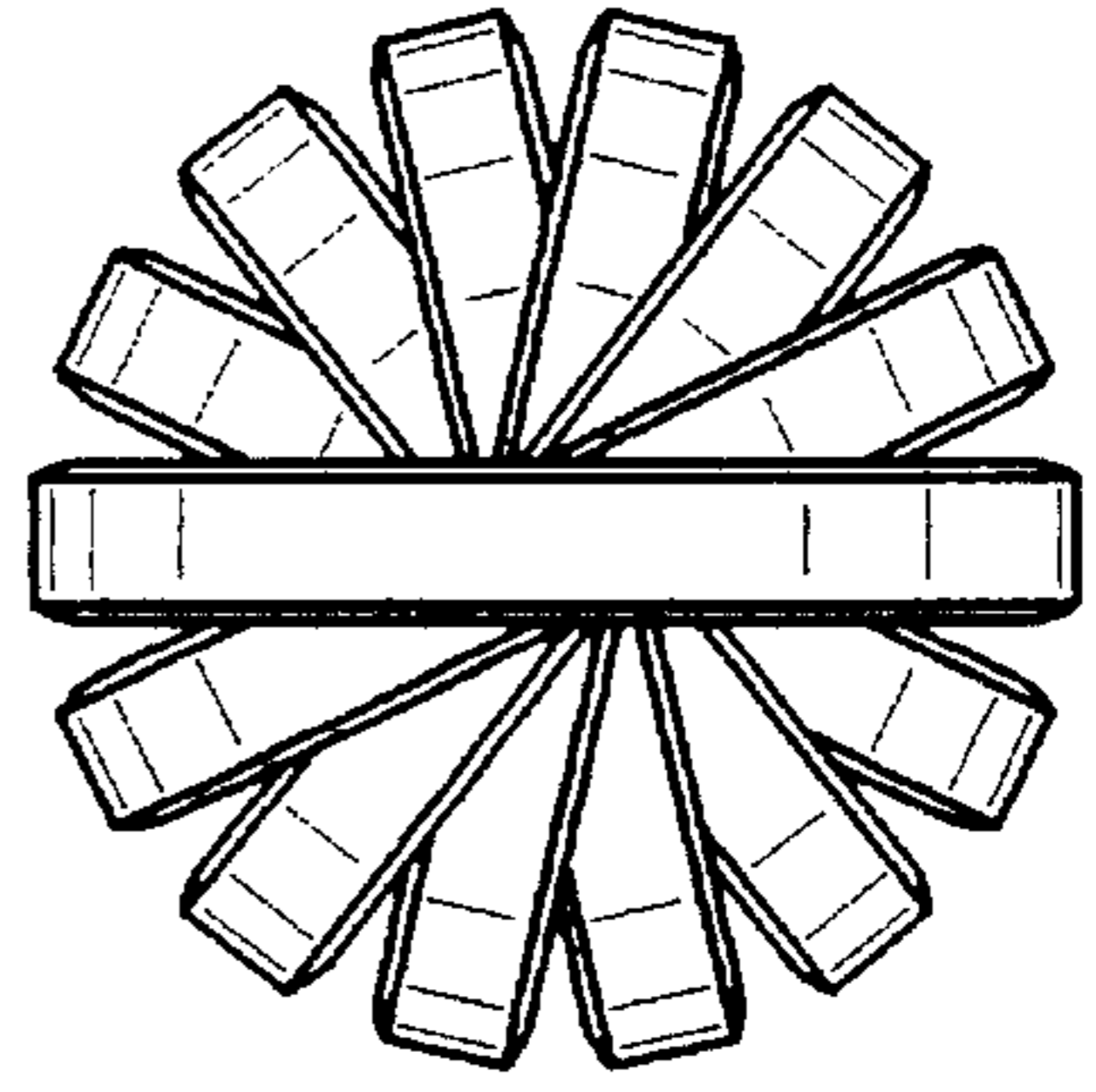

FIG. 10

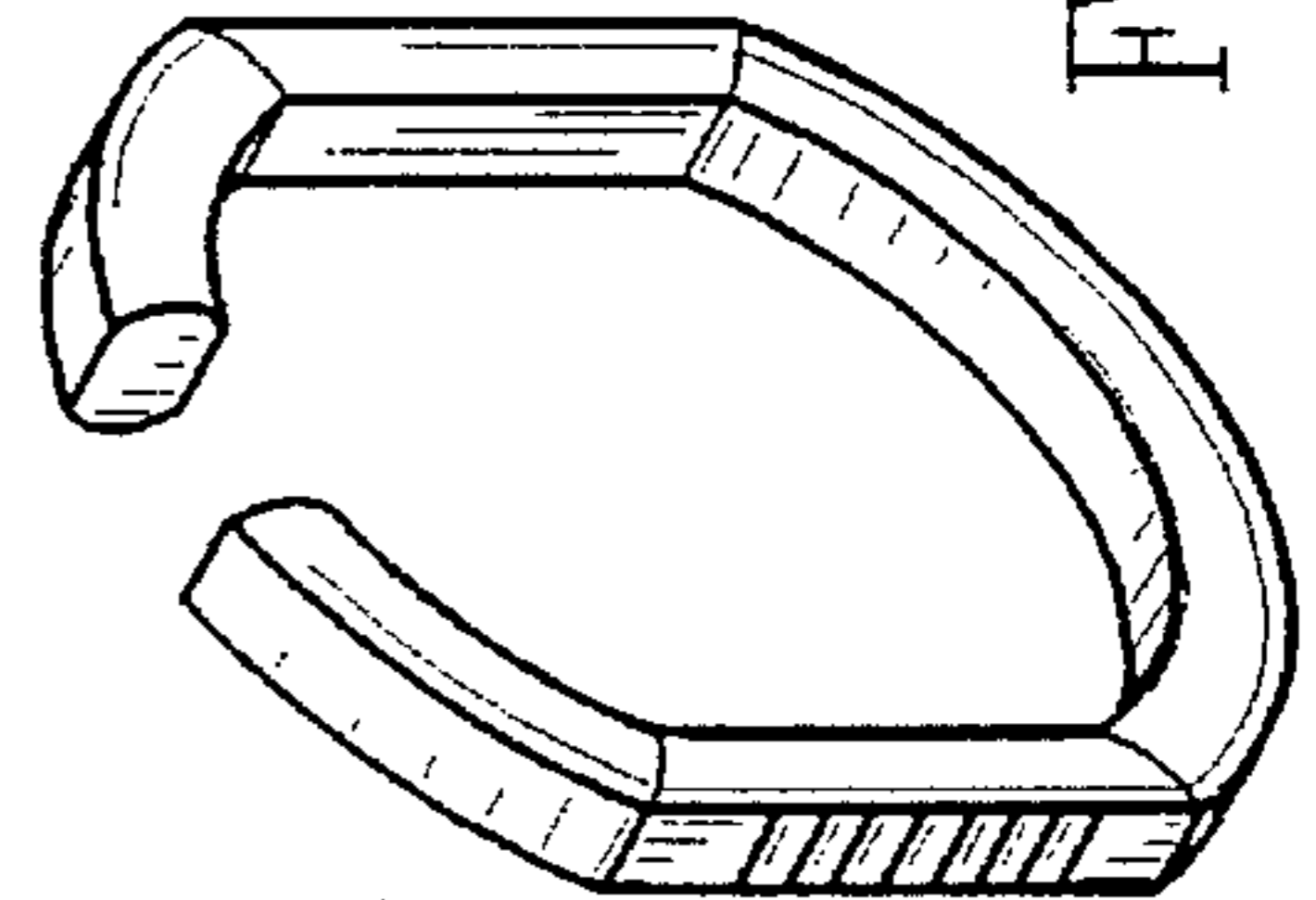

FIG. 9

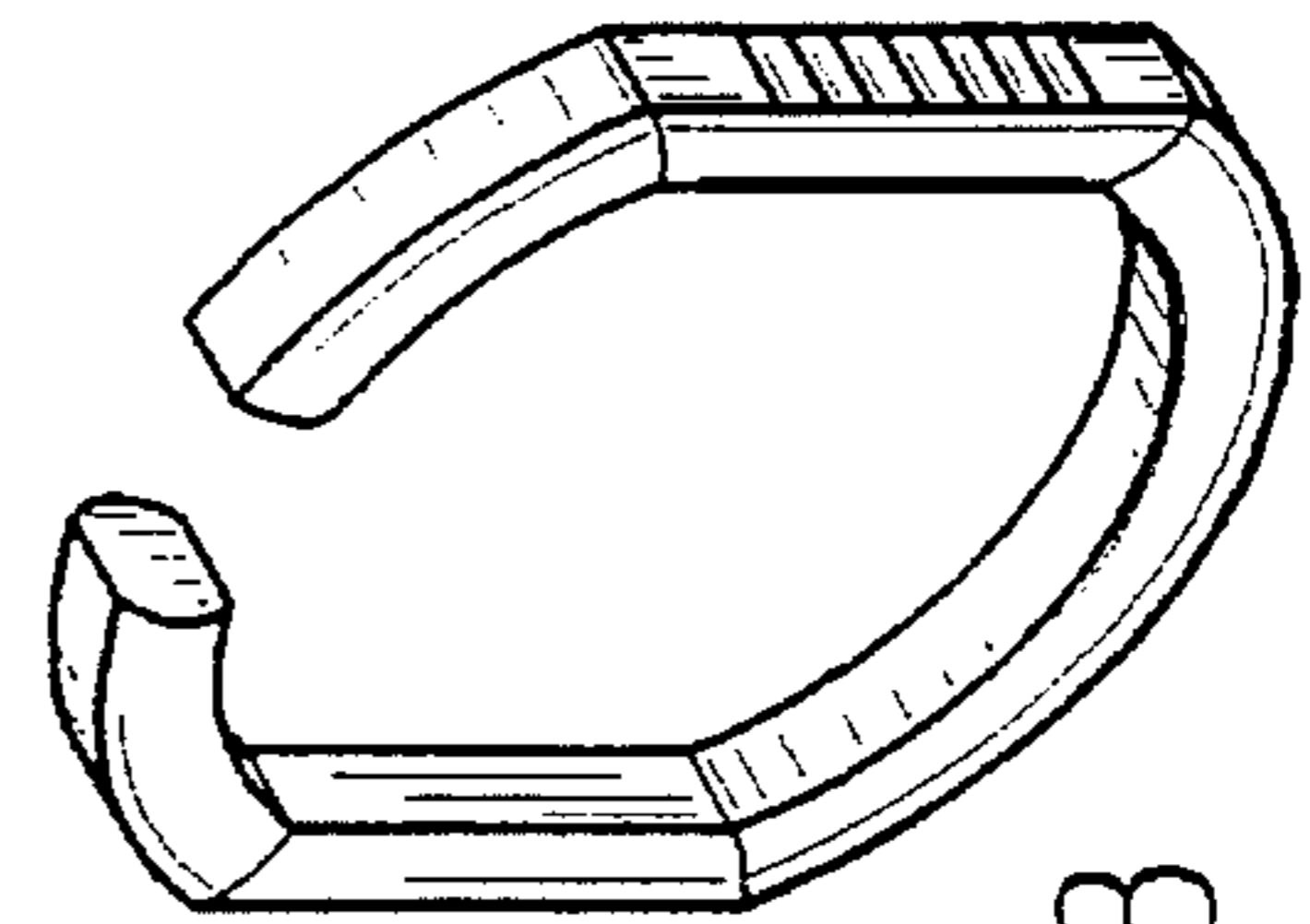

FIG. 8

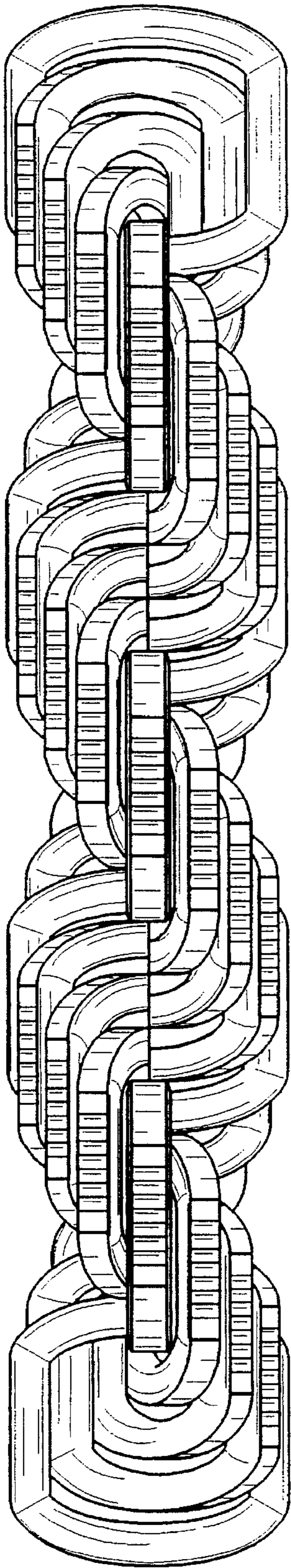

FIG. 11

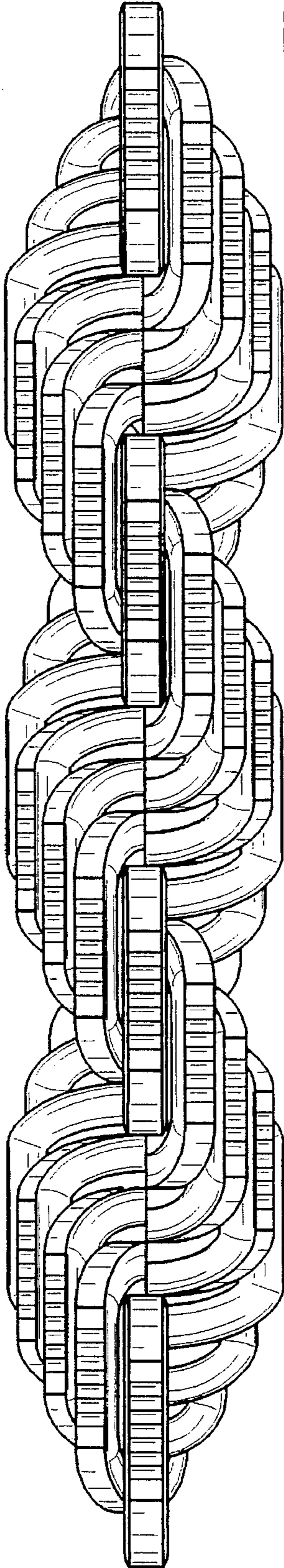

FIG. 12

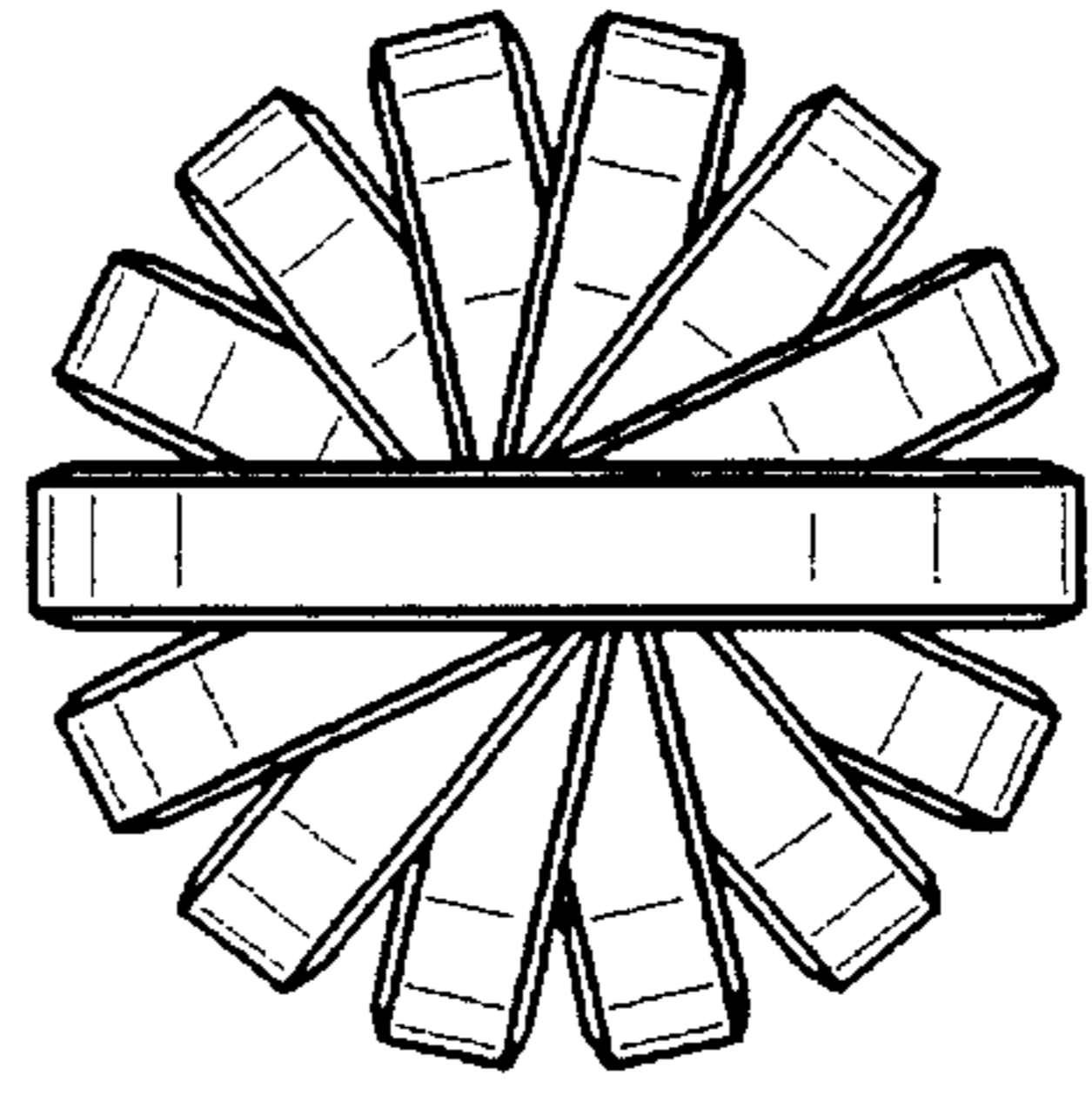

FIG. 15

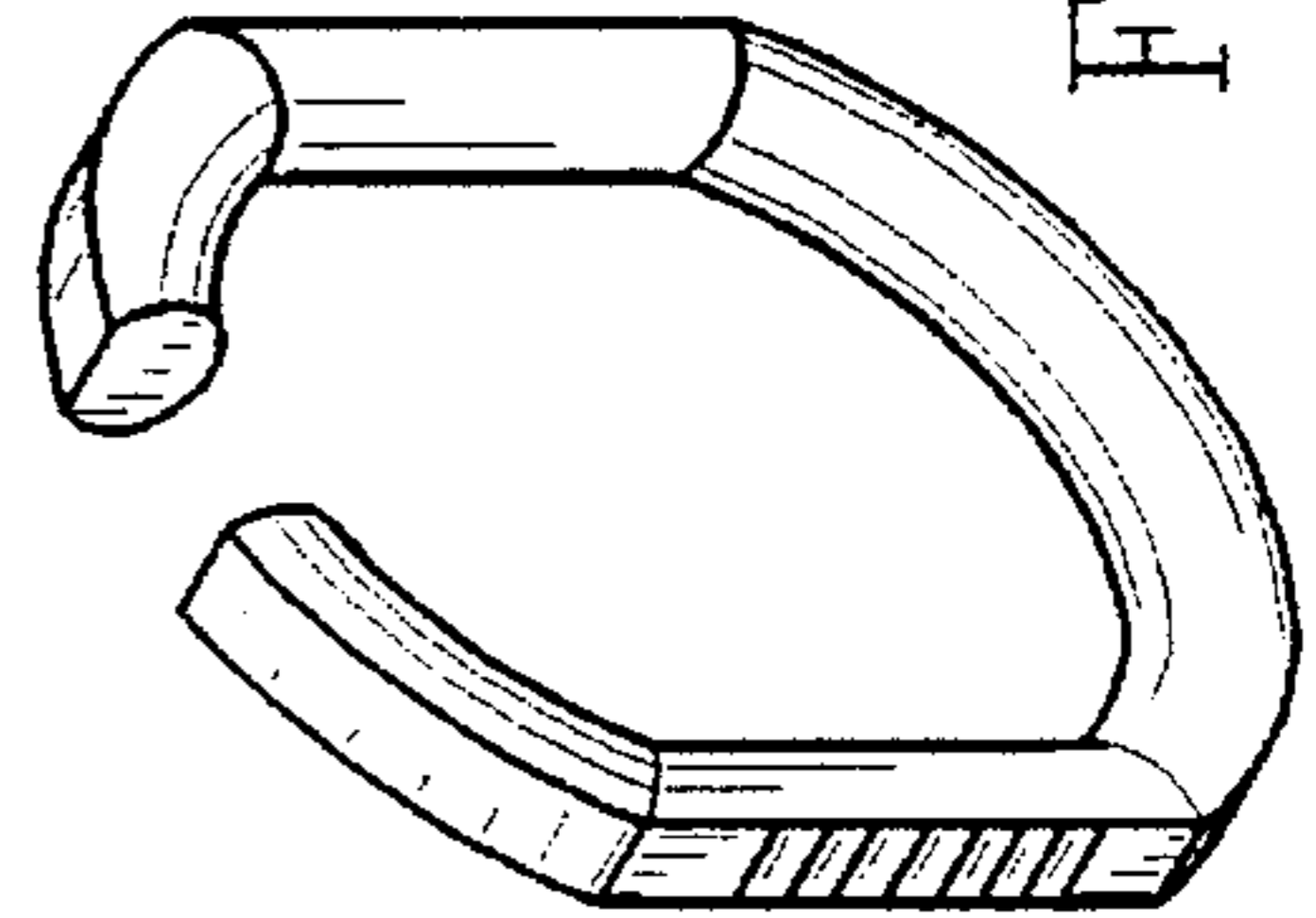

FIG. 14

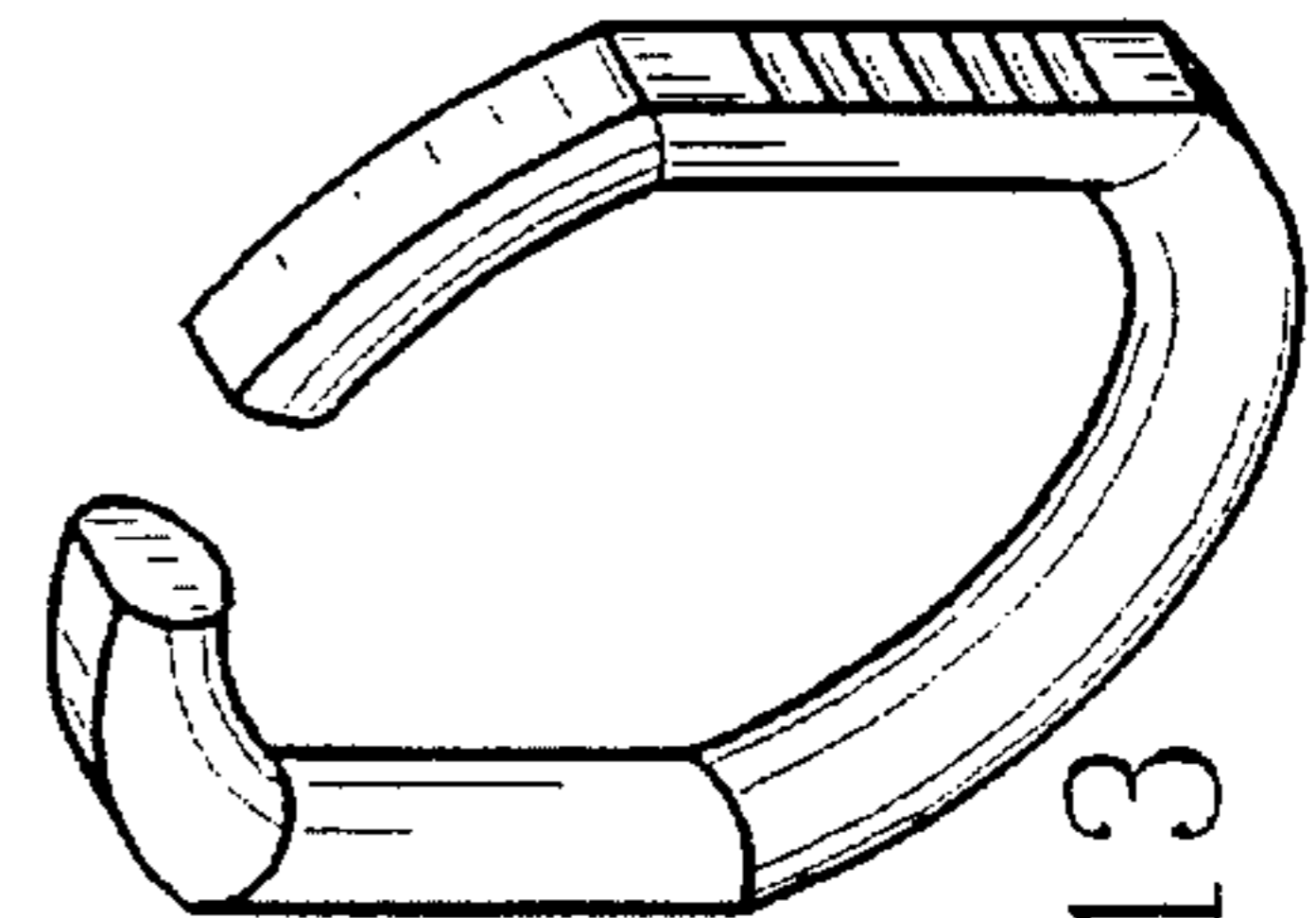

FIG. 13

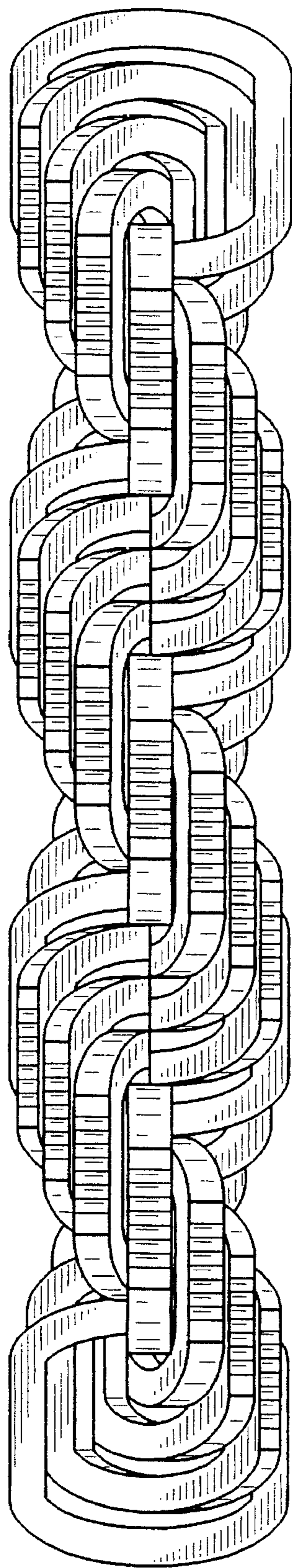

FIG. 16

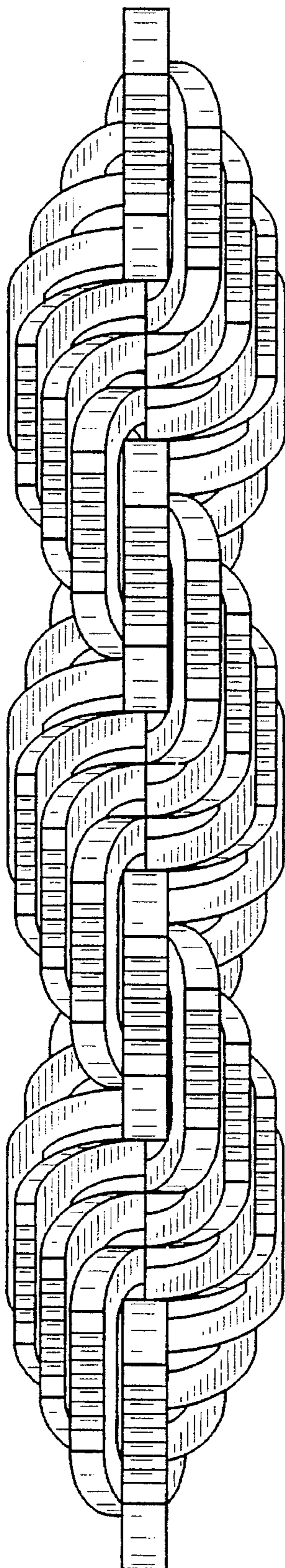

FIG. 17

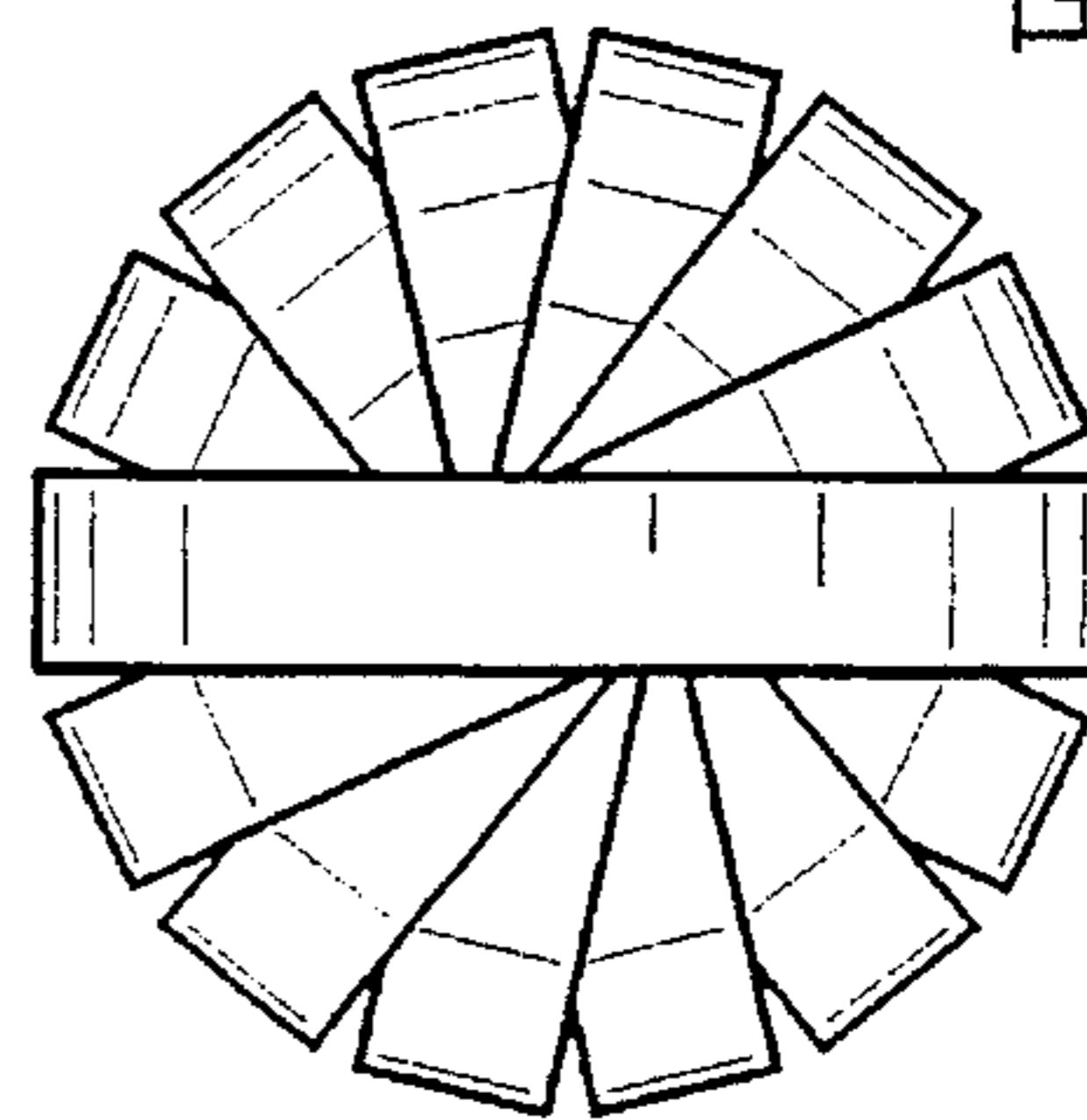

FIG. 20

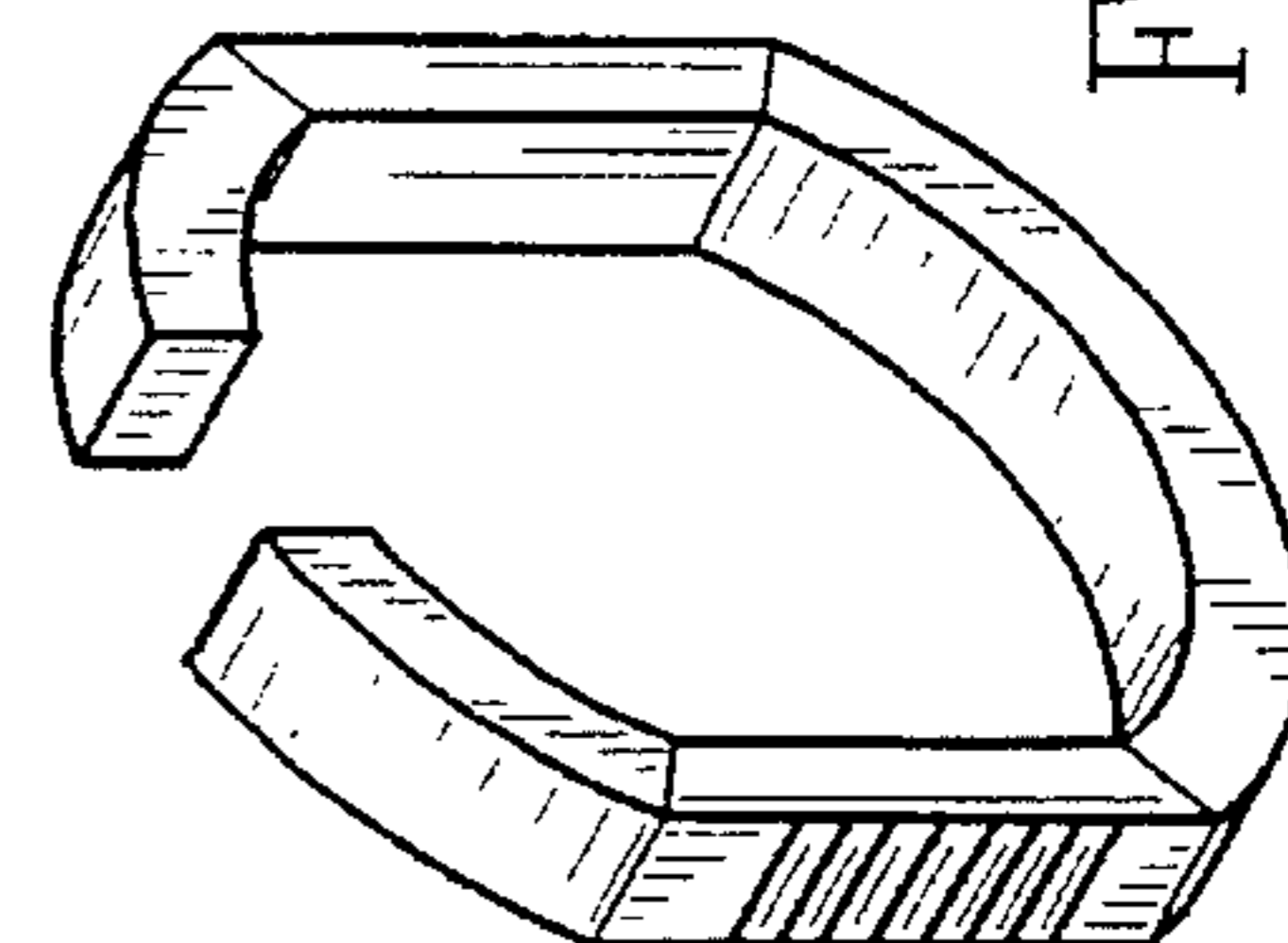

FIG. 19

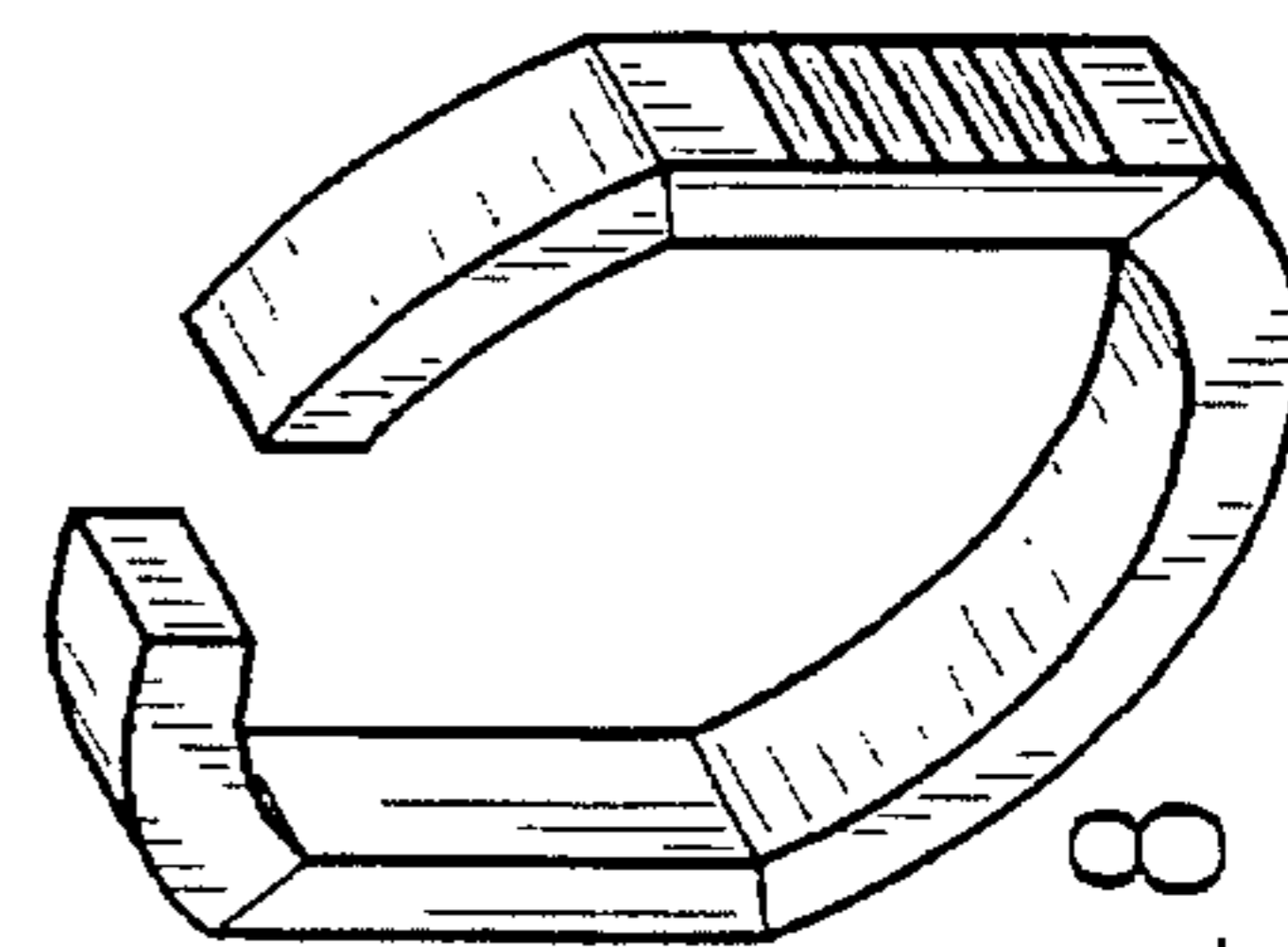

FIG. 18