



US00D376096S

United States Patent [19]

[11] Patent Number: **Des. 376,096**

Tisbo et al.

[45] Date of Patent: ****Dec. 3, 1996**

[54] **STACKABLE HOSE REEL WITH TRAY**

5,046,520 9/1991 Sanchez, Jr. et al. 242/403.1

[75] Inventors: **Thomas A. Tisbo**, Barrington Hills;
Stephen P. Whitehead, Elgin; **Brian Moon**, Sycamore, all of Ill.

Primary Examiner—Kay H. Chin
Attorney, Agent, or Firm—McHale & Slavin, P.A.

[73] Assignee: **Suncast Corporation**, Batavia, Ill.

[57] **CLAIM**

[**] Term: **14 Years**

The ornamental design for a stackable hose reel with tray, as shown and described.

[21] Appl. No.: **42,495**

DESCRIPTION

[22] Filed: **Aug. 11, 1995**

FIG. 1 is a front plane view of the stackable hose reel with tray of the instant invention;

[52] U.S. Cl. **D8/359**; D34/24

FIG. 1A is an enlarged detail of the tray illustrated in FIG. 1;

[58] Field of Search D34/12, 24, 26;
D8/359, 358; 242/430.1

FIG. 2 is a rear view of FIG. 1;

FIG. 2A is an enlarged detail of the tray illustrated in FIG. 2;

[56] **References Cited**

U.S. PATENT DOCUMENTS

D. 323,228	1/1992	Spear et al.	D34/27
D. 323,916	2/1992	Sanchez, Jr. et al.	D34/24
D. 349,039	7/1994	Goodman et al.	D34/24
D. 352,149	11/1994	Nelson et al.	D34/24
D. 363,207	10/1995	Tisbo et al.	D8/359

FIG. 3 is a right side view thereof;

FIG. 4 is a left side view thereof;

FIG. 5 is a top view thereof;

FIG. 6 is a bottom view thereof; and,

FIG. 7 is a perspective view thereof.

1 Claim, 6 Drawing Sheets

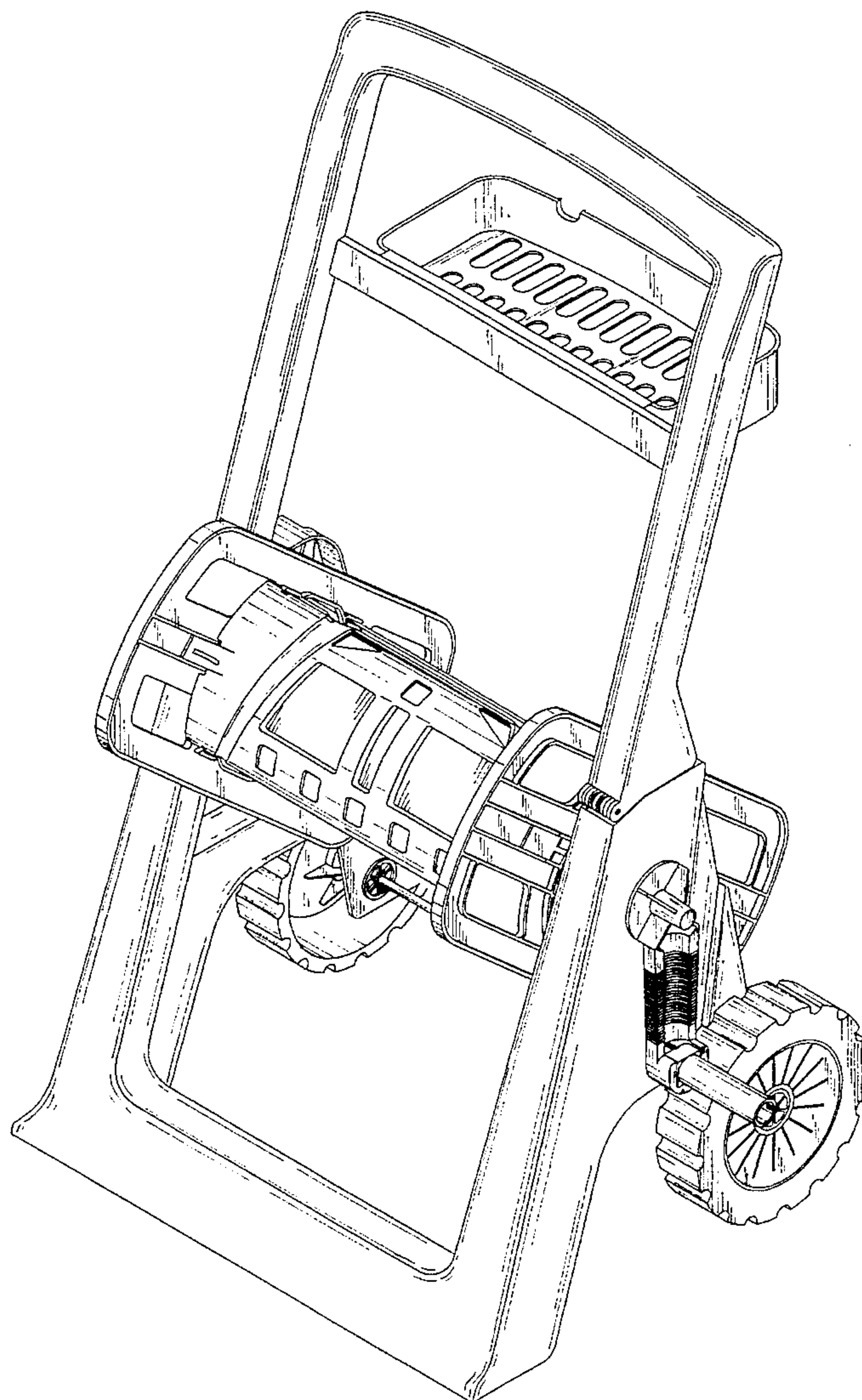

FIG. 1

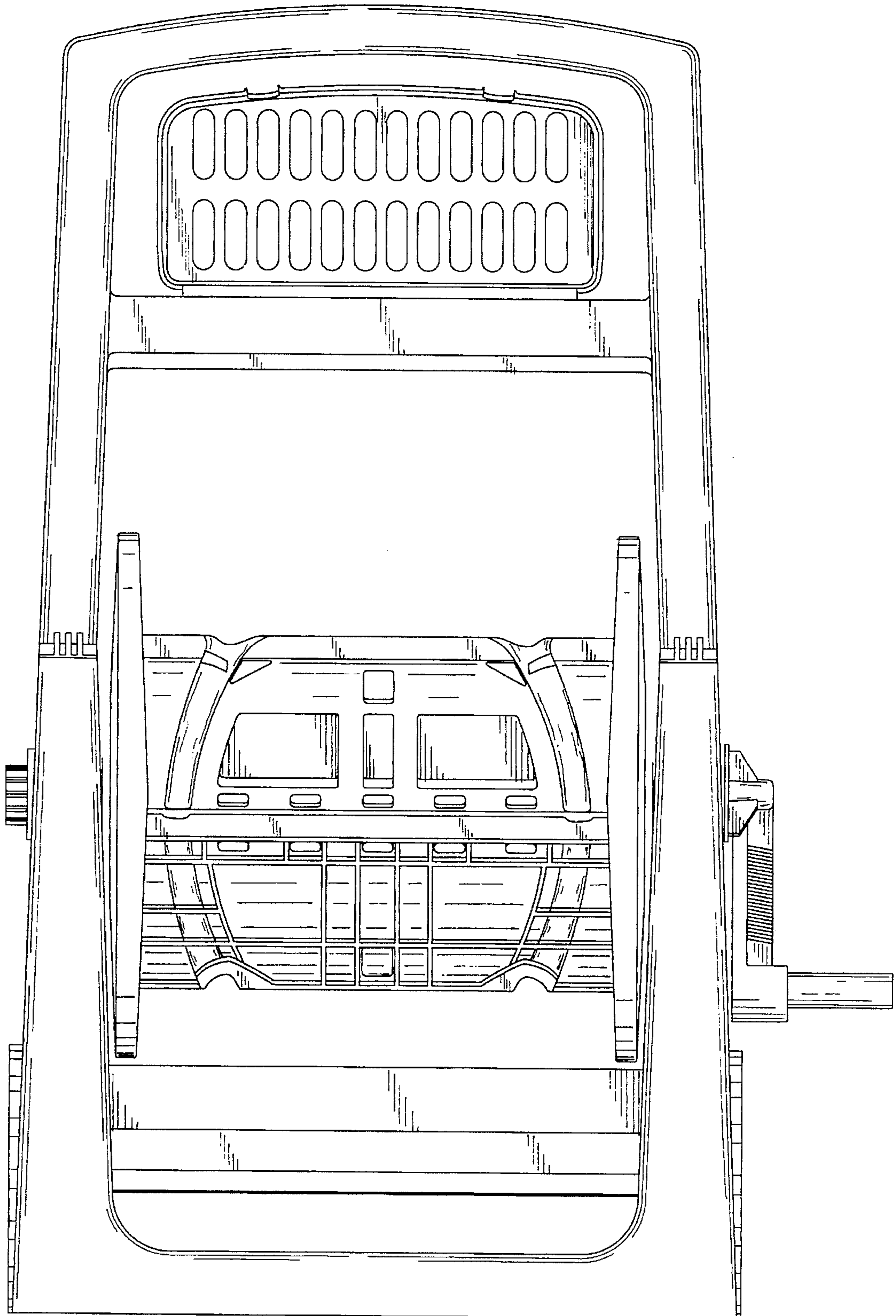

FIG. 2

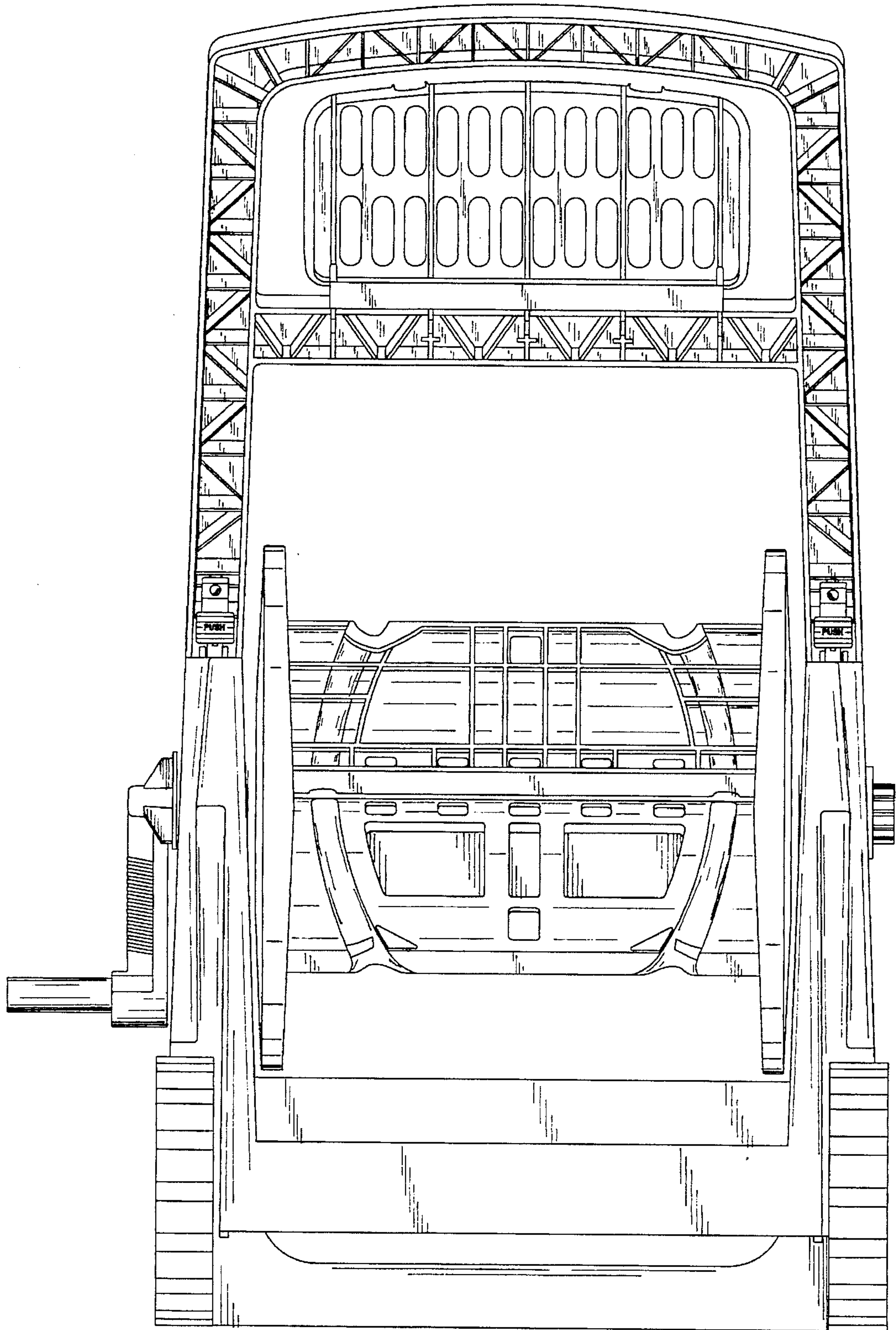

FIG. 3

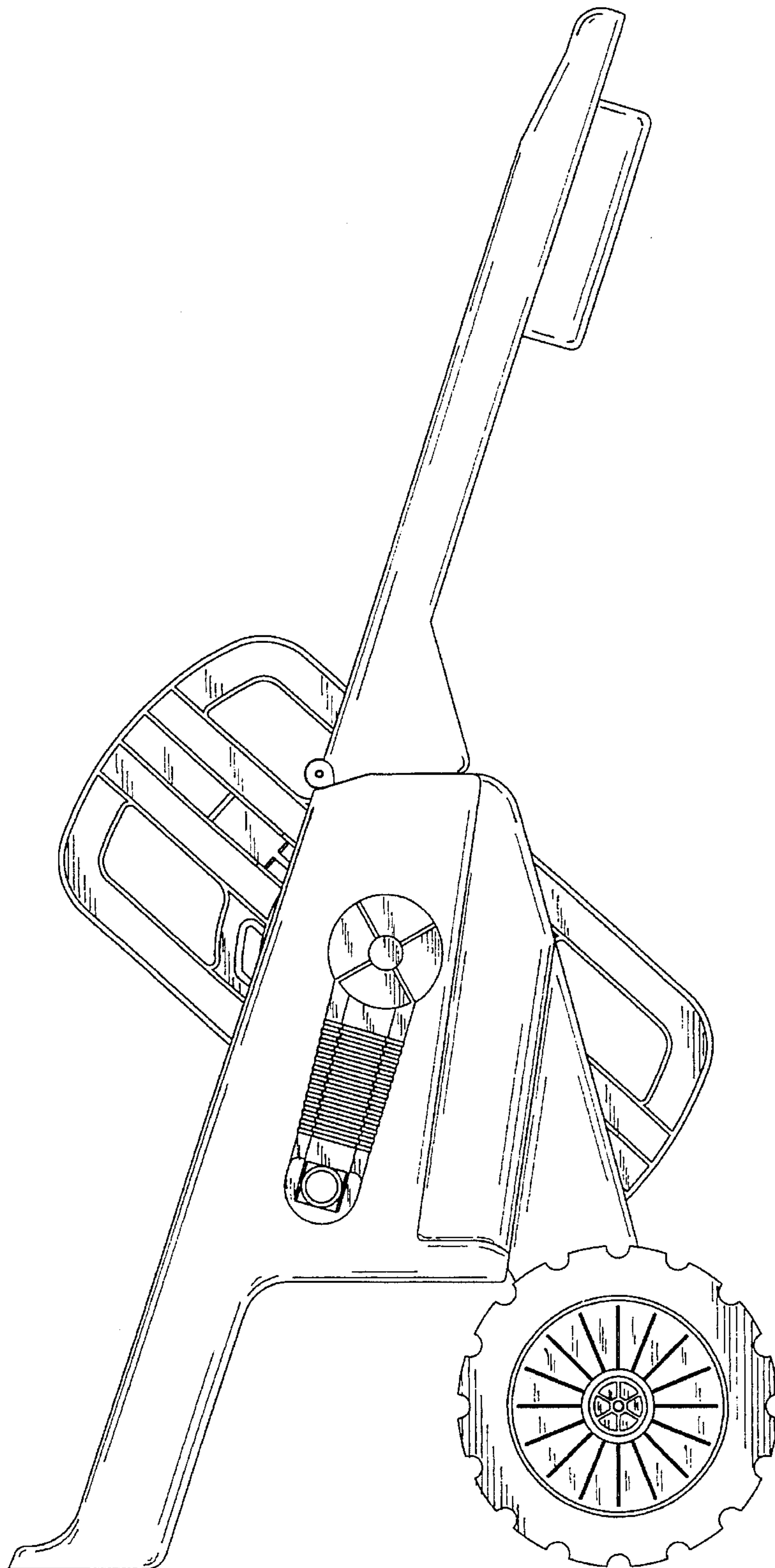

FIG. 4

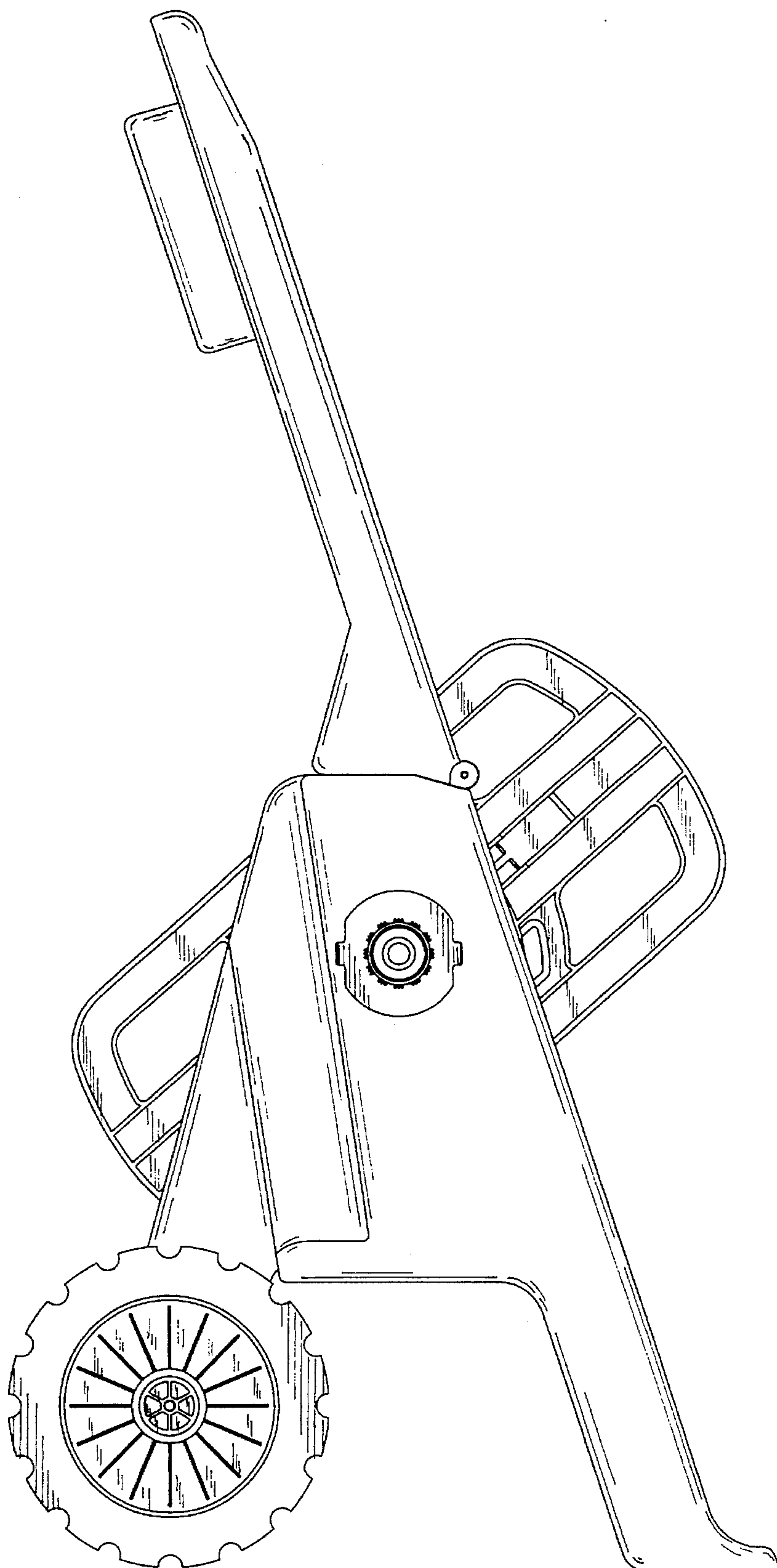

FIG. 5

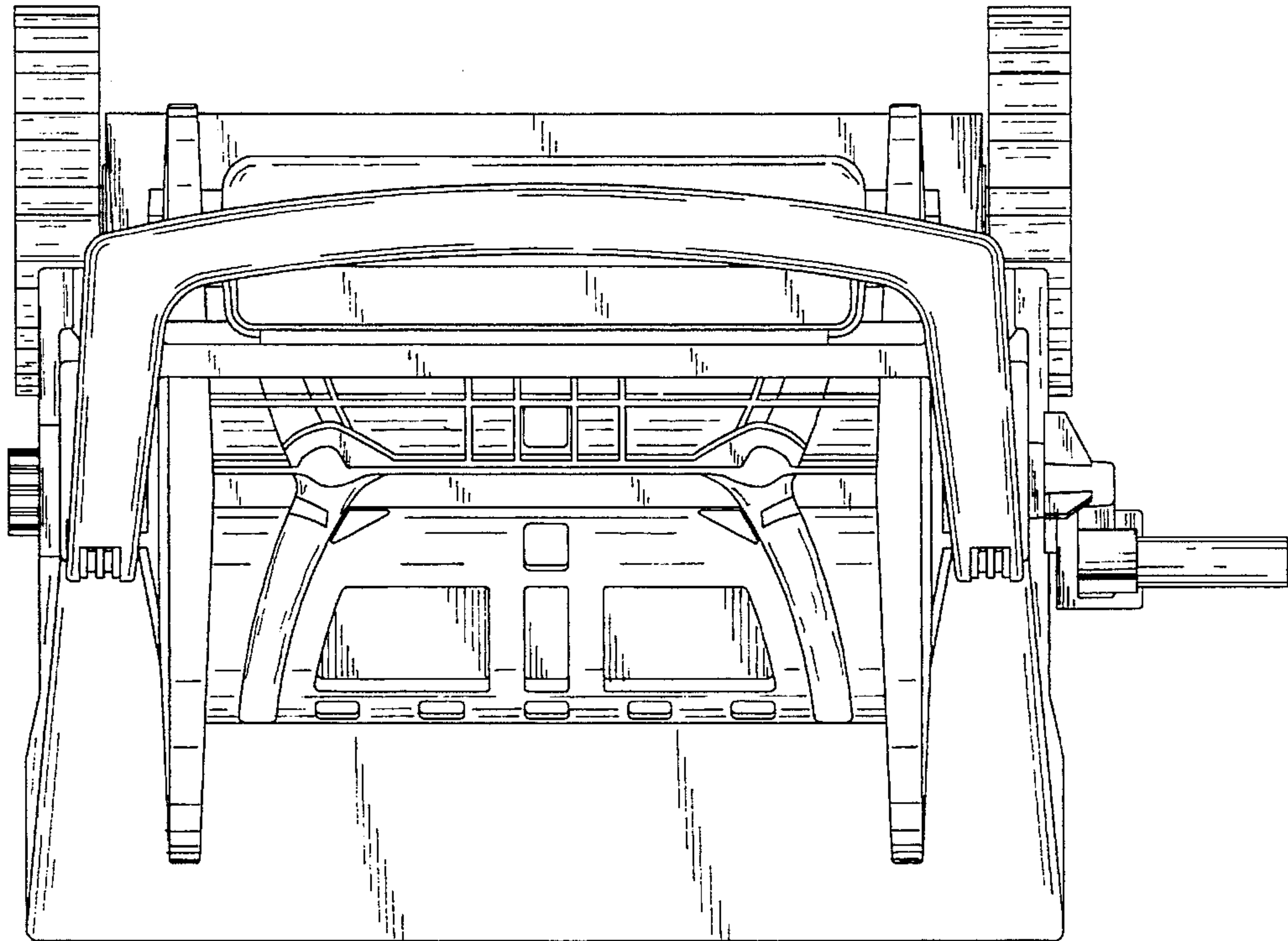

FIG. 6

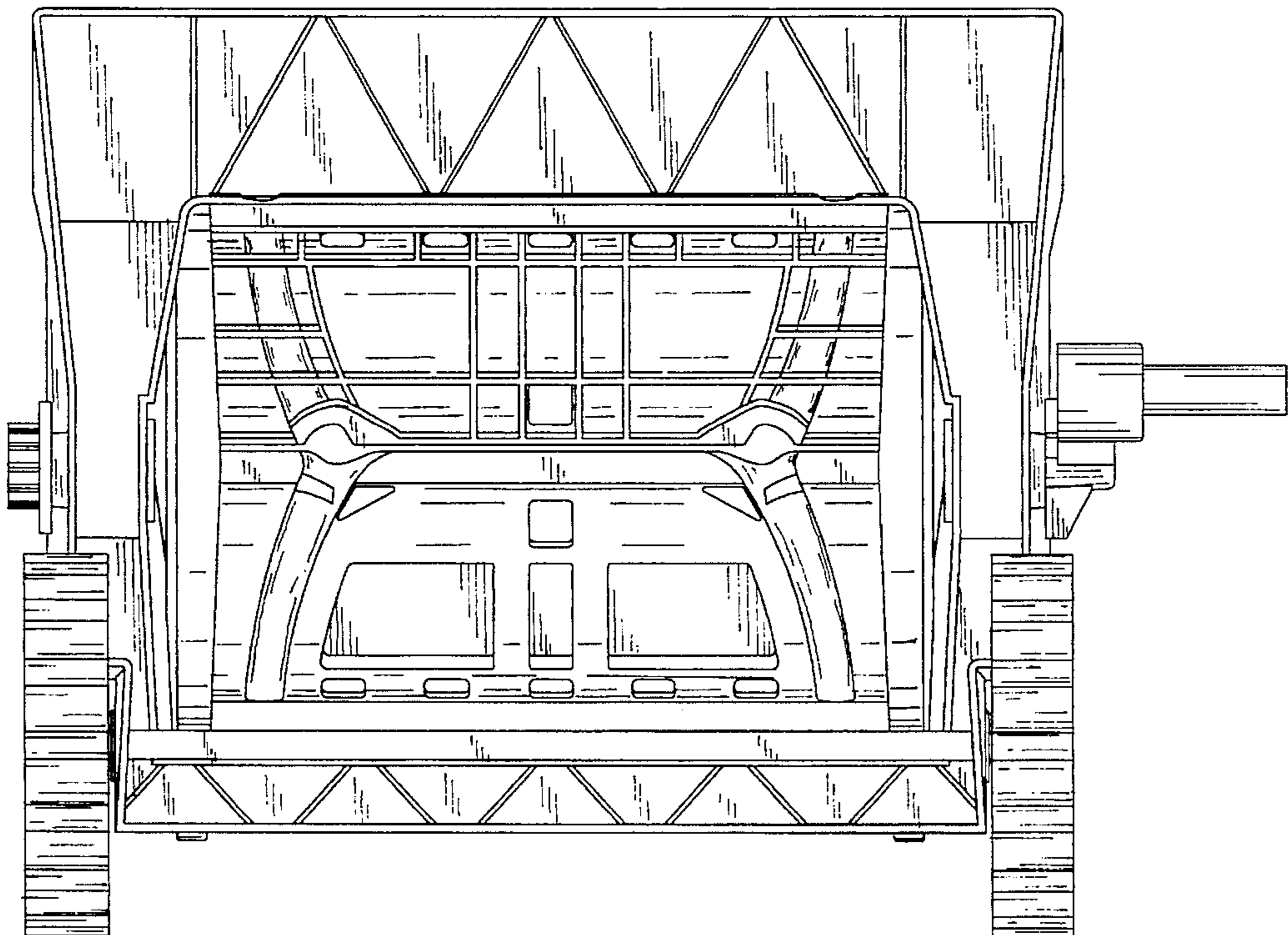

FIG. 7

