



US00D375945S

United States Patent [19]

Shin et al.

[11] Patent Number: **Des. 375,945**

[45] Date of Patent: ****Nov. 26, 1996**

[54] **COMBINED PORTABLE COMPUTER DOCKING STATION AND COMPUTER**

[75] Inventors: **Seong S. Shin**, Cupertino; **Young S. Kim**, Los Altos, both of Calif.

[73] Assignee: **Daewoo Telecom Ltd.**, Compton, Calif.

[**] Term: **14 Years**

[21] Appl. No.: **32,758**

[22] Filed: **Dec. 27, 1994**

[52] U.S. Cl. **D14/107**

[58] Field of Search D14/100, 107, D14/114; D13/184, 199; 361/683-686, 680; 364/708.1; 345/104, 156, 168, 173, 901-905, 87, 160, 168

[56] **References Cited**

U.S. PATENT DOCUMENTS

D. 336,287	6/1993	Mizusugi et al.	D14/107
D. 342,487	12/1993	Iino	D14/107
D. 356,782	3/1995	Leman	D14/107
D. 359,034	6/1995	Kondo	D14/107
5,126,954	6/1992	Morita	361/683
5,182,699	1/1993	Kobayashi et al.	361/683
5,347,425	9/1994	Herron et al.	361/683 X

Primary Examiner—Freda Nunn

Attorney, Agent, or Firm—Hopkins & Carley

[57] **CLAIM**

The ornamental design for a combined portable computer docking station and computer, as shown and described.

DESCRIPTION

FIG. 1 is a top front and left side perspective view of the

combined portable computer docking station and computer showing our new design;

FIG. 2 is an exploded top front and right side perspective view thereof showing the front end of the docking station in the unfolded position and the lid of the computer closed;

FIG. 3 is a top view of the docking station thereof shown separately for clarity of illustration only;

FIG. 4 is a bottom view thereof;

FIG. 5 is a left side view thereof;

FIG. 6 is a right side view thereof;

FIG. 7 is a front view thereof;

FIG. 8 is a rear view thereof;

FIG. 9 is a right side view thereof similar to FIG. 6 and shown with the front end in the unfolded position;

FIG. 10 is a top view of the portable computer thereof shown with the lid closed and also shown separately for clarity of illustration only;

FIG. 11 is a top view thereof similar to FIG. 10 and shown with the lid open;

FIG. 12 is a front view thereof;

FIG. 13 is a rear view thereof;

FIG. 14 is a bottom view thereof;

FIG. 15 is a right side view thereof with the lid closed; and,

FIG. 16 is a left side view thereof.

1 Claim, 5 Drawing Sheets

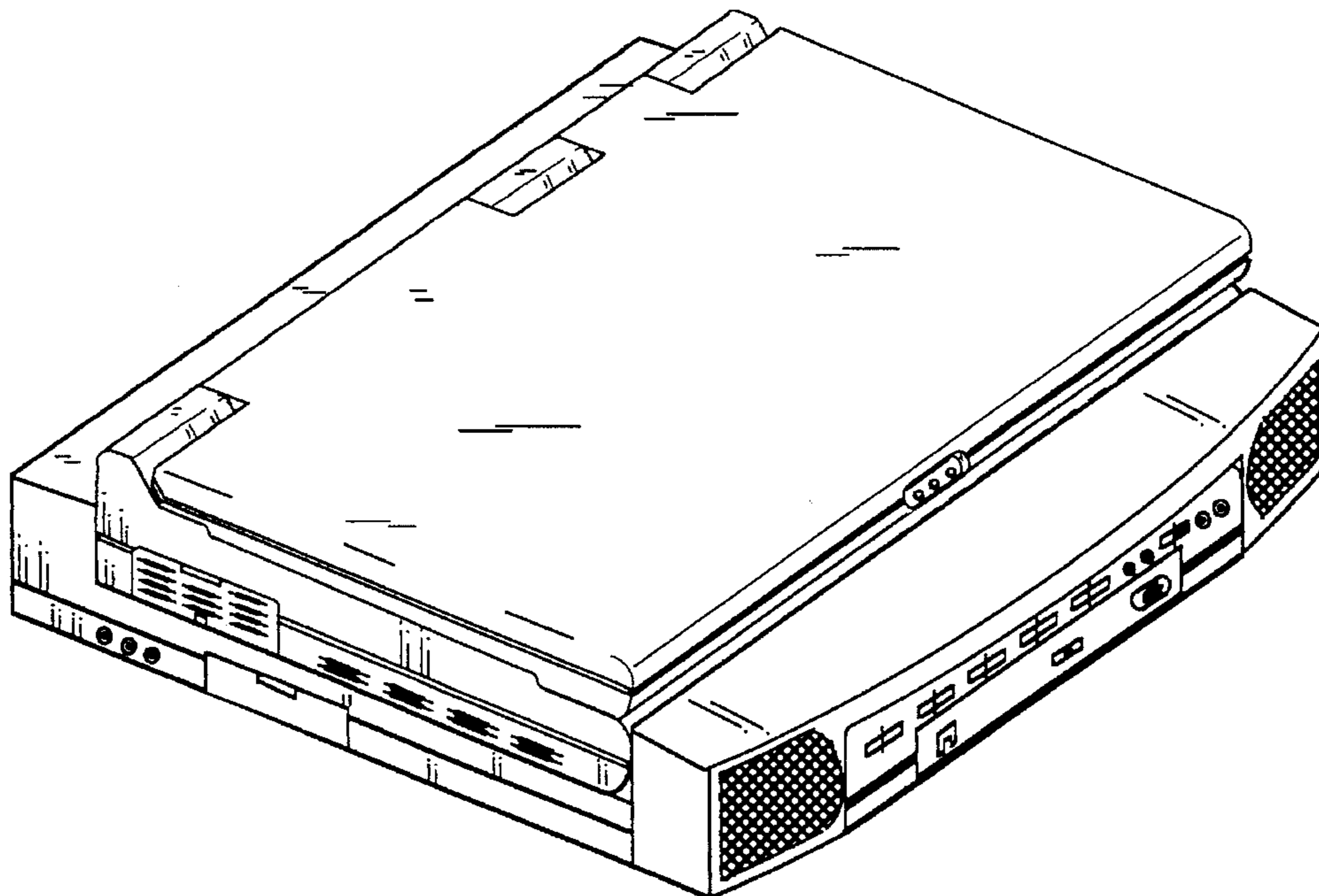

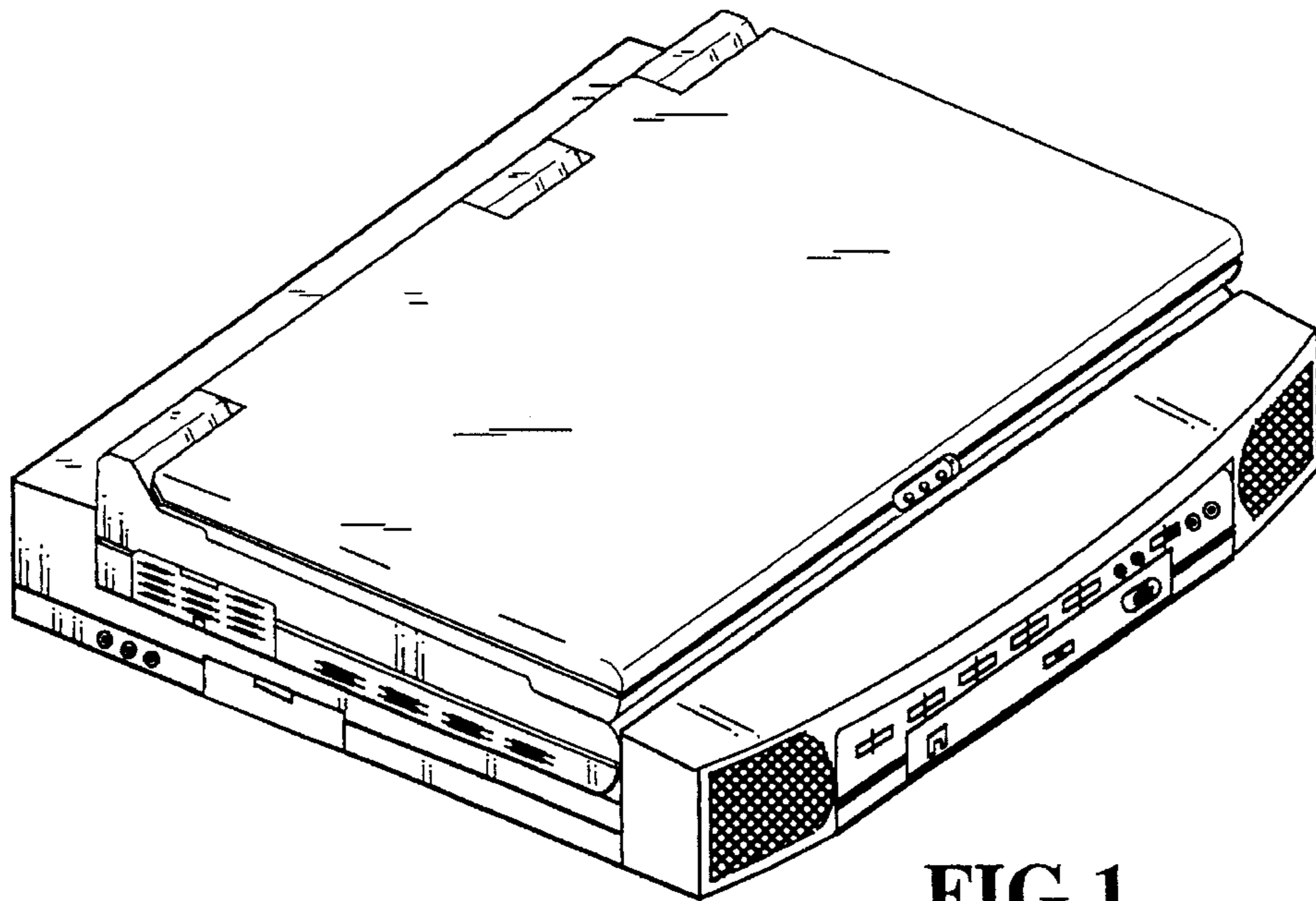

FIG. 1

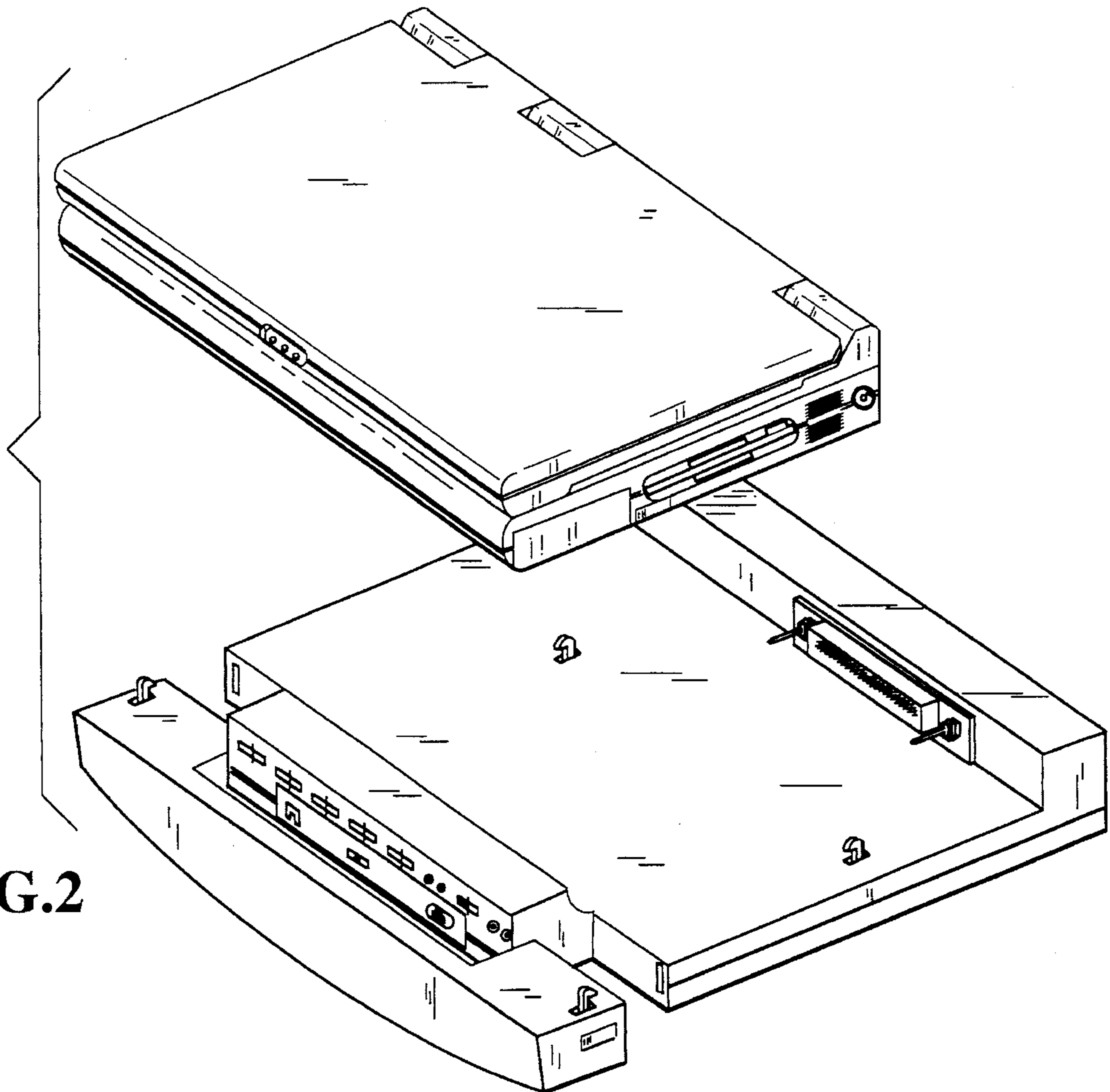

FIG. 2

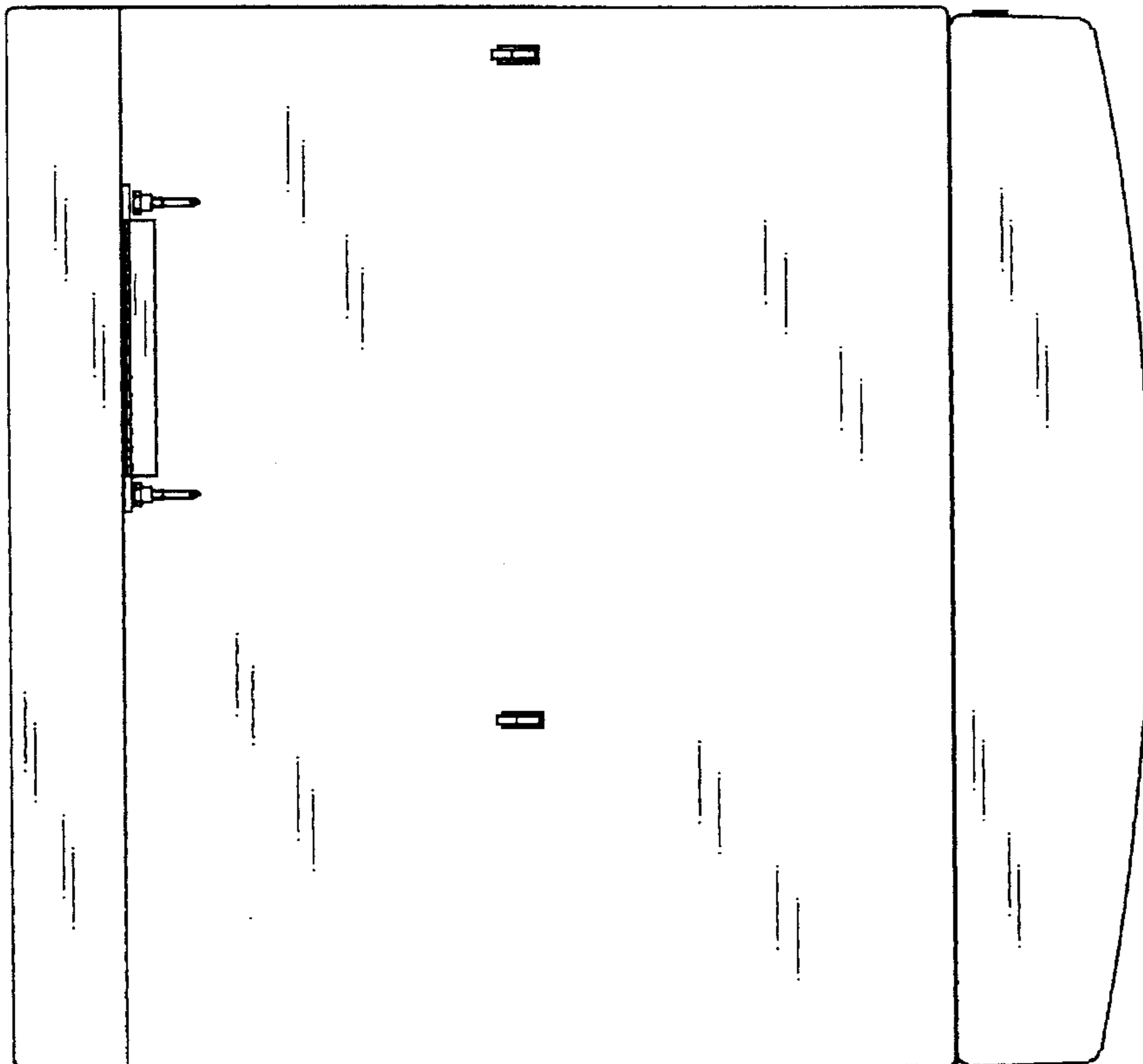

FIG.3

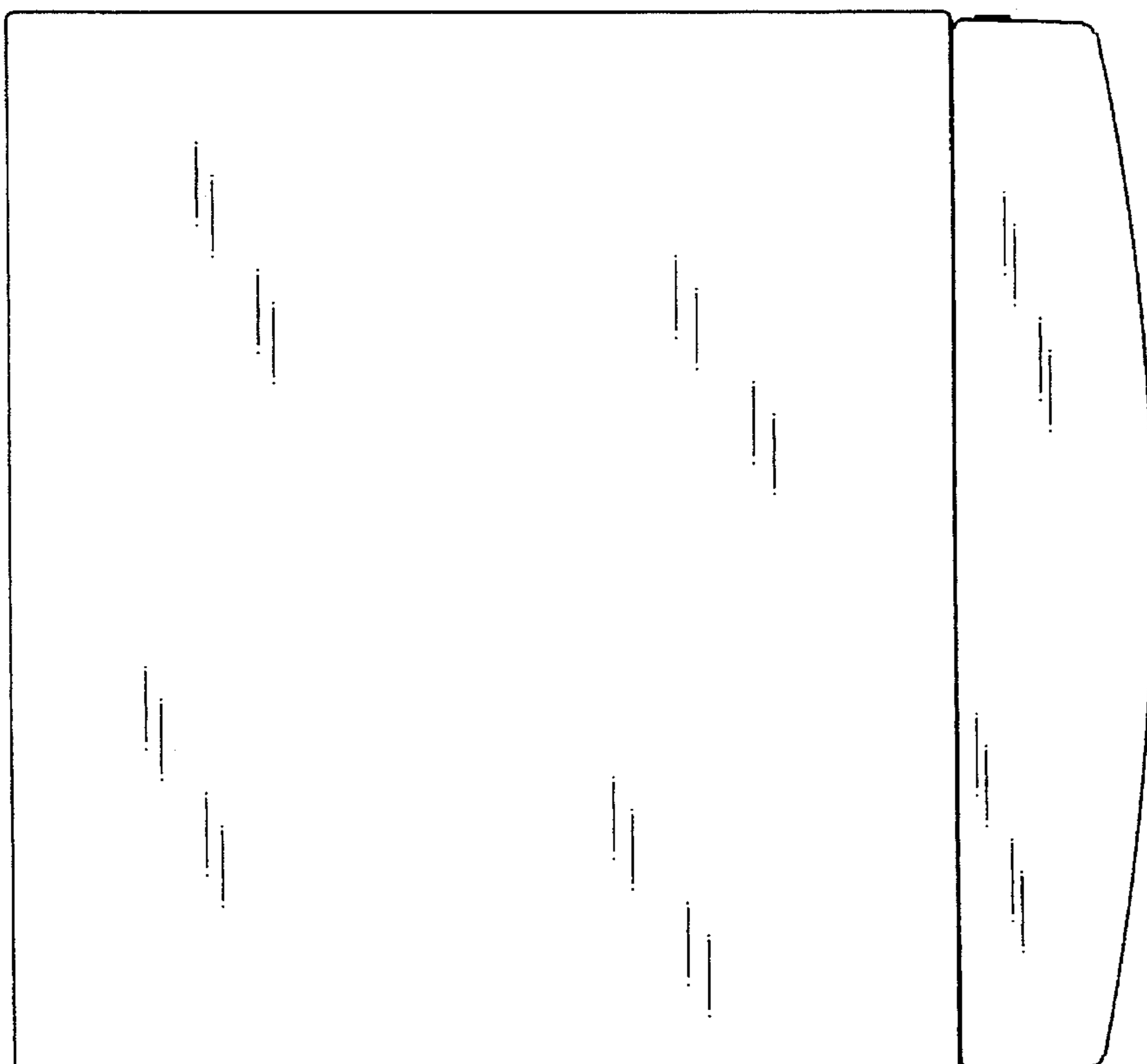

FIG.4

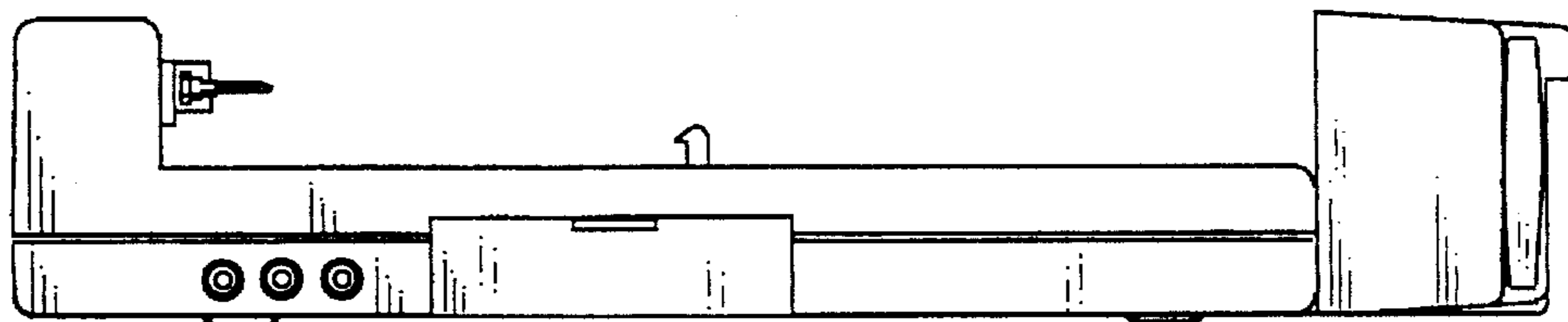

FIG. 5

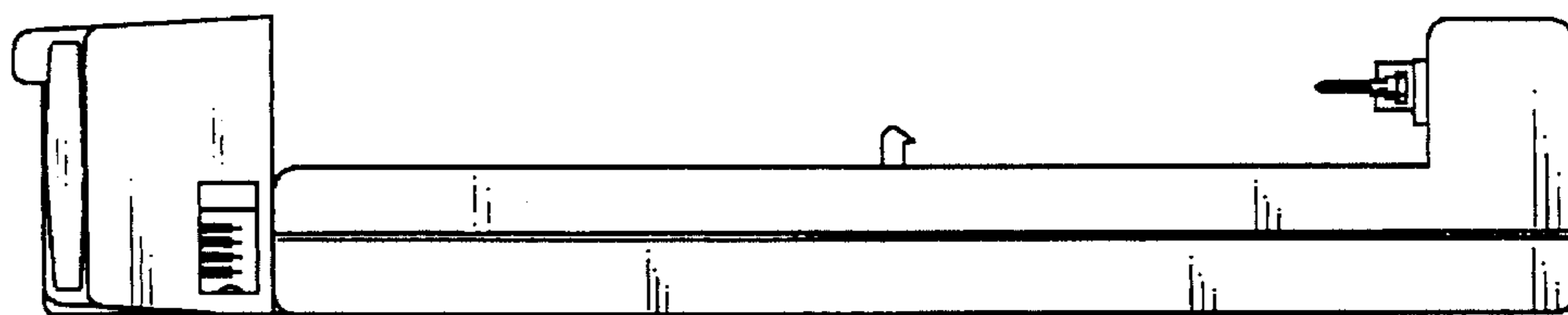

FIG. 6

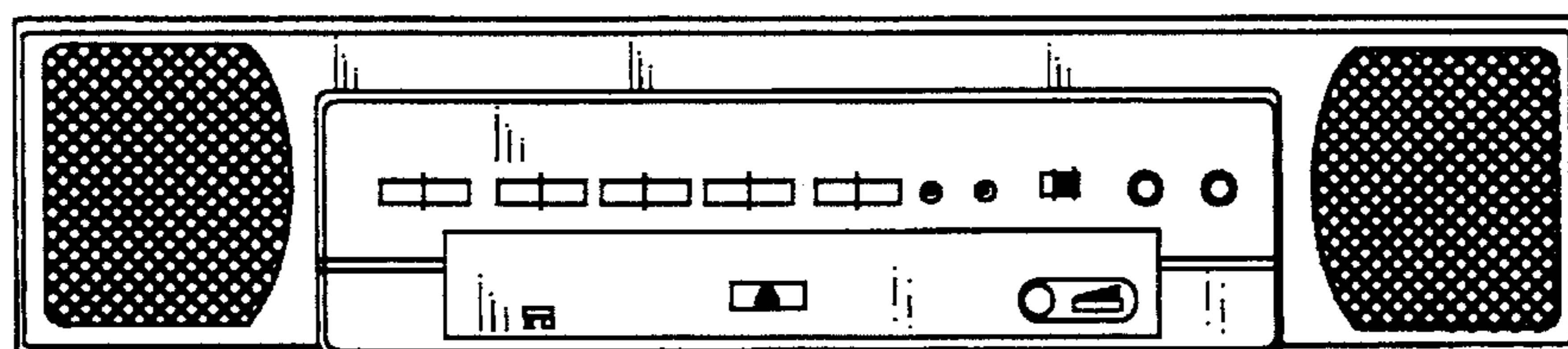

FIG. 7

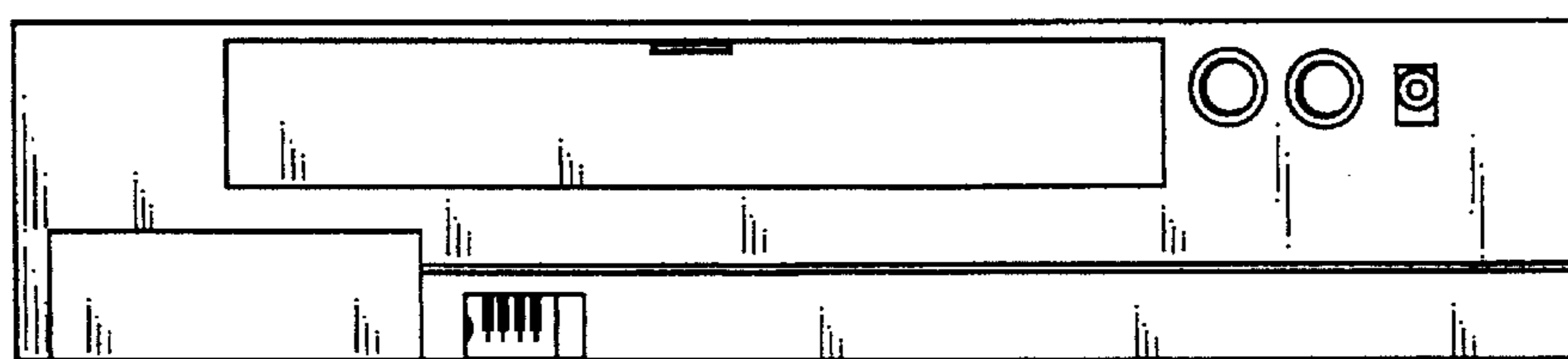

FIG. 8

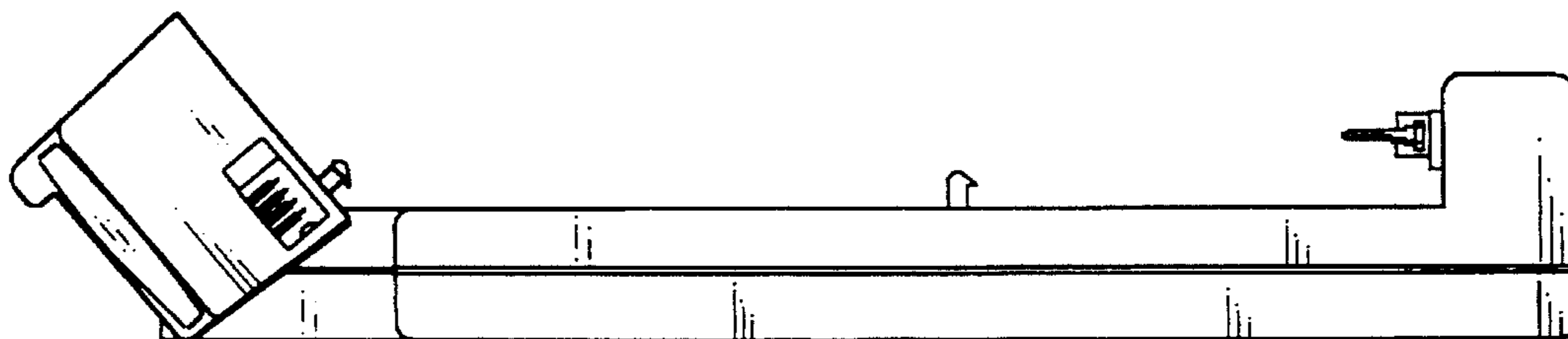

FIG. 9

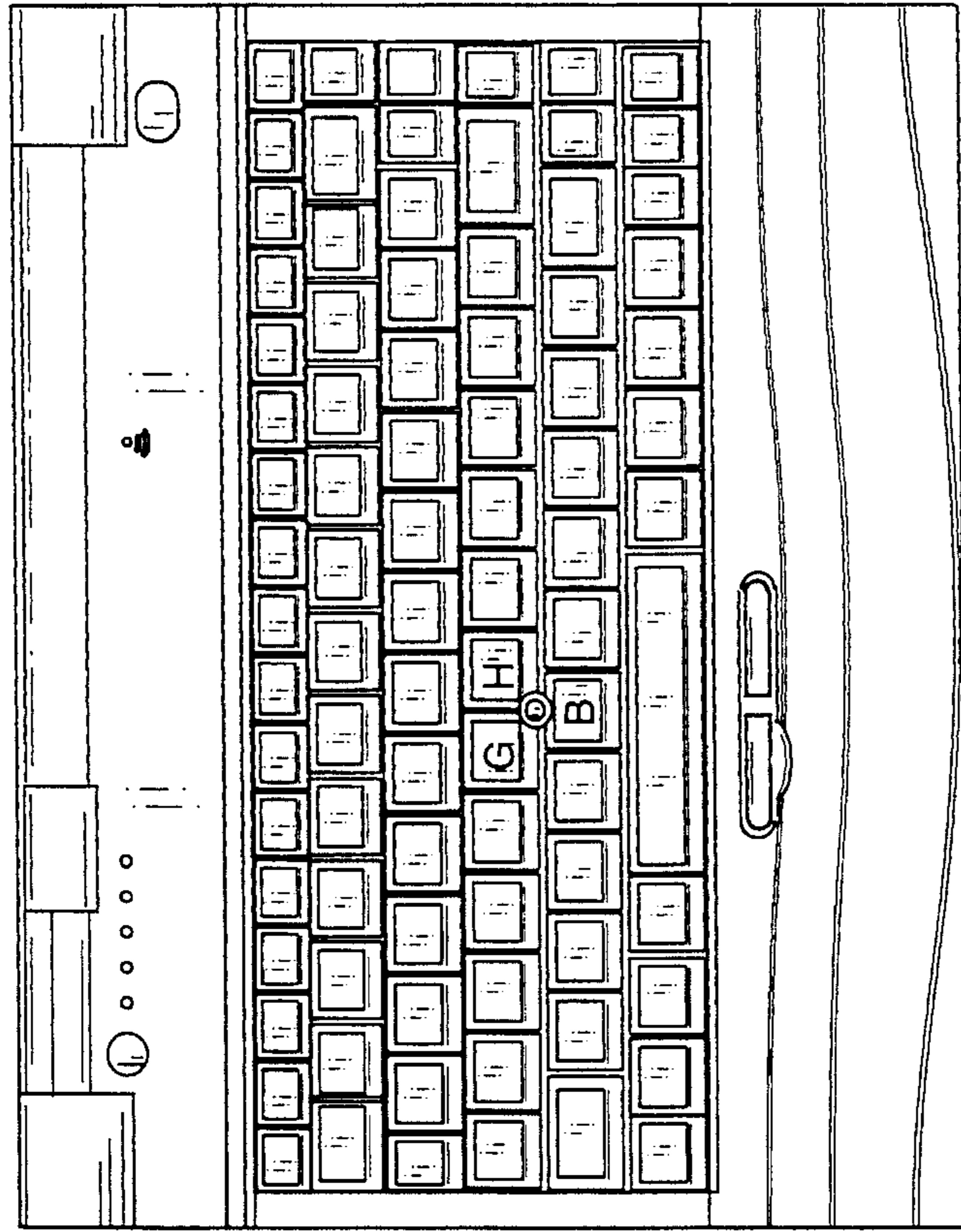

FIG. 11

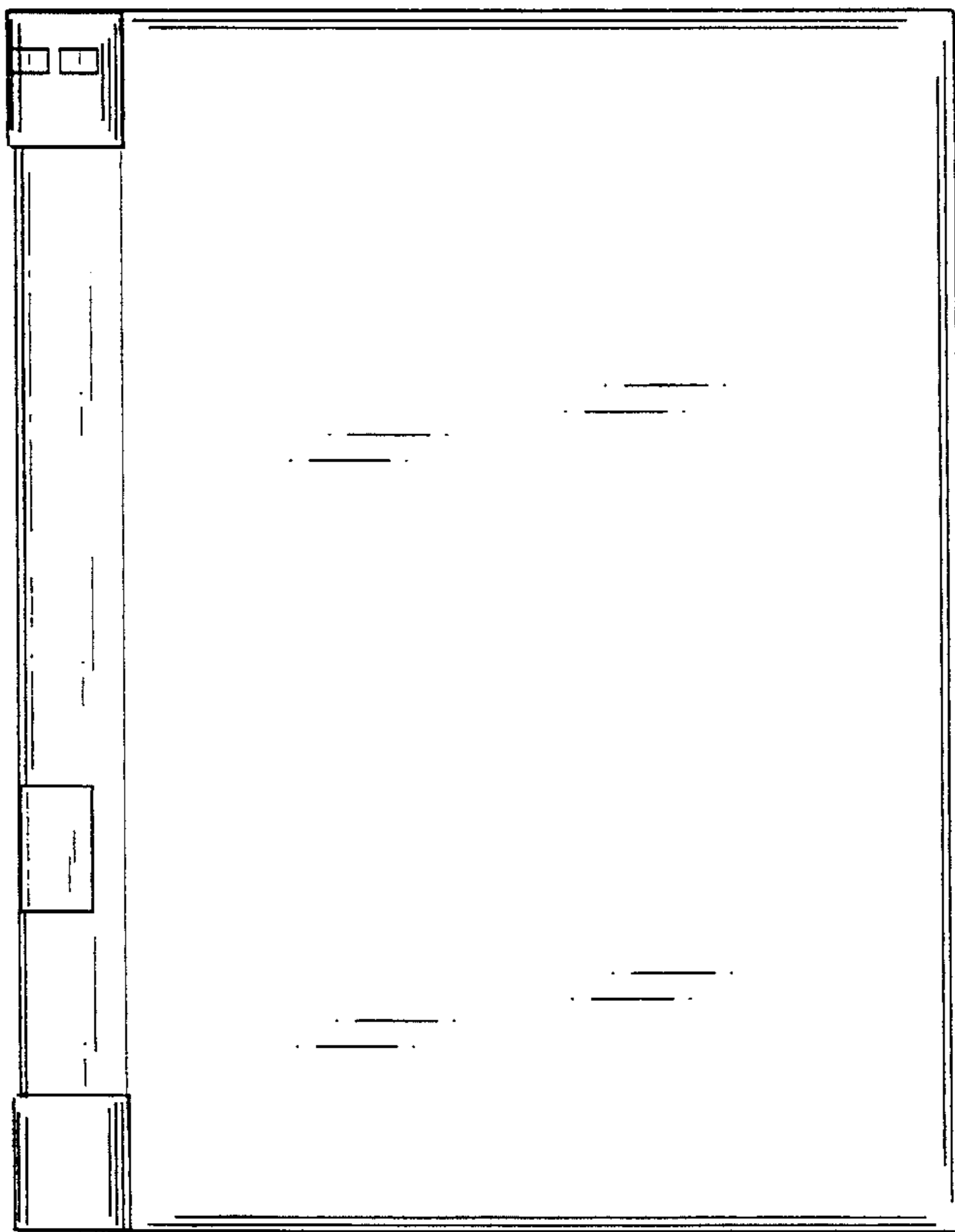

FIG. 10

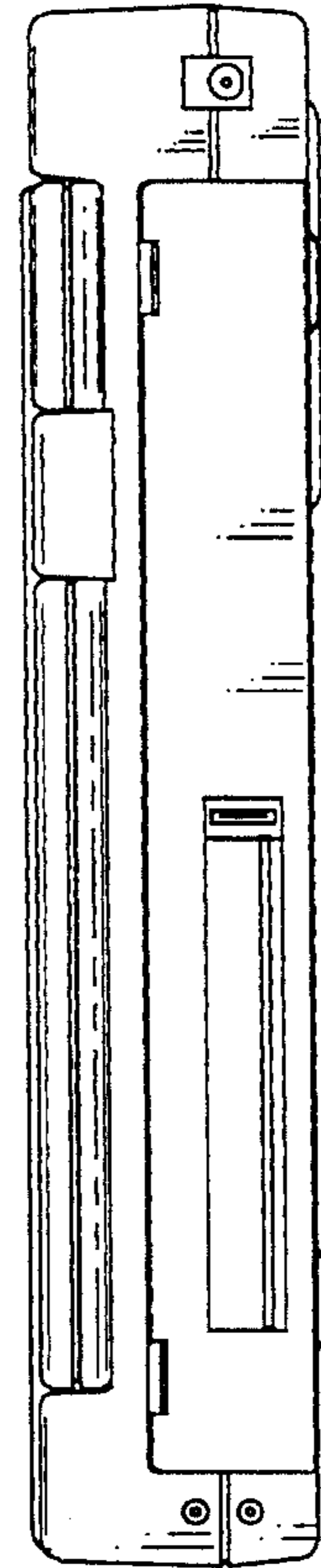

FIG. 13

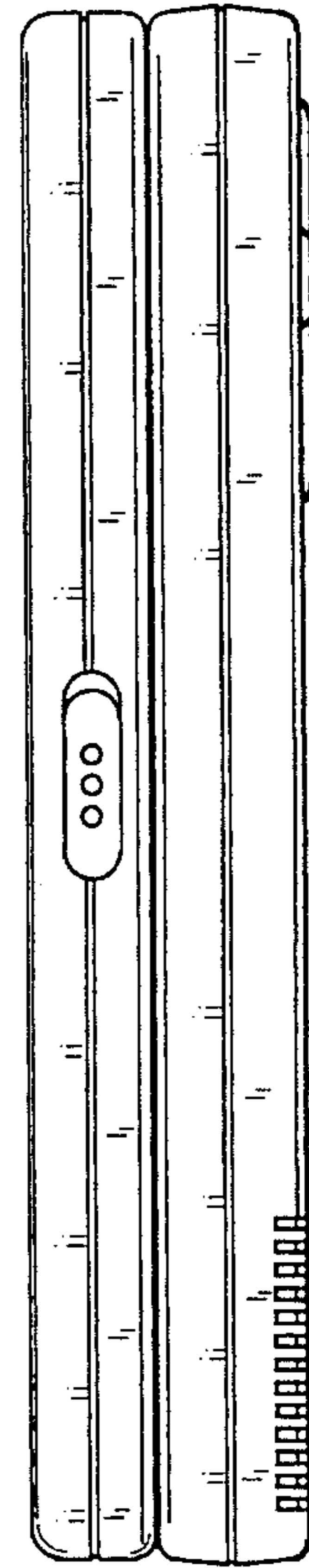

FIG. 12

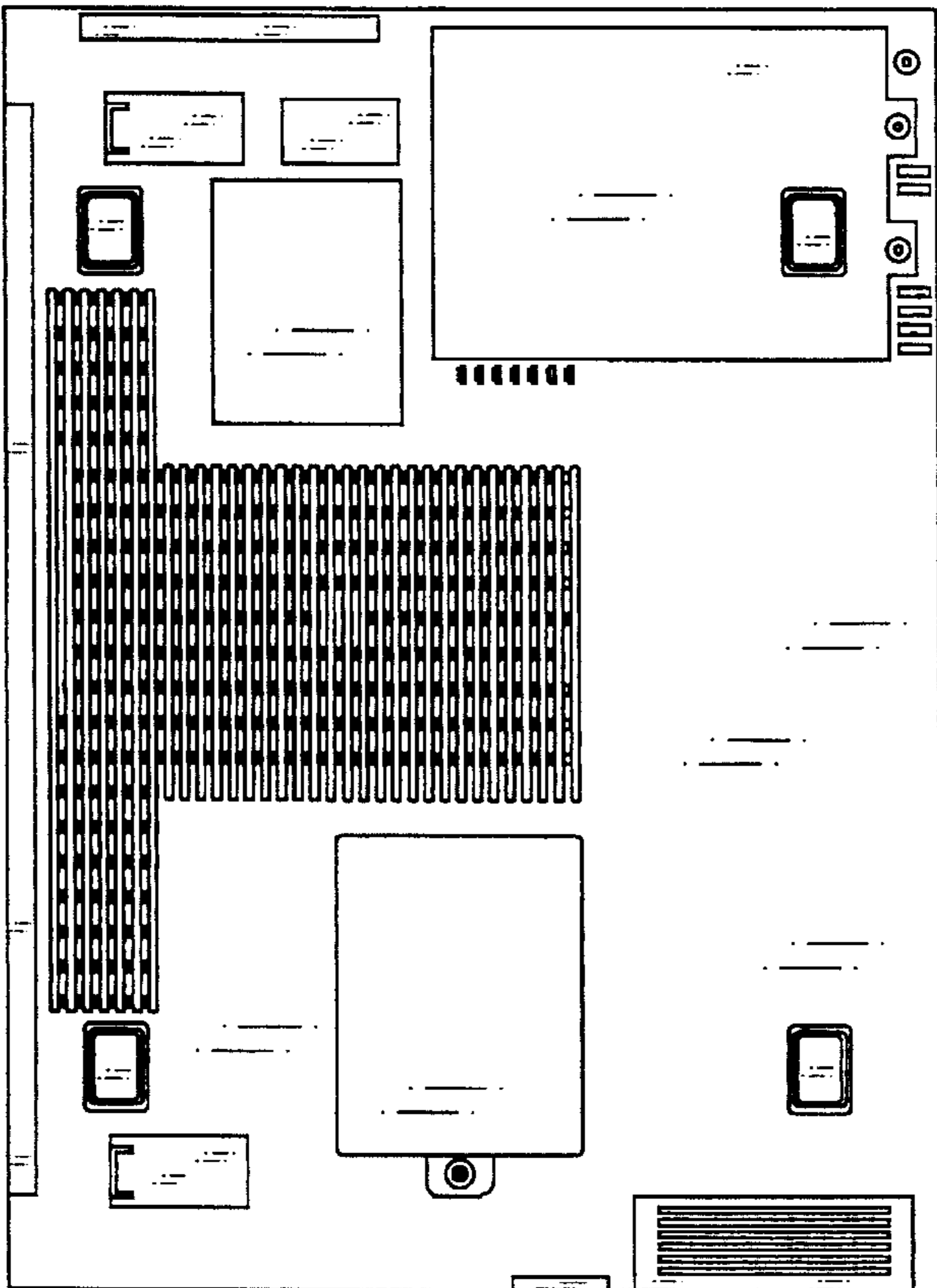

FIG. 14

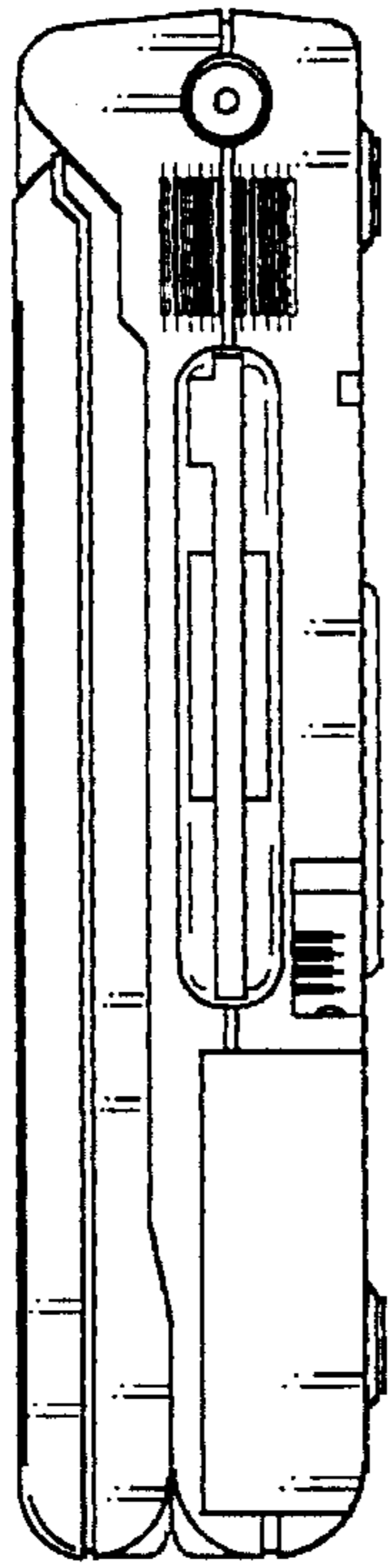

FIG. 15

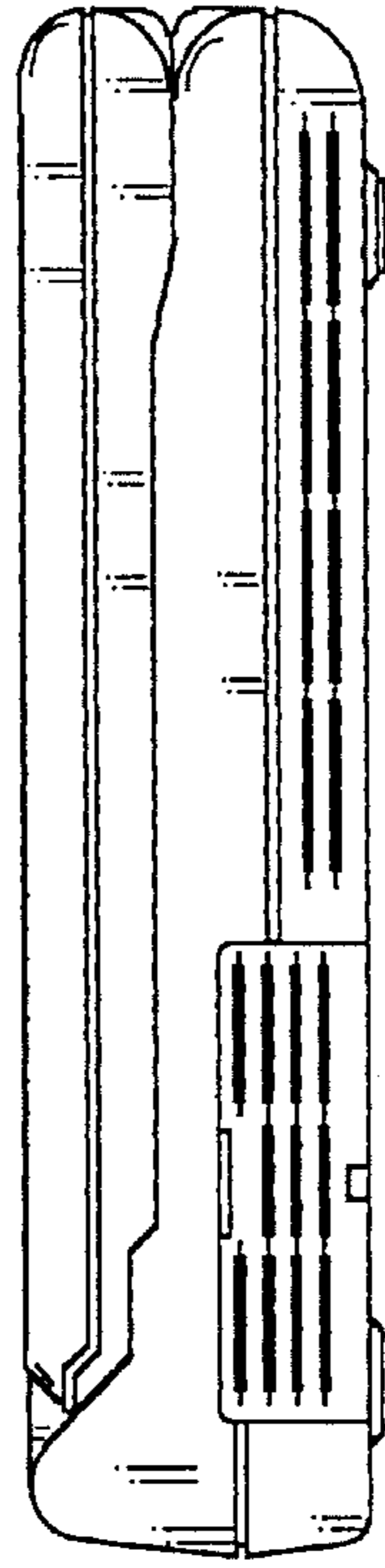

FIG. 16