



US00D375706S

United States Patent [19]
Haung

[11] **Patent Number: Des. 375,706**

[45] **Date of Patent: **Nov. 19, 1996**

[54] **STROLLER WITH DOUBLE SEATS**

D. 359,937 7/1995 Yoshie et al. D12/128

[76] Inventor: **Mark Haung**, 58, Ma Yuan West St.,
Taichung, Taiwan

Primary Examiner—Kay H. Chin

[**] Term: **14 Years**

[57] **CLAIM**

[21] Appl. No.: **40,736**

The ornamental design for a stroller with double seats, as shown and described.

[22] Filed: **Jun. 26, 1995**

DESCRIPTION

[52] **U.S. Cl.** **D12/129**

FIG. 1 is a perspective view of a stroller with double seats showing my design;

[58] **Field of Search** D12/128, 129;
280/642, 680, 658, 47.4, 647, 644, 30,
42; 297/45, 39

FIG. 2 is a front elevational view thereof;

FIG. 3 is a rear elevational view thereof;

FIG. 4 is a right side elevational view thereof, and a left side elevational view is the same;

FIG. 5 is a top plan view thereof; and,

FIG. 6 is a bottom plan view thereof.

[56] **References Cited**

U.S. PATENT DOCUMENTS

- D. 311,363 10/1990 Lin D12/129
- D. 321,850 11/1991 Mong-Hsing D12/129
- D. 328,047 7/1992 Huang D12/128

1 Claim, 4 Drawing Sheets

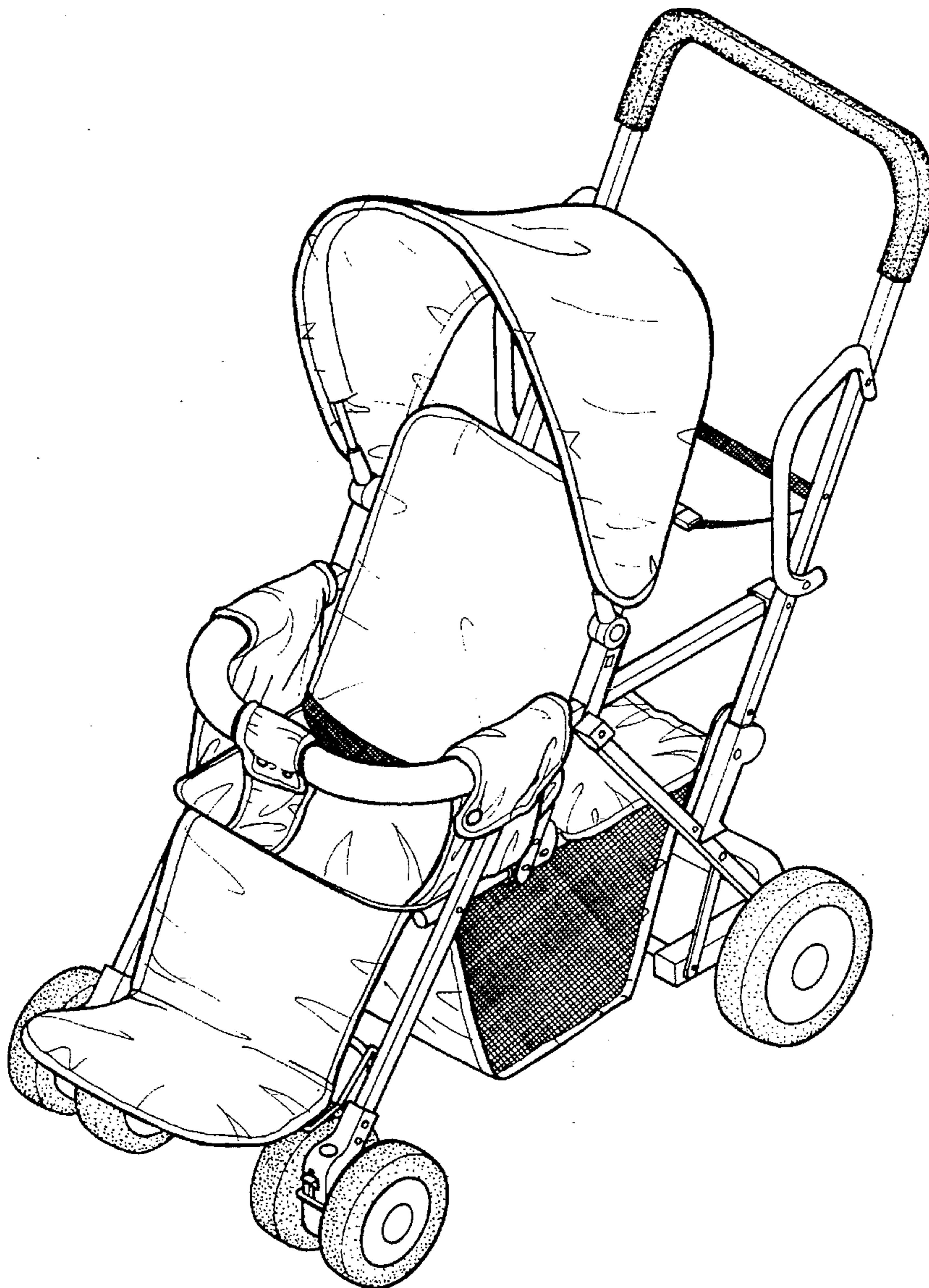

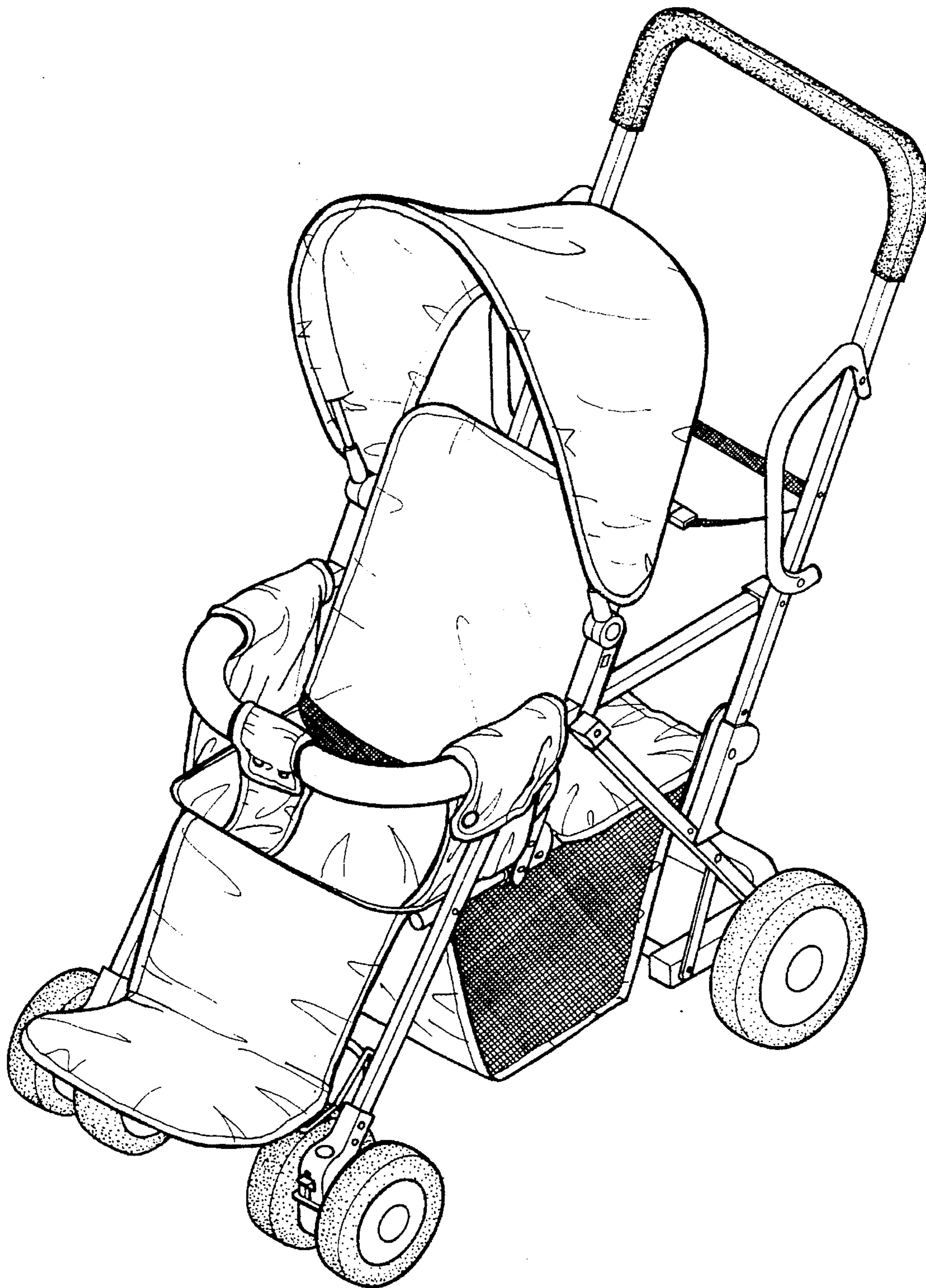

FIG. 1

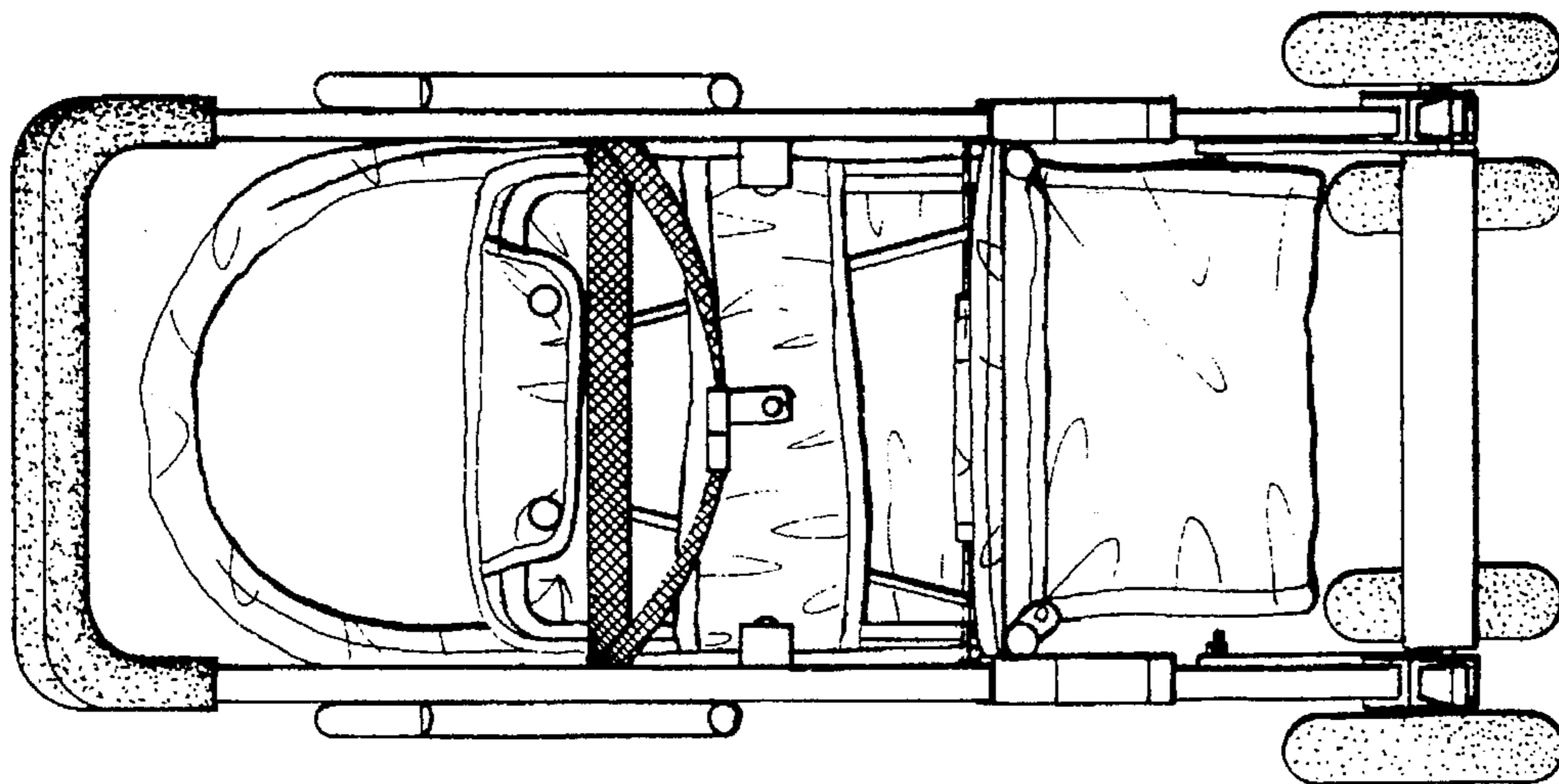

FIG. 3

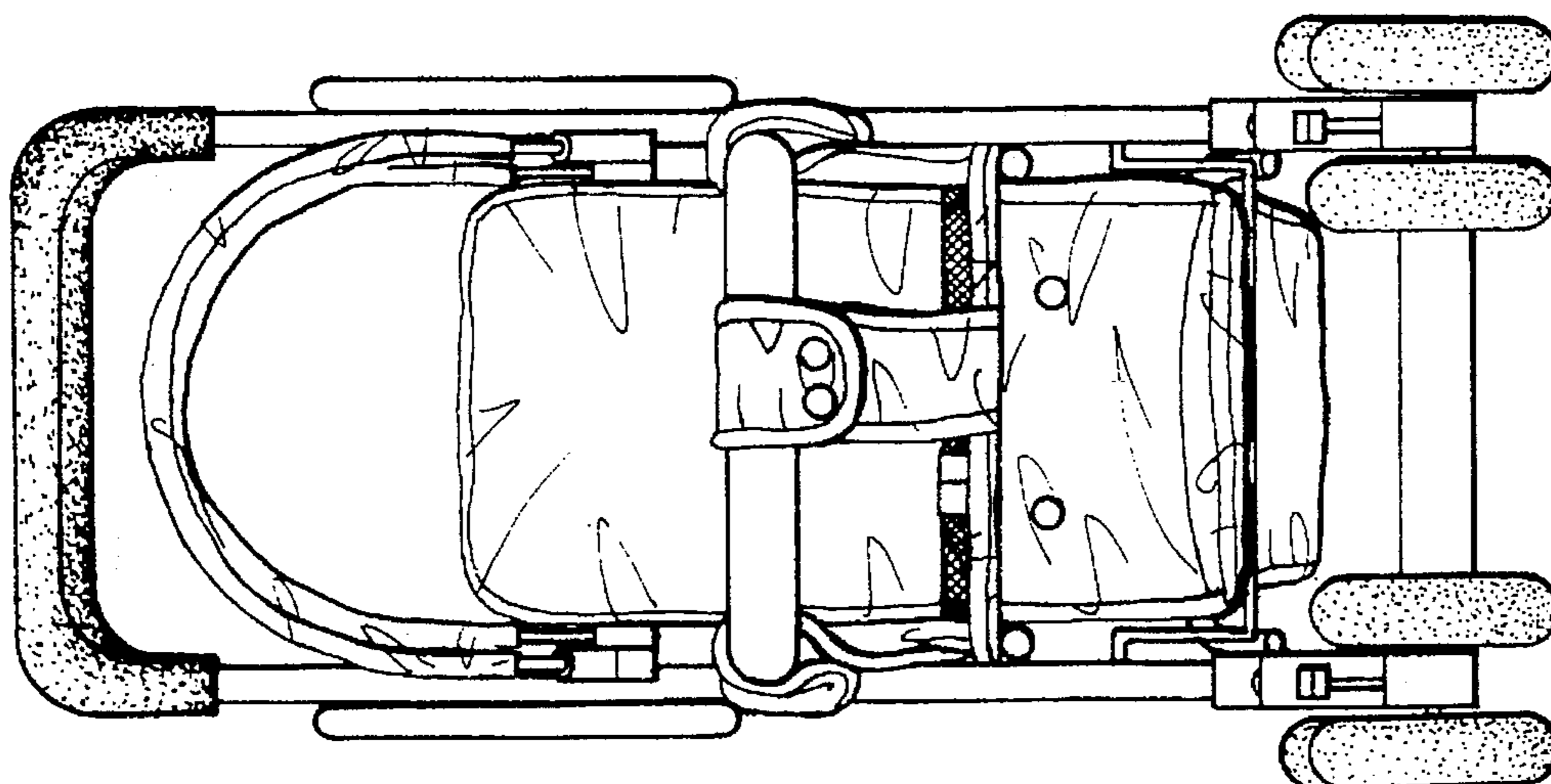

FIG. 2



FIG. 4

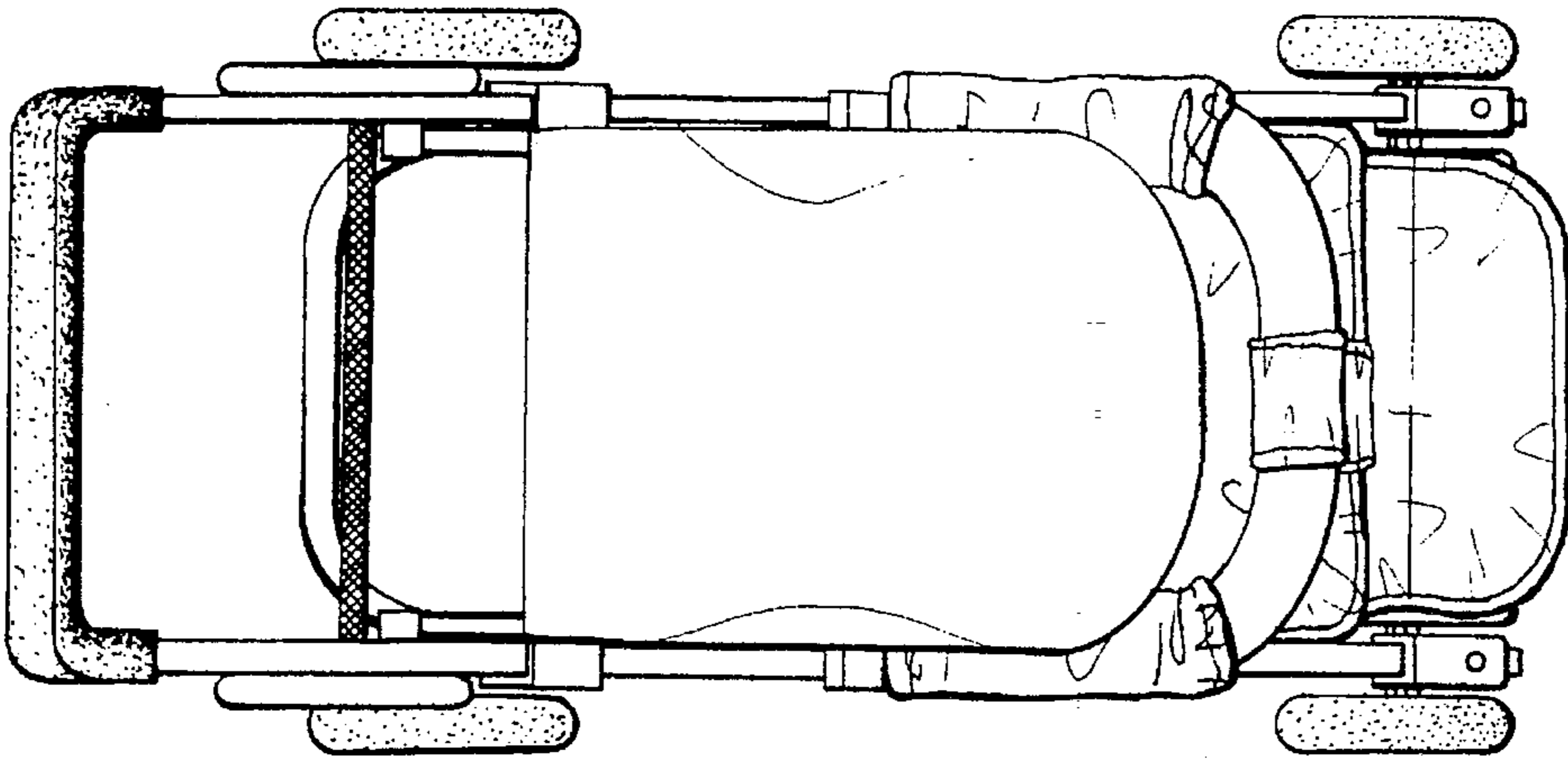

FIG. 5

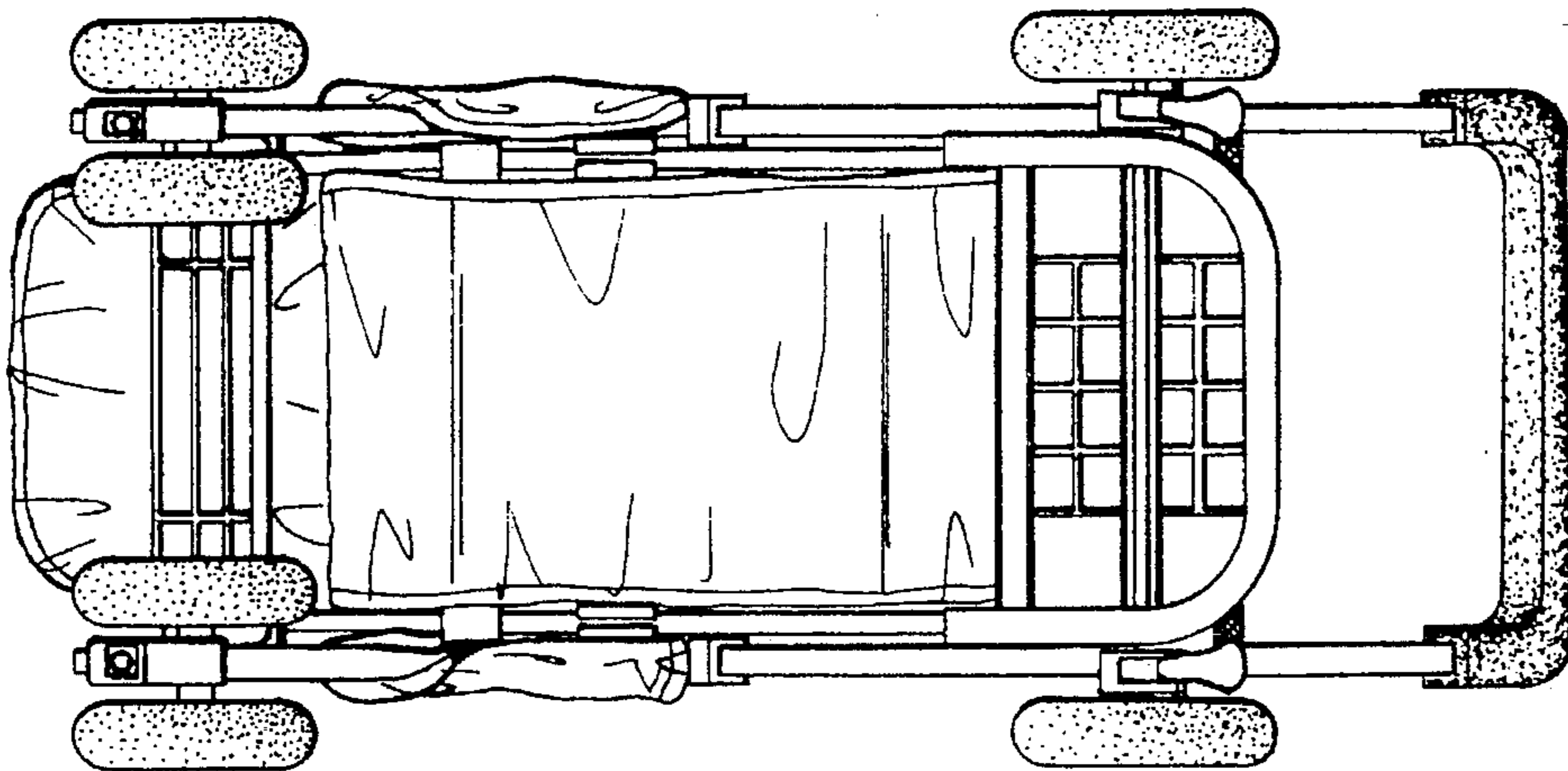

FIG. 6

UNITED STATES PATENT AND TRADEMARK OFFICE
CERTIFICATE OF CORRECTION

PATENT NO. : D375,706
APPLICATION NO. : 29/040736
DATED : November 19, 1996
INVENTOR(S) : Mark Haung et al.

Page 1 of 1

It is certified that error appears in the above-identified patent and that said Letters Patent is hereby corrected as shown below:

On the Title Page

The inventorship should read as follows:

[76] Inventors: Mark Huang, 58, Ma Yuan West St.,
aichung, Taiwan
Denny Tsai
Chino Hills, California

Signed and Sealed this
Twentieth Day of November, 2018

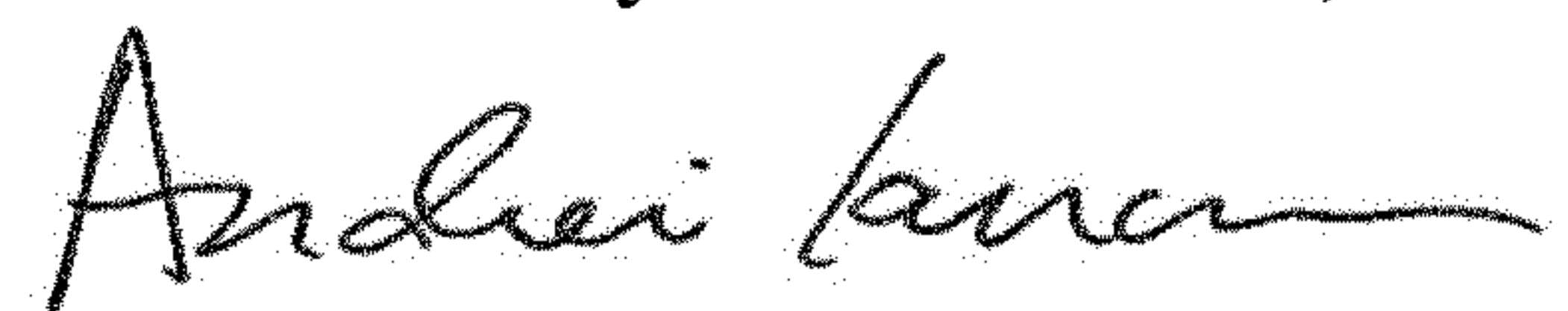

Andrei Iancu
Director of the United States Patent and Trademark Office