



US00D375671S

United States Patent [19]
Heithe

[11] **Patent Number: Des. 375,671**
[45] **Date of Patent: **Nov. 19, 1996**

[54] **PULL AND LATCH GUARD**

DESCRIPTION

[75] Inventor: **Michael E. Heithe**, Duarte, Calif.
[73] Assignee: **NT Quality Hardware**, Brea, Calif.
[**] Term: **14 Years**
[21] Appl. No.: **44,181**
[22] Filed: **Sep. 20, 1995**
[52] U.S. Cl. **D8/346; D8/301**
[58] Field of Search **D8/343, 346, 300, D8/301, 302, 307, 304, 315; 292/346, DIG. 63, DIG. 30; 16/110 R, DIG. 32**

FIG. 1 is a perspective view of my ornamental design for a pull and latch guard showing our new design;
FIG. 2 is a front elevational view thereof;
FIG. 3 is a top plan view thereof;
FIG. 4 is a back elevational view thereof;
FIG. 5 is a bottom plan view thereof;
FIG. 6 is a right-side elevational view thereof;
FIG. 7 is a left-side elevational view thereof;
FIG. 8 is a perspective view of a second embodiment of my ornamental design for a pull and latch guard showing our new design;
FIG. 9 is a front elevational view of the embodiment shown in FIG. 8;
FIG. 10 is a top plan view of the embodiment shown in FIG. 8;
FIG. 11 is a back elevational view of the embodiment shown in FIG. 8;
FIG. 12 is a bottom plan view of the embodiment shown in FIG. 8;
FIG. 13 is a right-side elevational view of the embodiment shown in FIG. 8; and,
FIG. 14 is a left-side elevational view of the embodiment shown in FIG. 8.

[56] **References Cited**

U.S. PATENT DOCUMENTS

D. 242,597	12/1976	Gamus	D8/343
D. 265,720	8/1982	Harrison	D8/346
D. 353,319	12/1994	Eckert	D8/346
D. 354,670	1/1995	Simon et al.	D8/314 X
4,751,834	6/1988	Beck	292/346 X

Primary Examiner—Brian N. Vinson
Attorney, Agent, or Firm—Don B. Finkelstein

[57] **CLAIM**

The ornamental design for pull and latch guard, as shown and described.

1 Claim, 6 Drawing Sheets

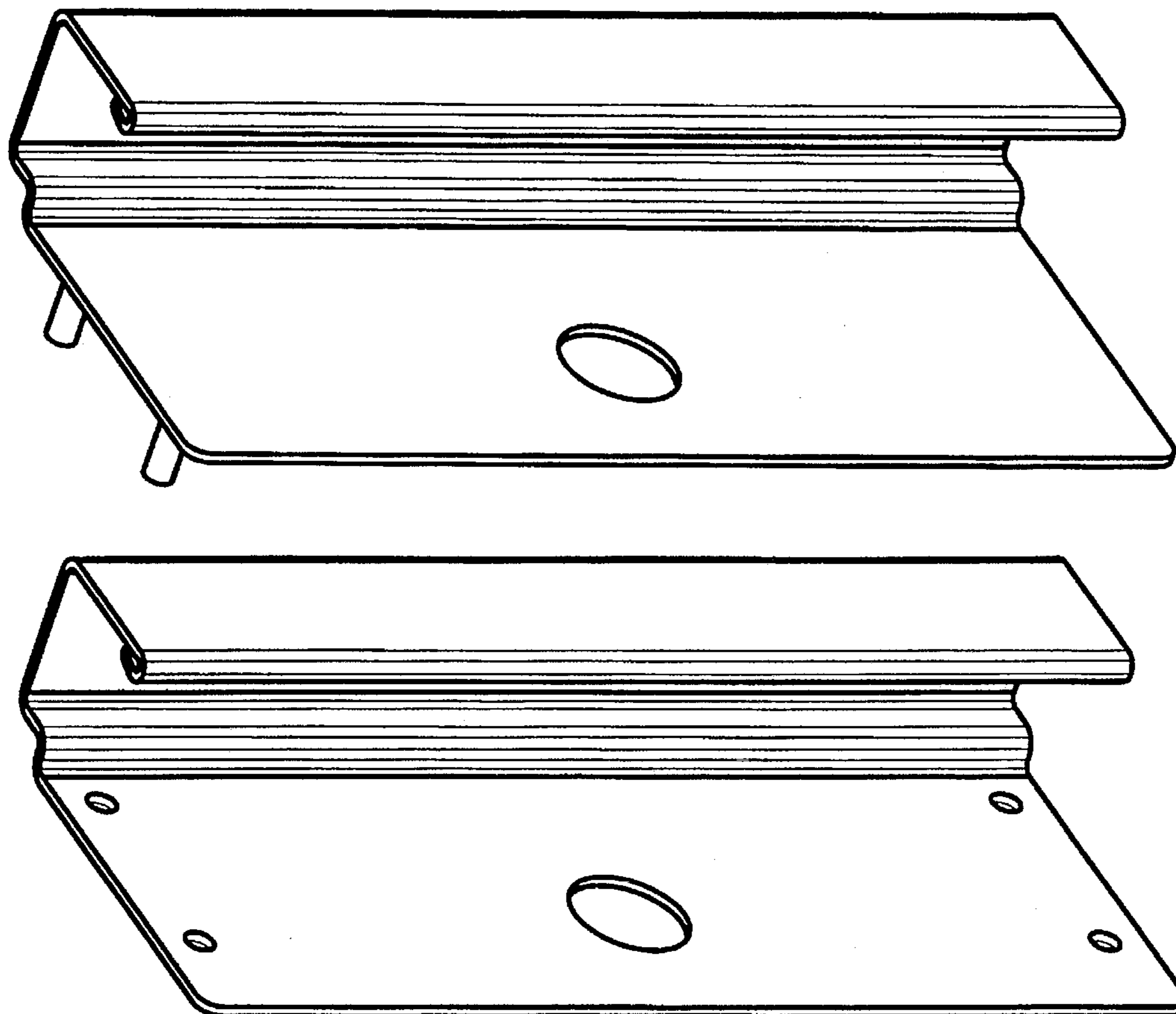

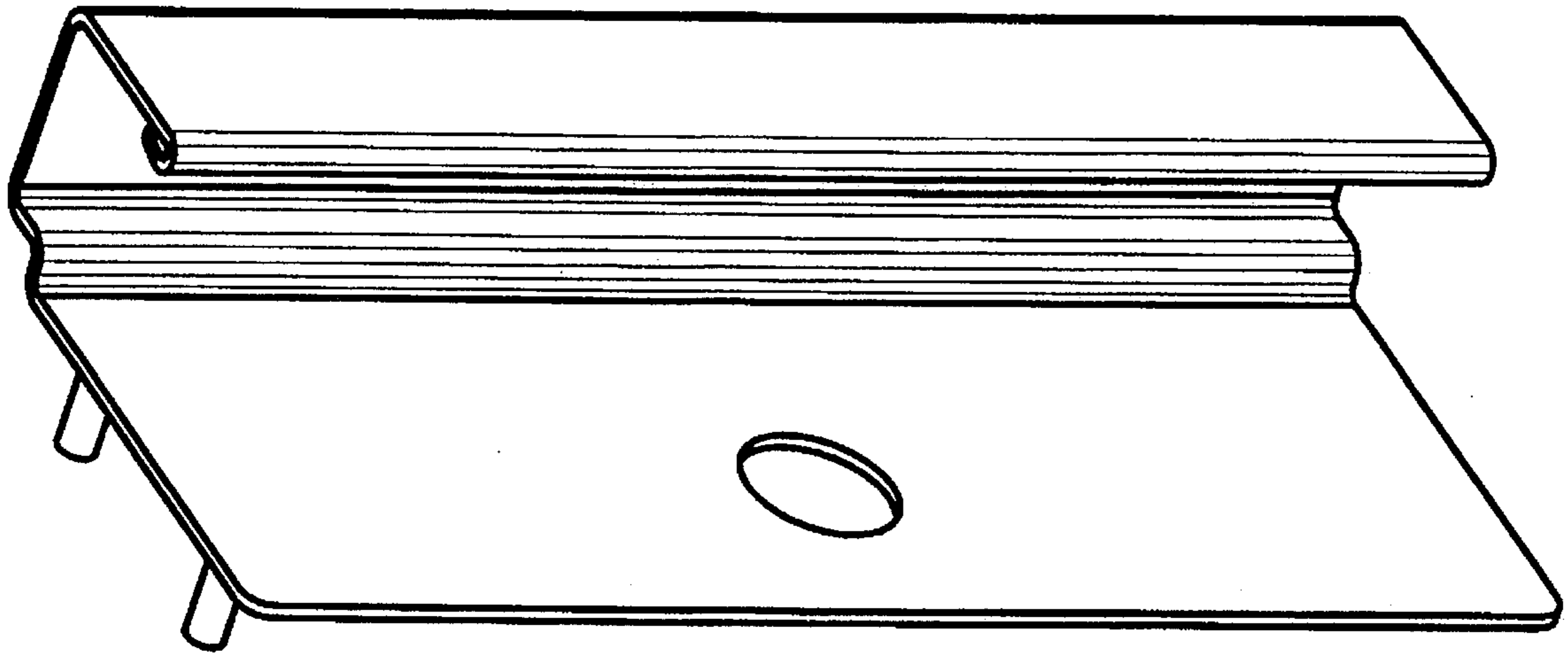

FIG. 1

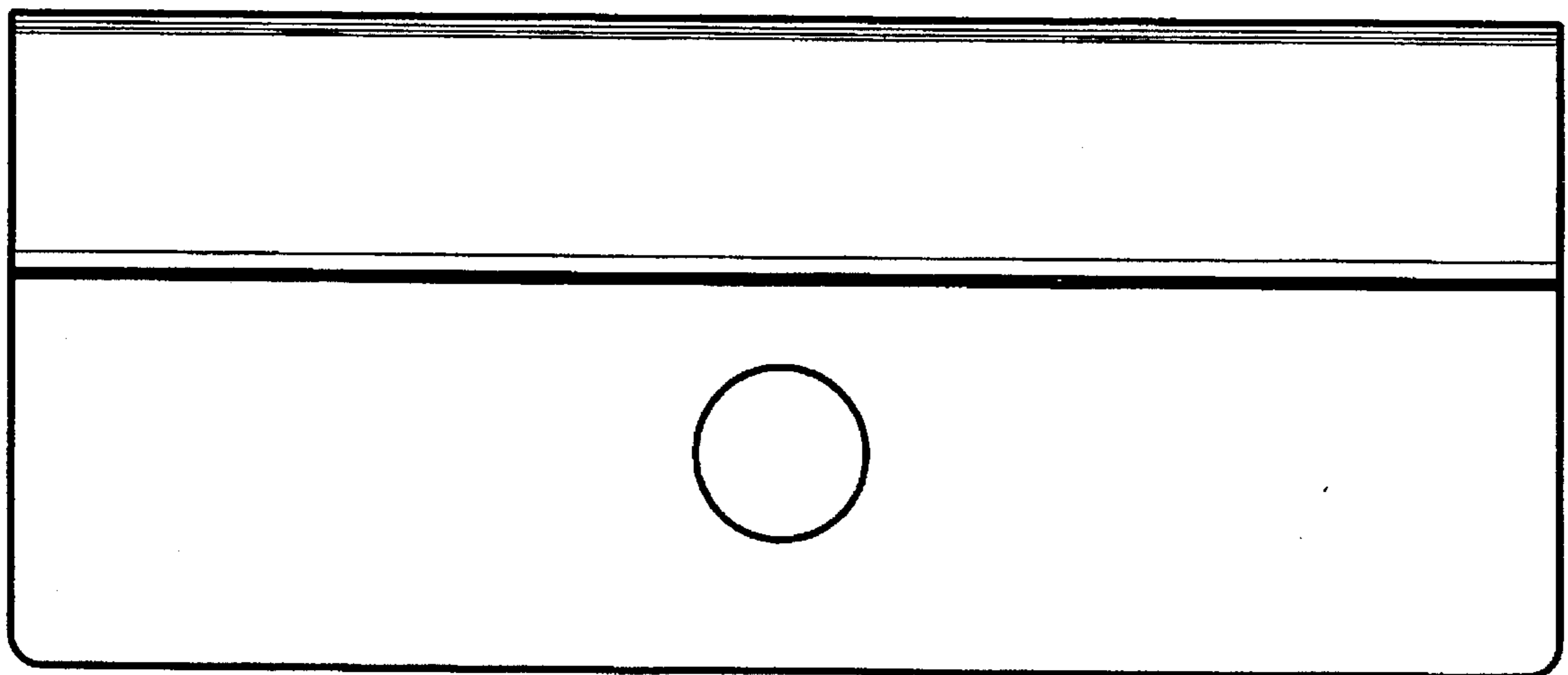

FIG. 2

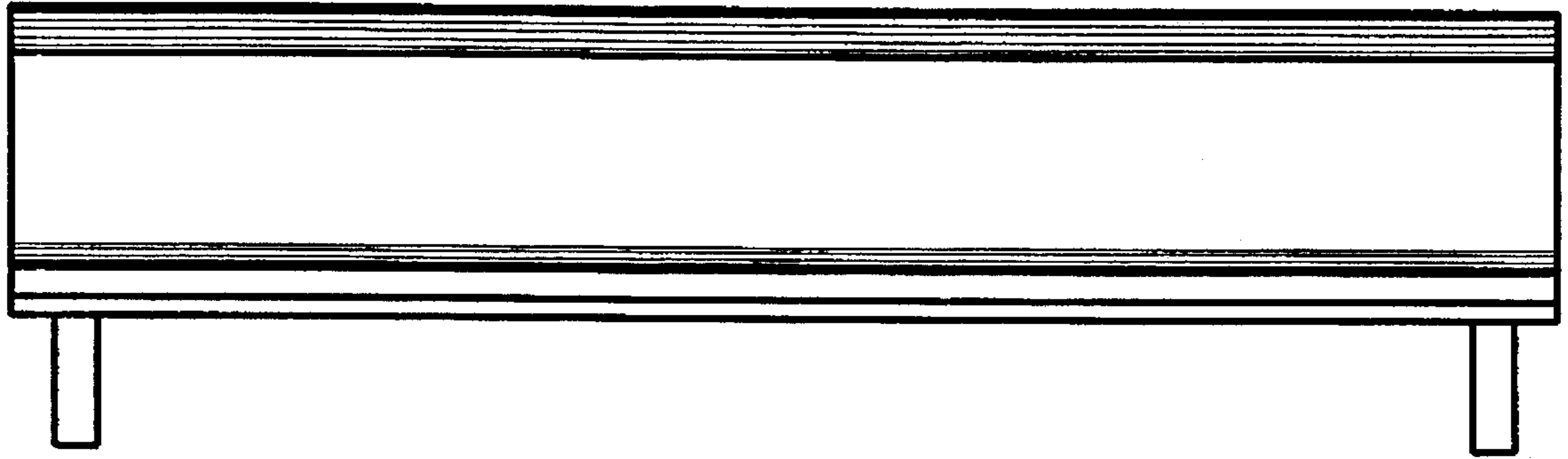

FIG. 3

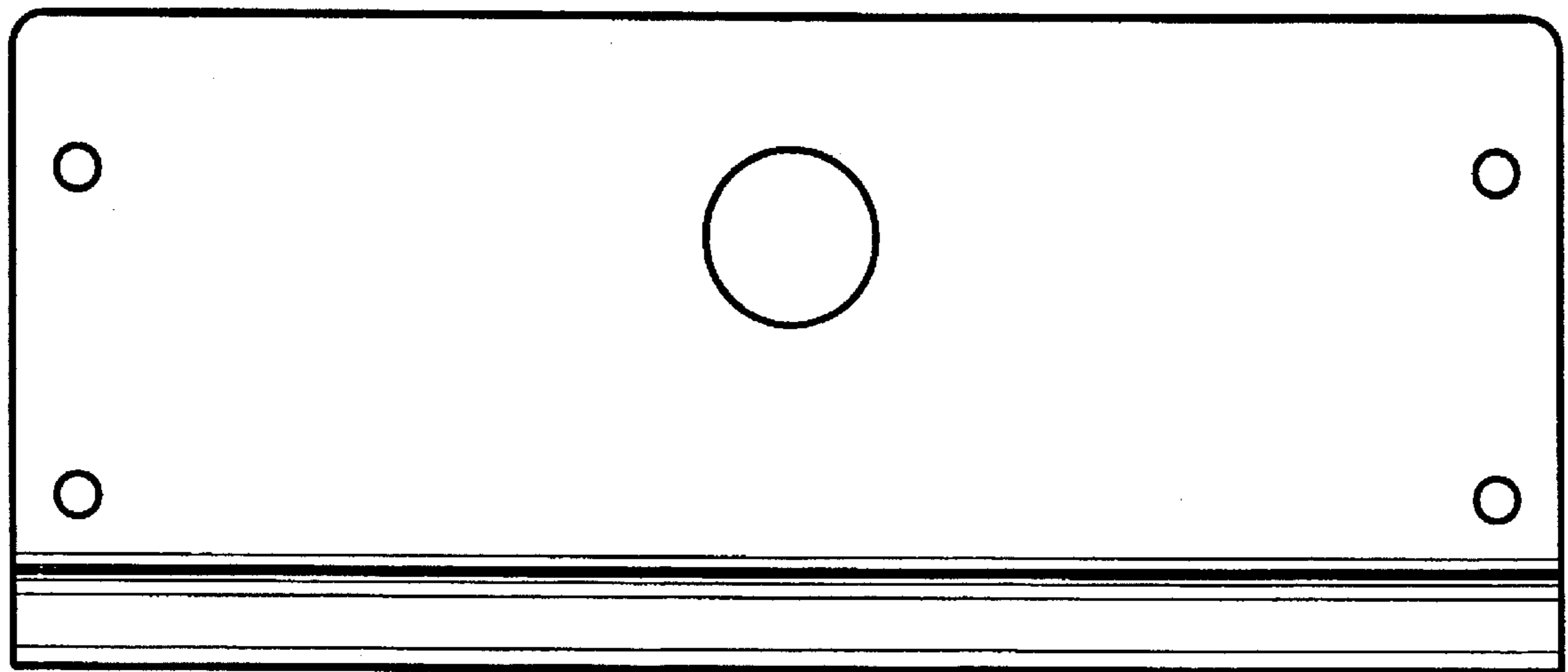

FIG. 4

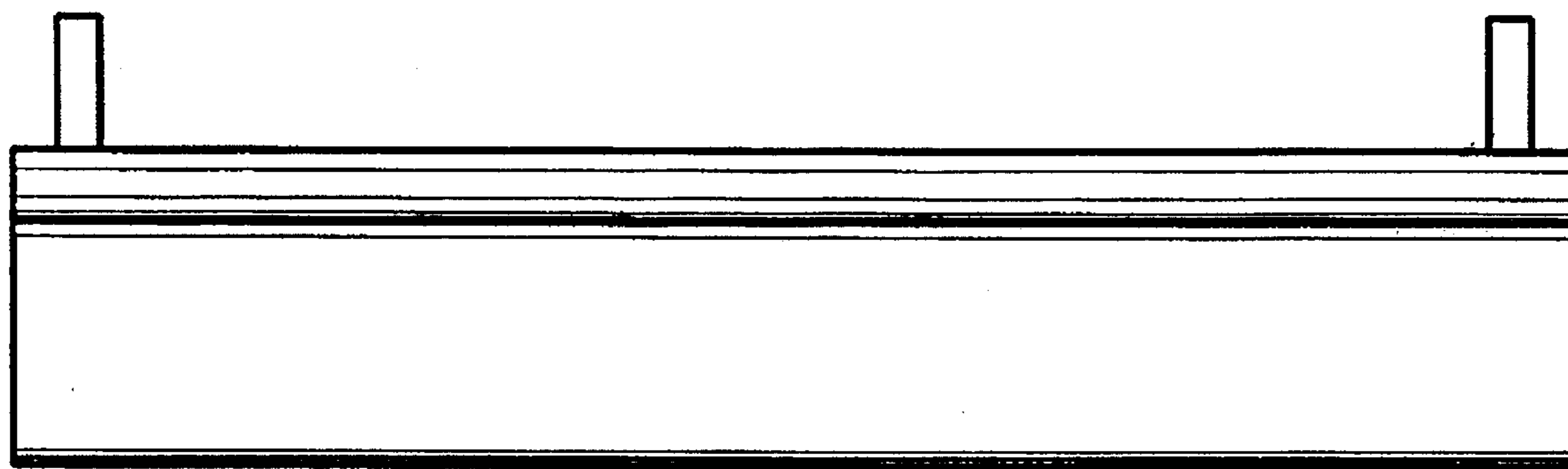

FIG. 5

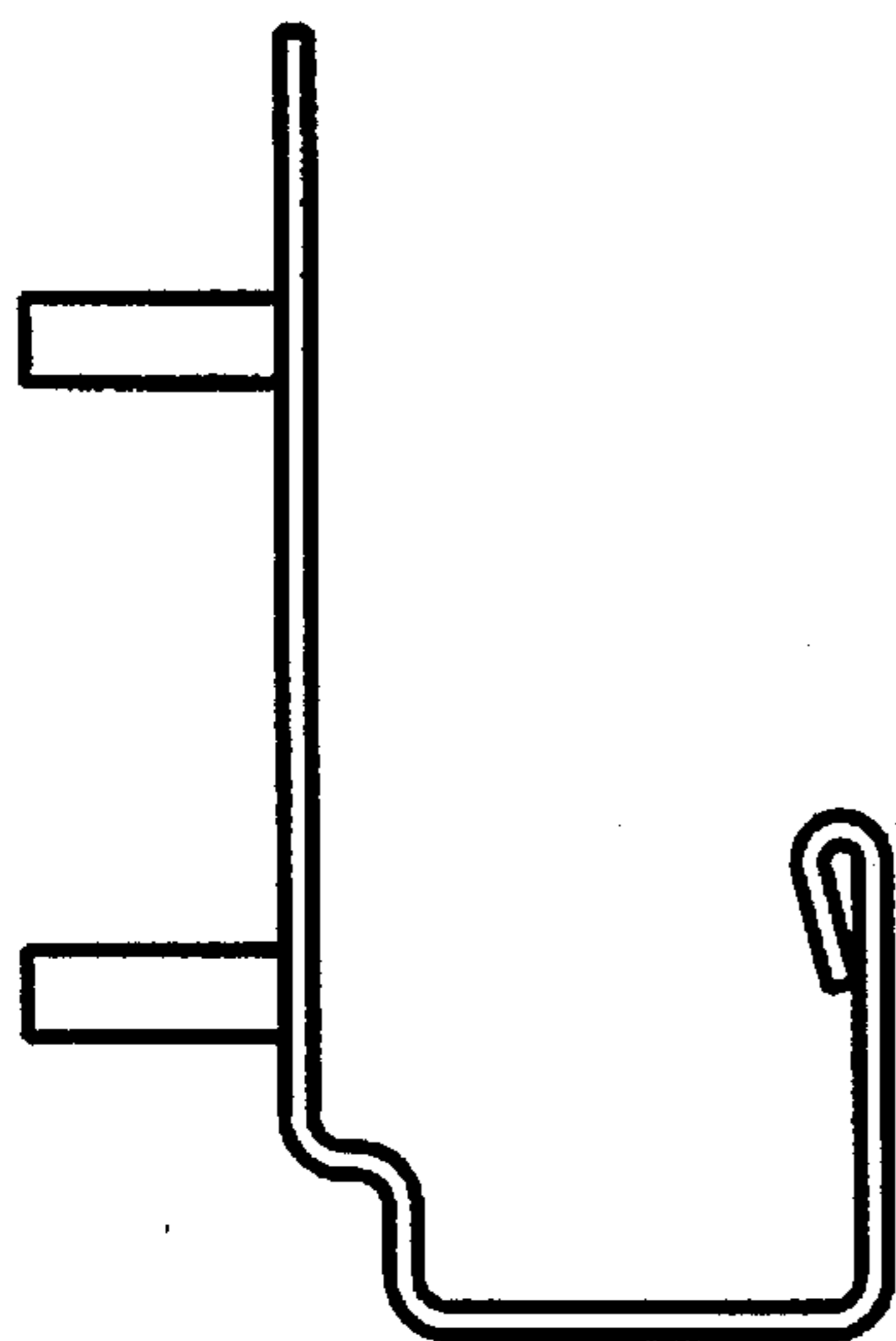

FIG. 7

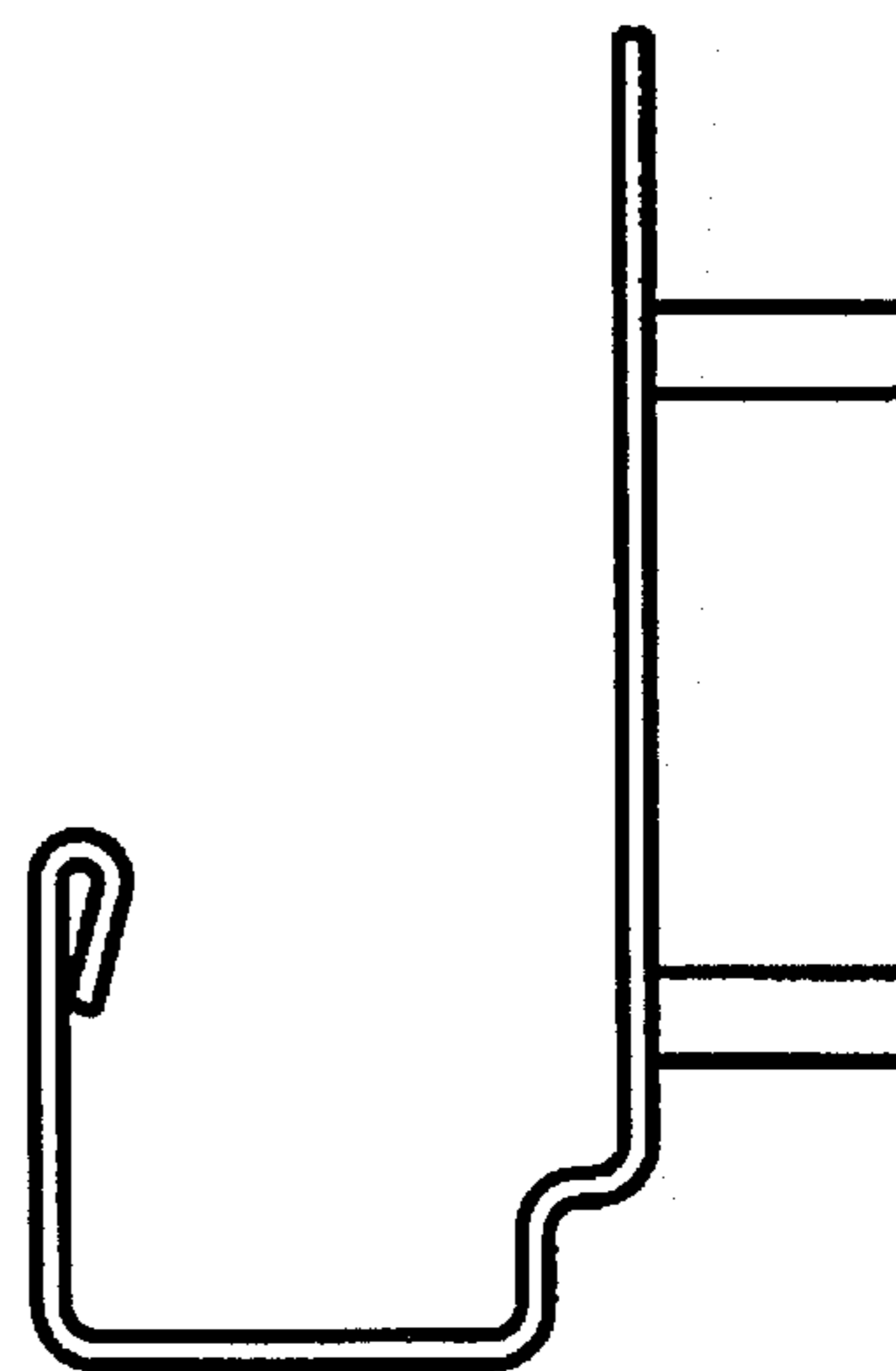

FIG. 6

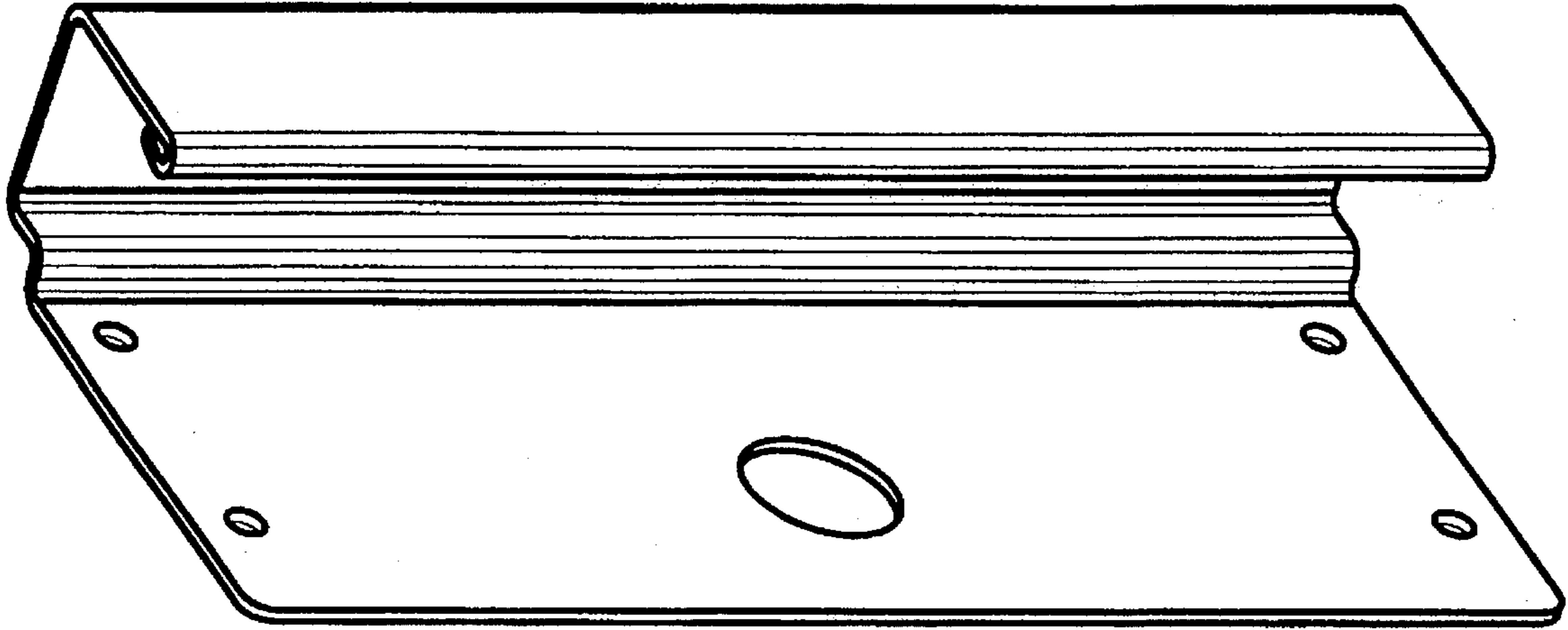

FIG. 8

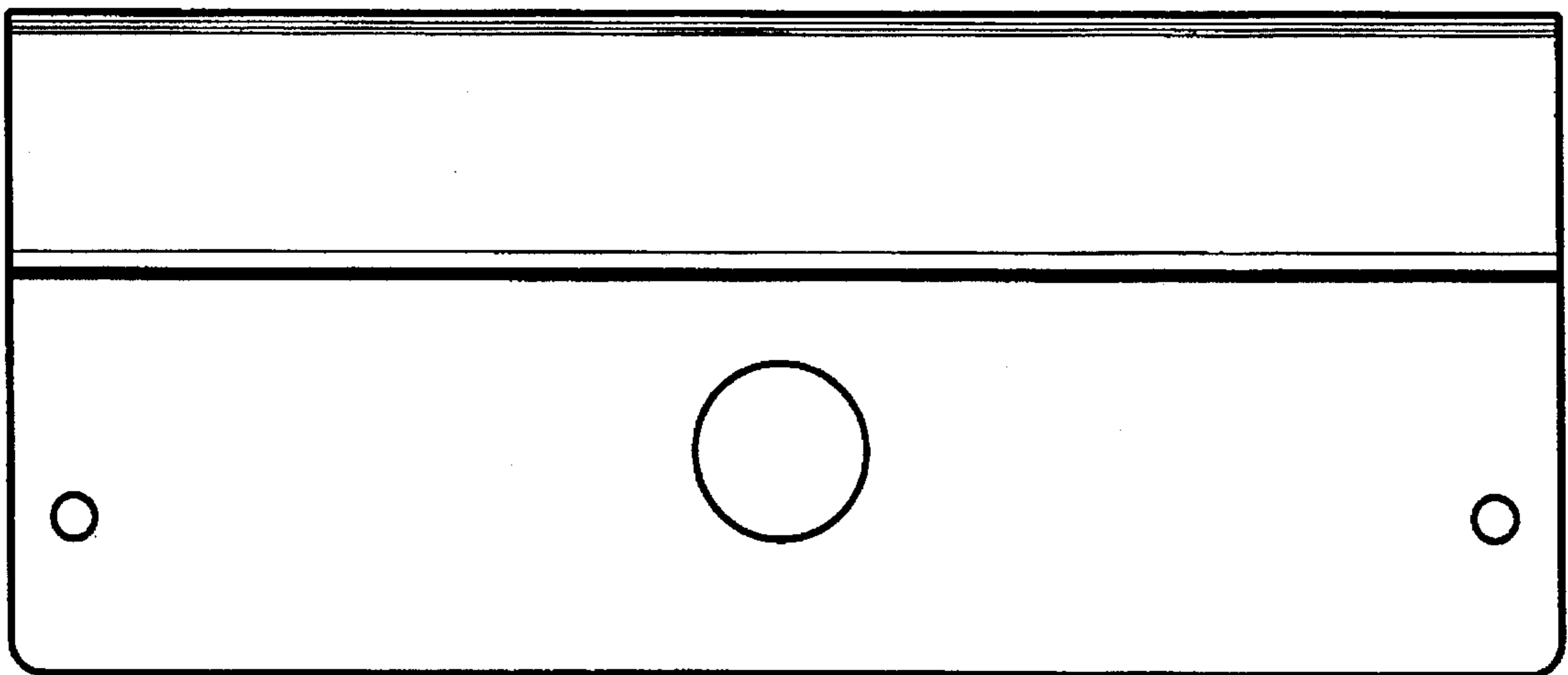

FIG. 9

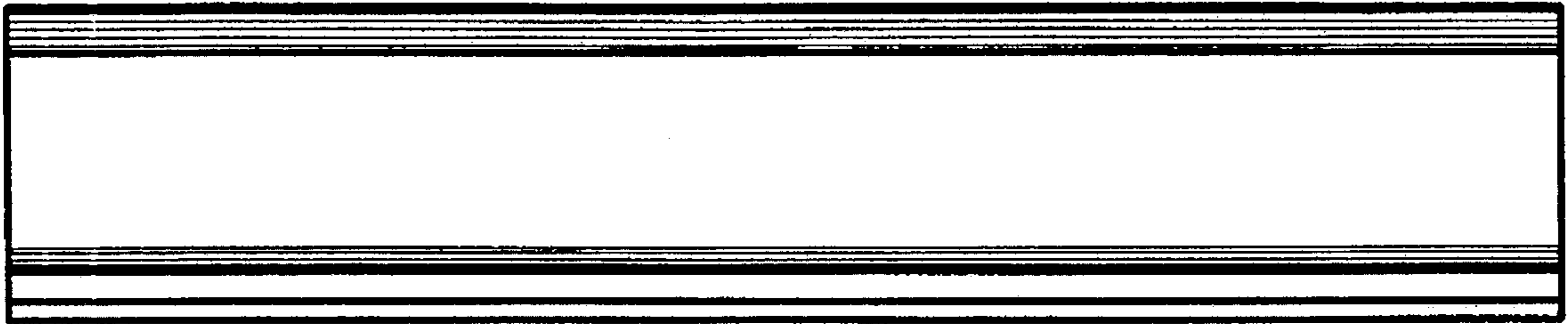

FIG. 10

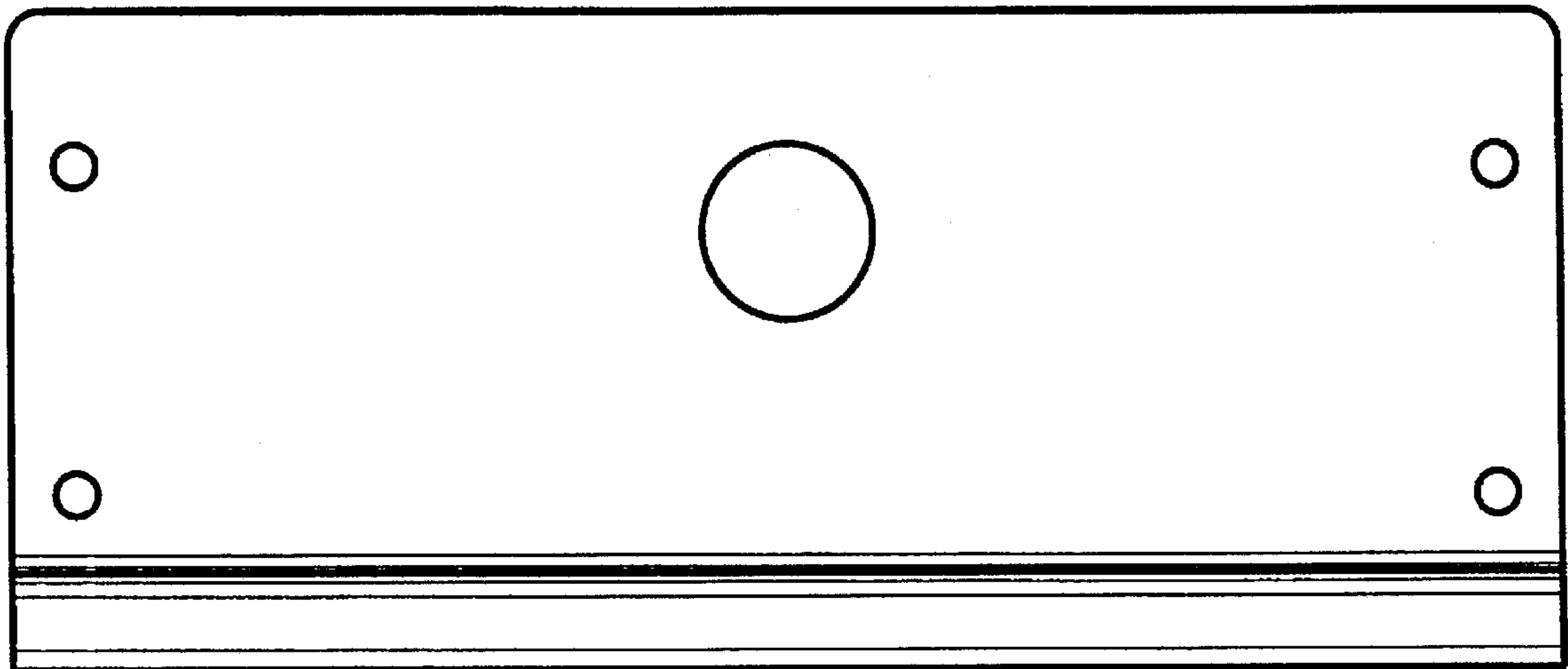

FIG. 11

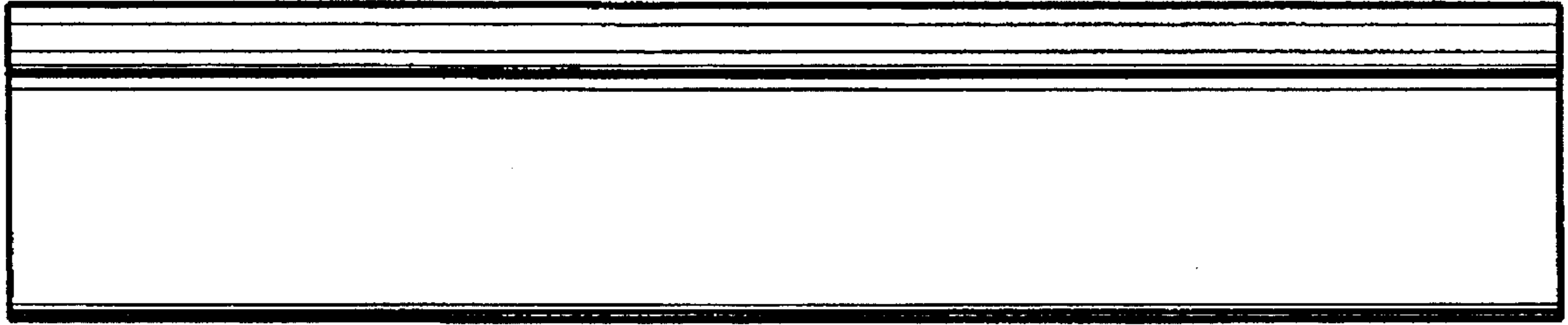

FIG. 12

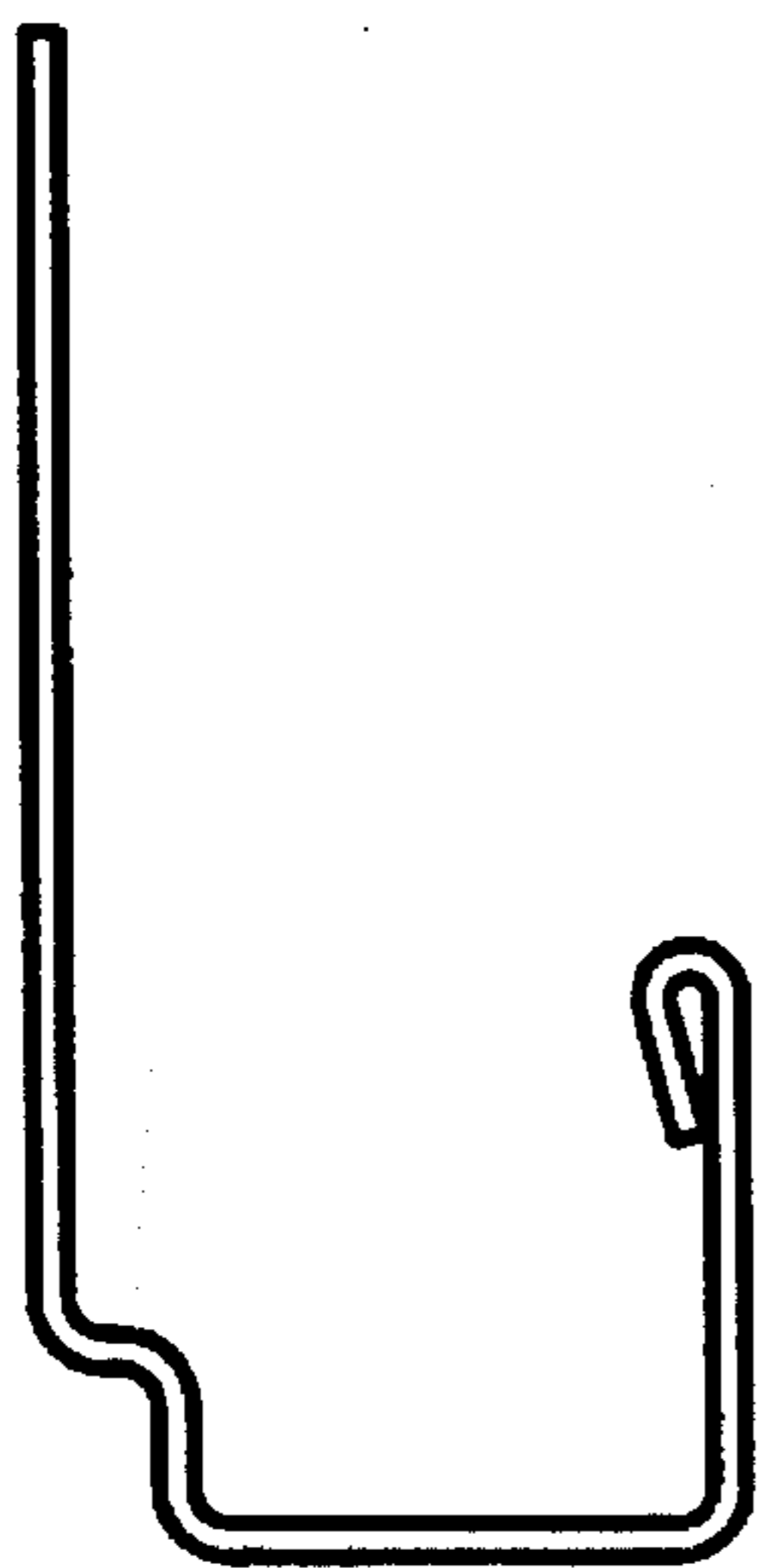

FIG. 14

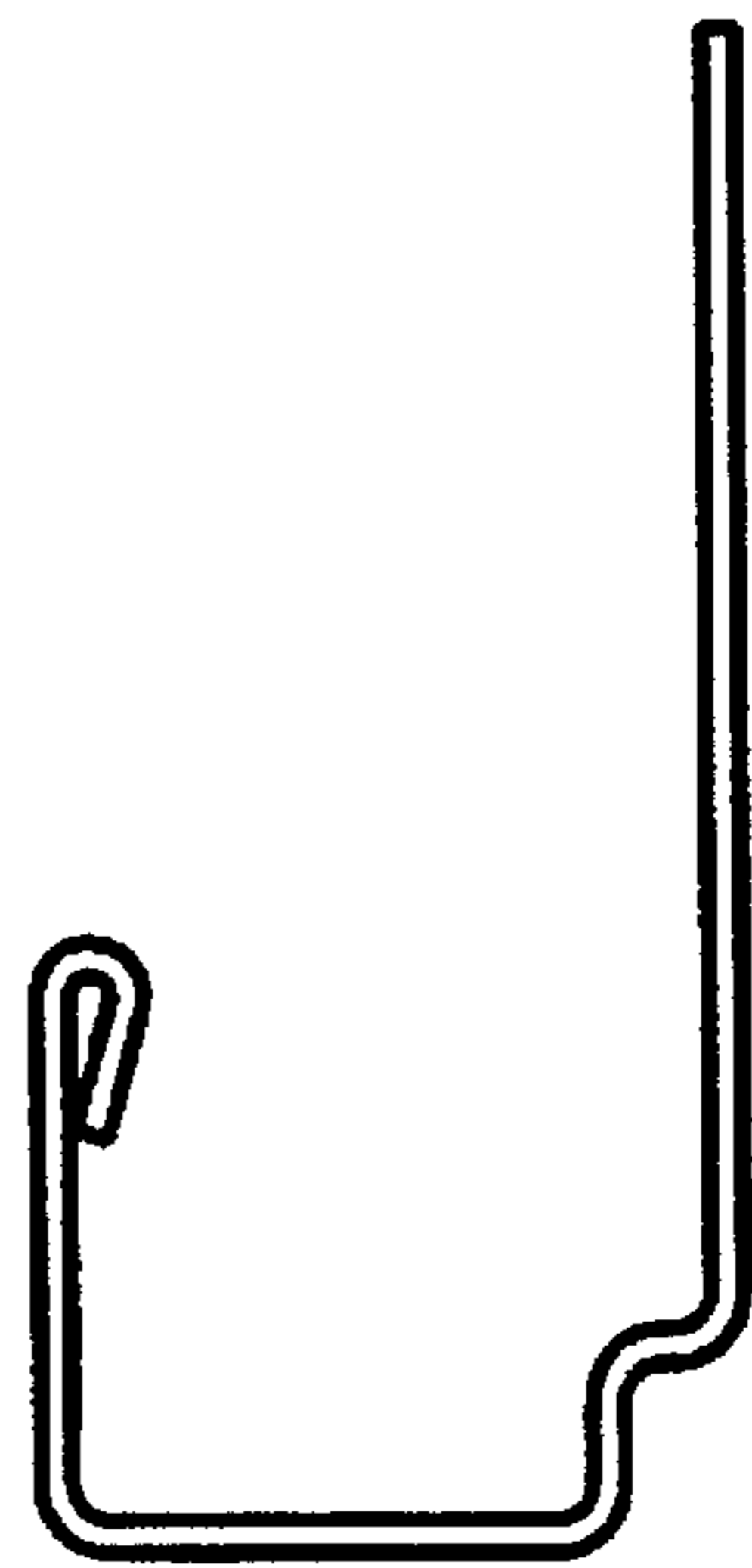

FIG. 13