



US00D375624S

United States Patent [19]
Jensen

[11] **Patent Number: Des. 375,624**

[45] **Date of Patent: **Nov. 19, 1996**

[54] **HOLDER FOR SPRAY CONTAINER**

[76] Inventor: **Eric Jensen**, 7770 Anadale Cir., Lake Worth, Fla. 33467-7710

[**] Term: **14 Years**

[21] Appl. No.: **38,866**

[22] Filed: **May 12, 1995**

[52] U.S. Cl. **D3/229; D3/215**

[58] Field of Search **D3/229, 224, 226, D3/215, 218, 228; 224/218, 219, 179, 221, 222, 267; 2/159, 160, 161, 162, 170**

[56] **References Cited**

U.S. PATENT DOCUMENTS

D. 302,075	7/1989	Burger	D3/218
D. 328,820	8/1992	Davie	D3/228 X
4,477,005	10/1984	Martinez	224/218
4,504,980	3/1985	Butcher	2/160
5,009,347	4/1991	Phelps	224/219
5,088,121	2/1992	Wallace	224/218 X

Primary Examiner—Doris V. Coles
Assistant Examiner—Catherine R. Oliver
Attorney, Agent, or Firm—Quarles & Brady

[57] **CLAIM**

The design for a holder for spray container, as shown and described.

DESCRIPTION

FIG. 1 is a perspective view of my new design;
FIG. 2 is a perspective view of the design in an alternative configuration, showing a spray container in phantom;
FIG. 3 is a front elevation of the configuration of FIG. 2;
FIG. 4 is a rear elevation;
FIG. 5 is a right side elevation;
FIG. 6 is a left side elevation;
FIG. 7 is a bottom view; and,
FIG. 8 is a top plan view.

The broken line showing of a spray can in FIG. 2 is for illustrative purposes only and forms no part of the claimed design.

1 Claim, 3 Drawing Sheets

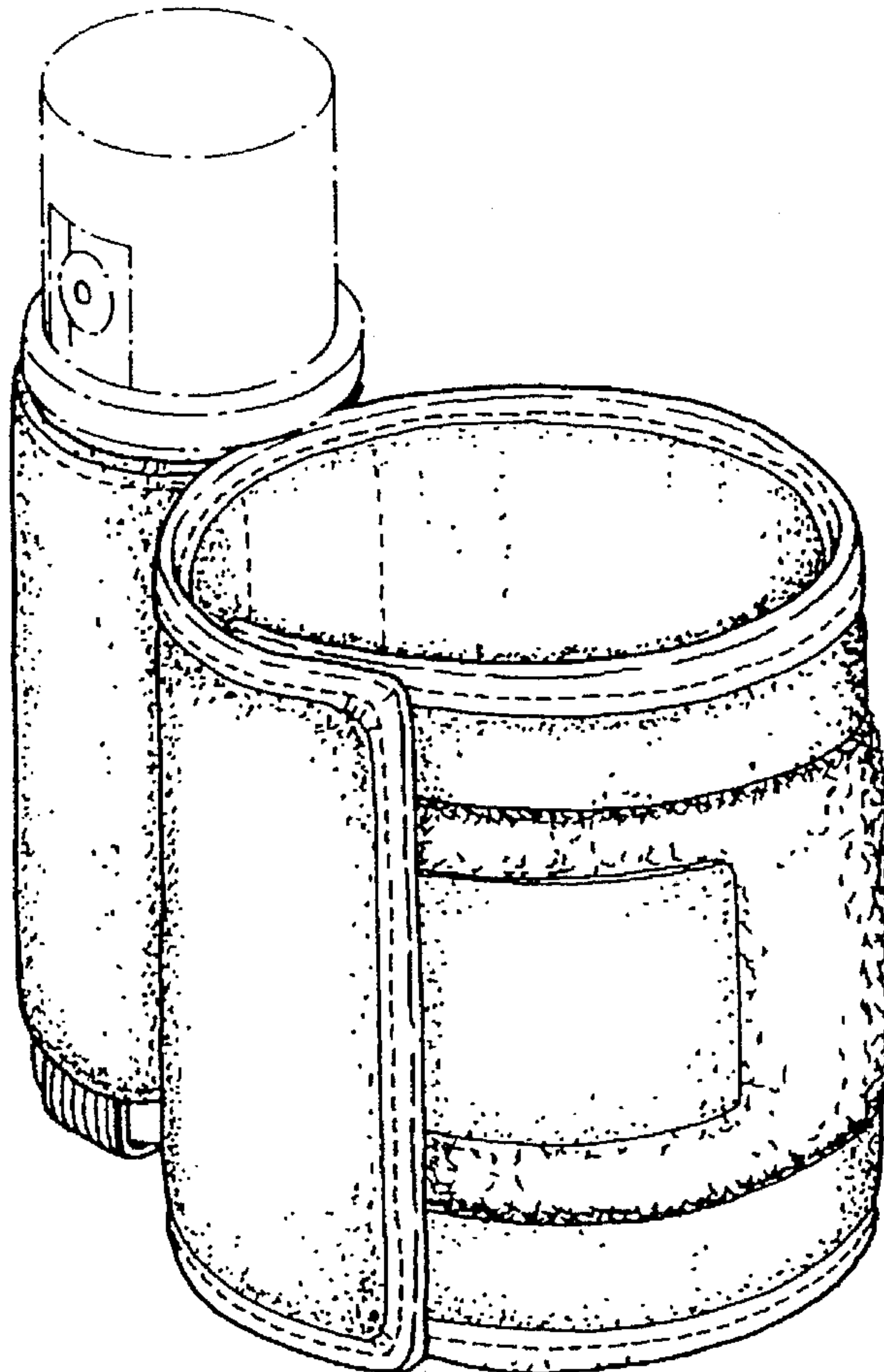

FIG. 1

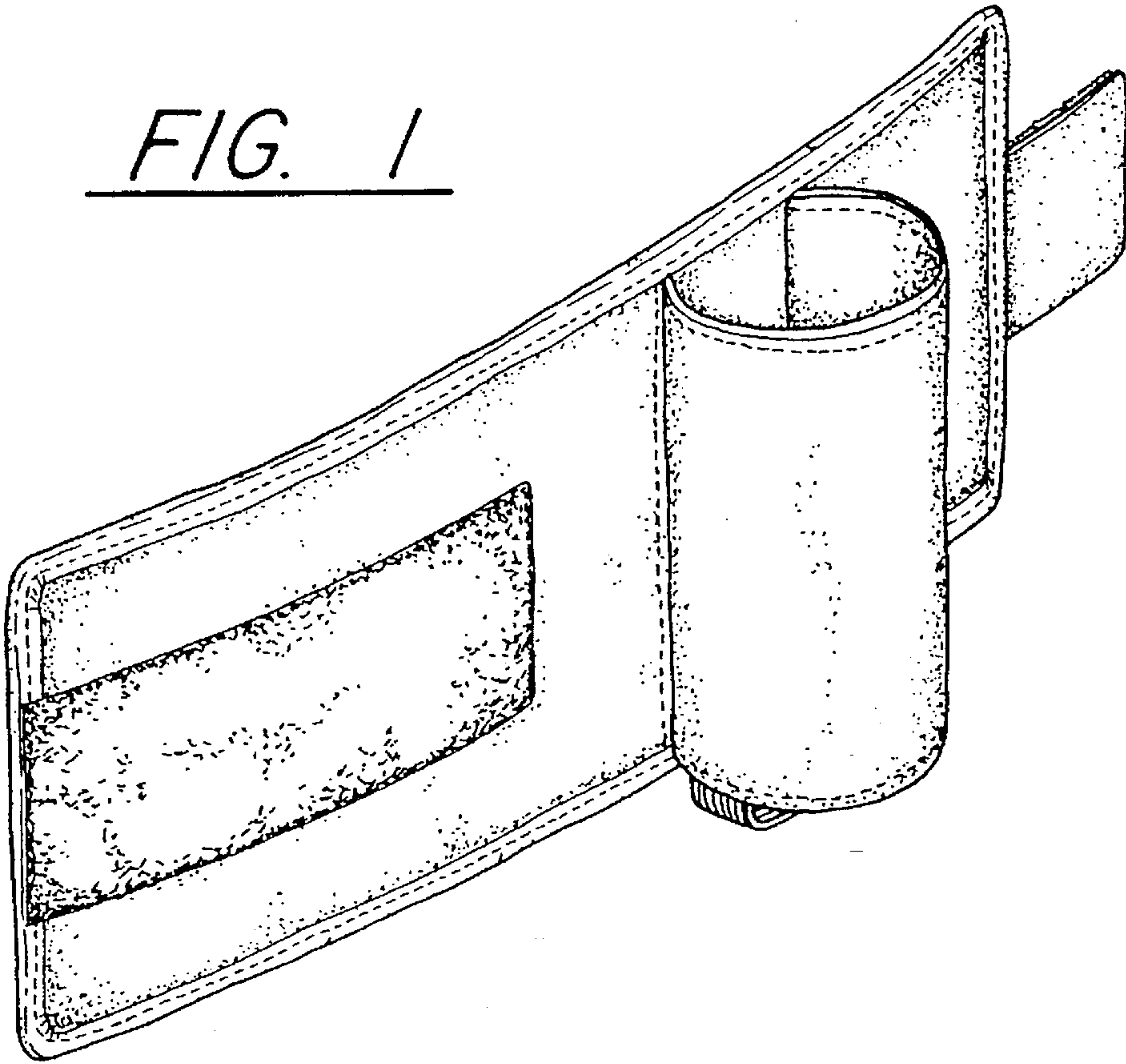

FIG. 2

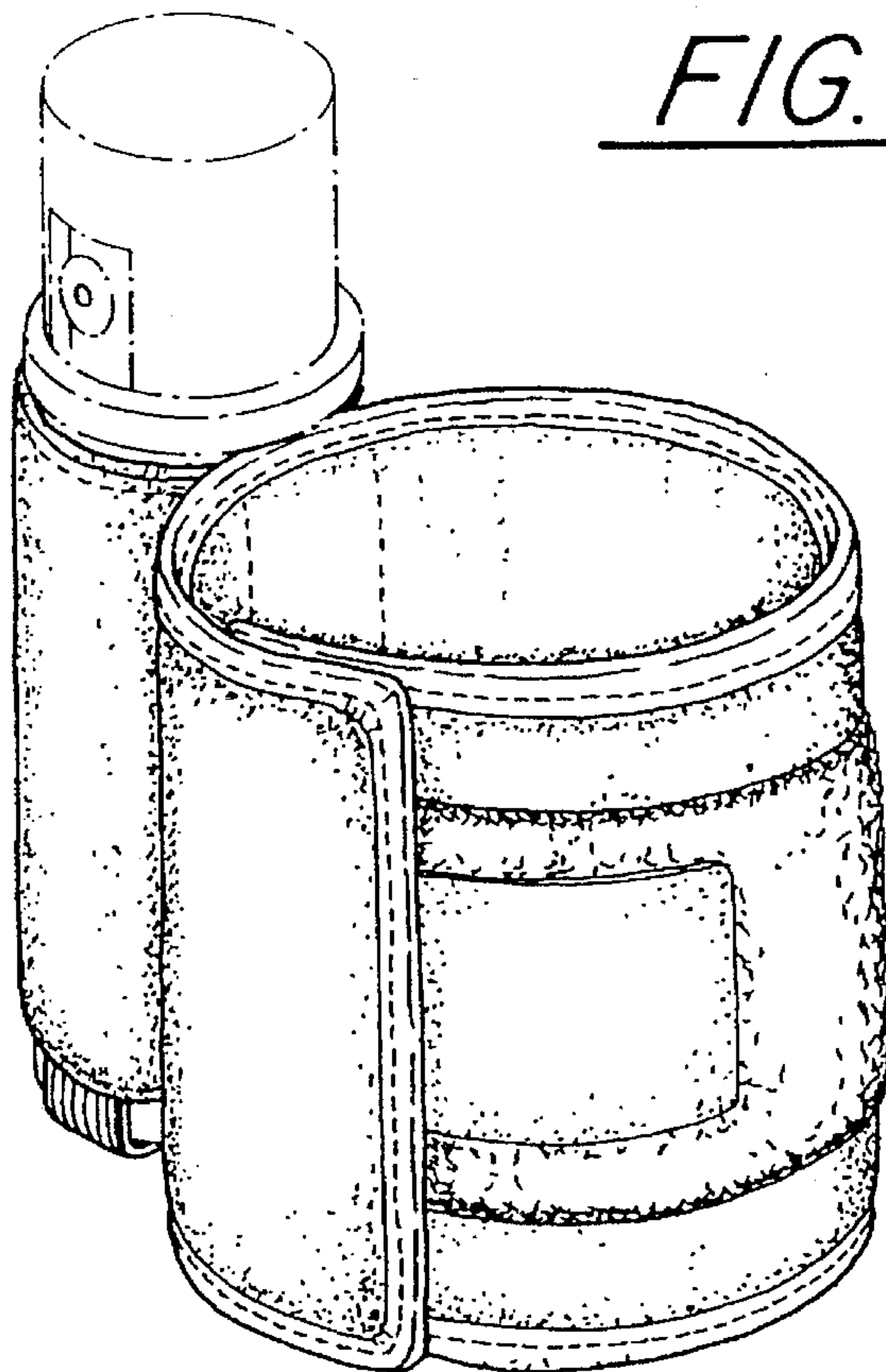

FIG. 3

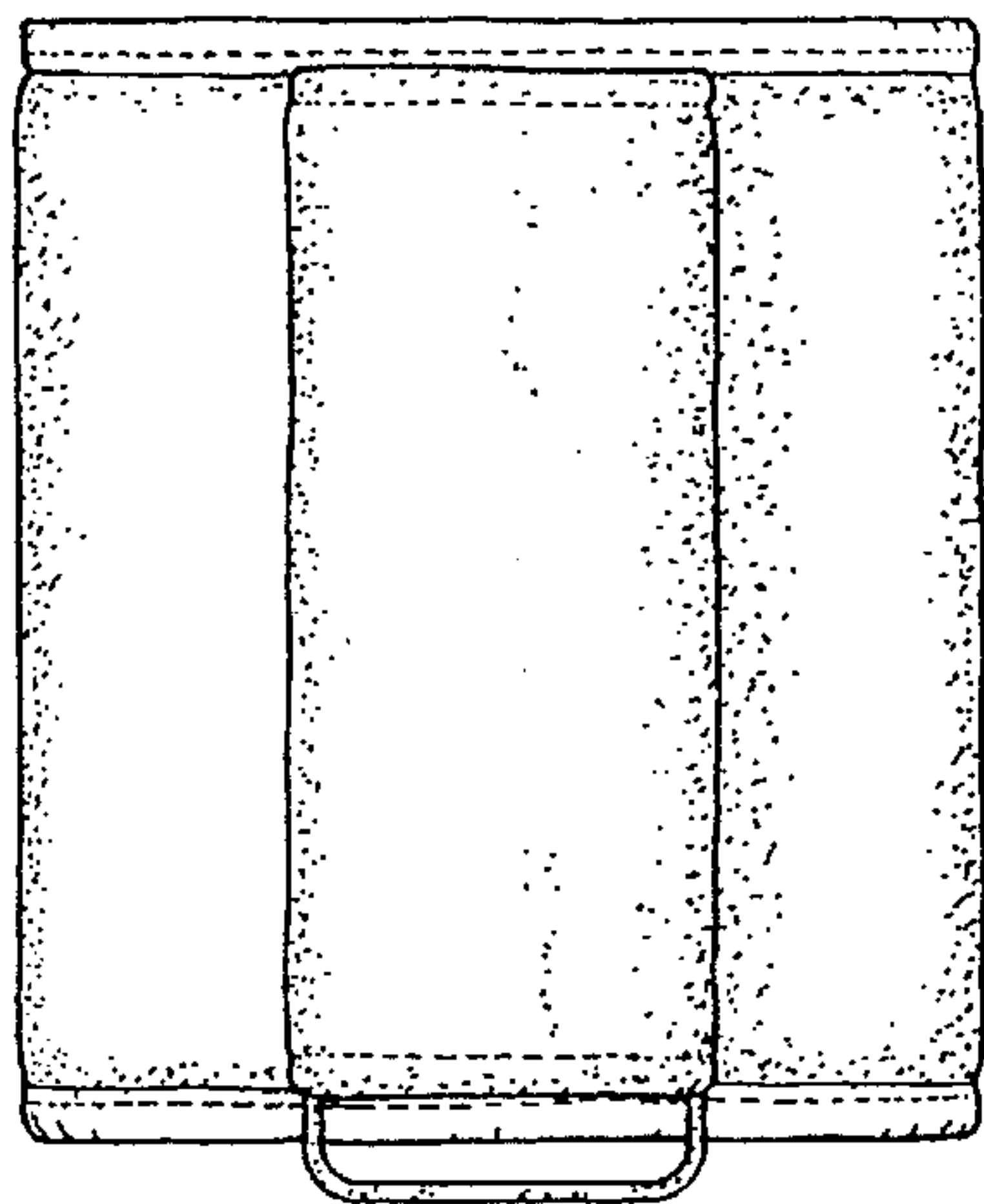

FIG. 4

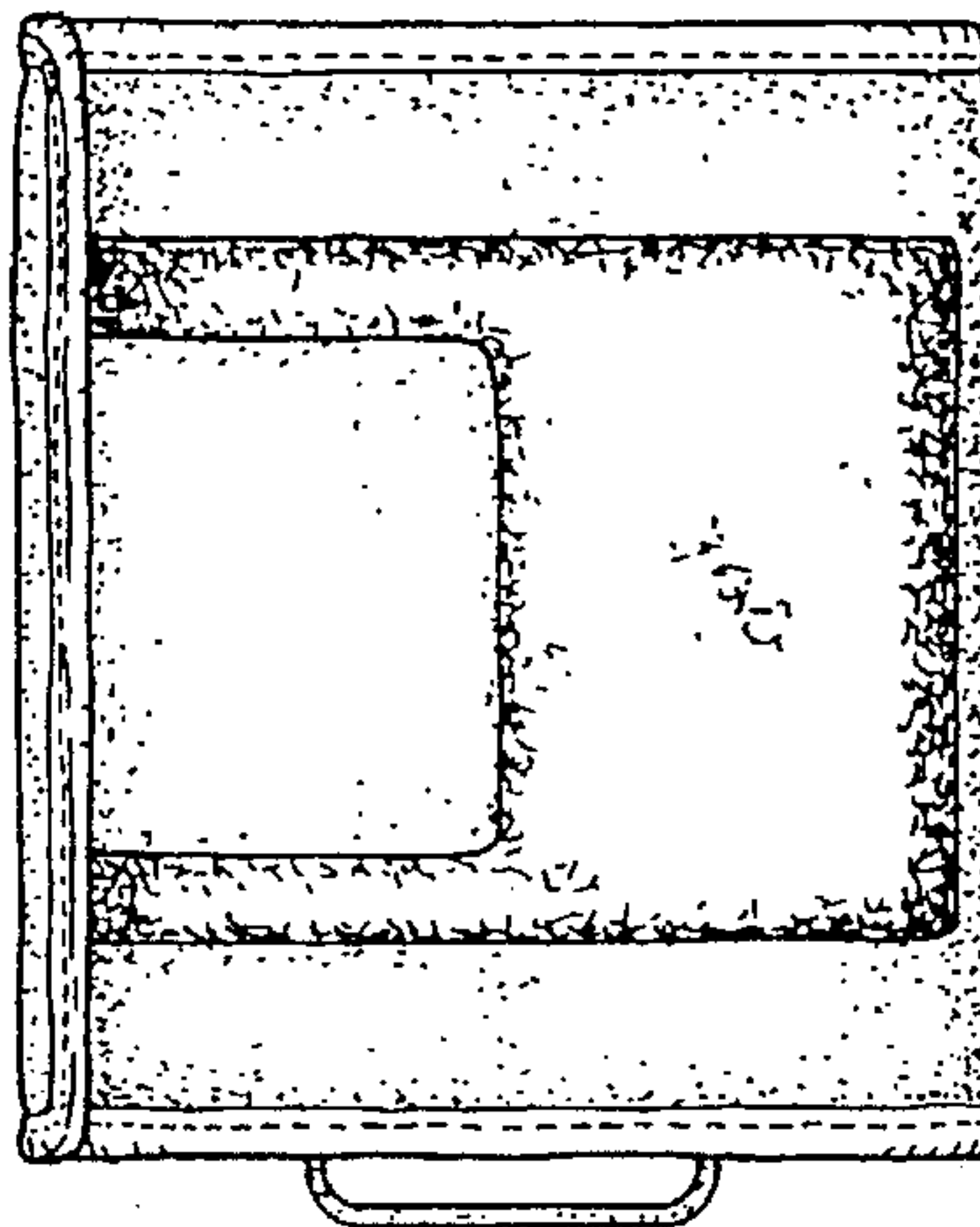

FIG. 5

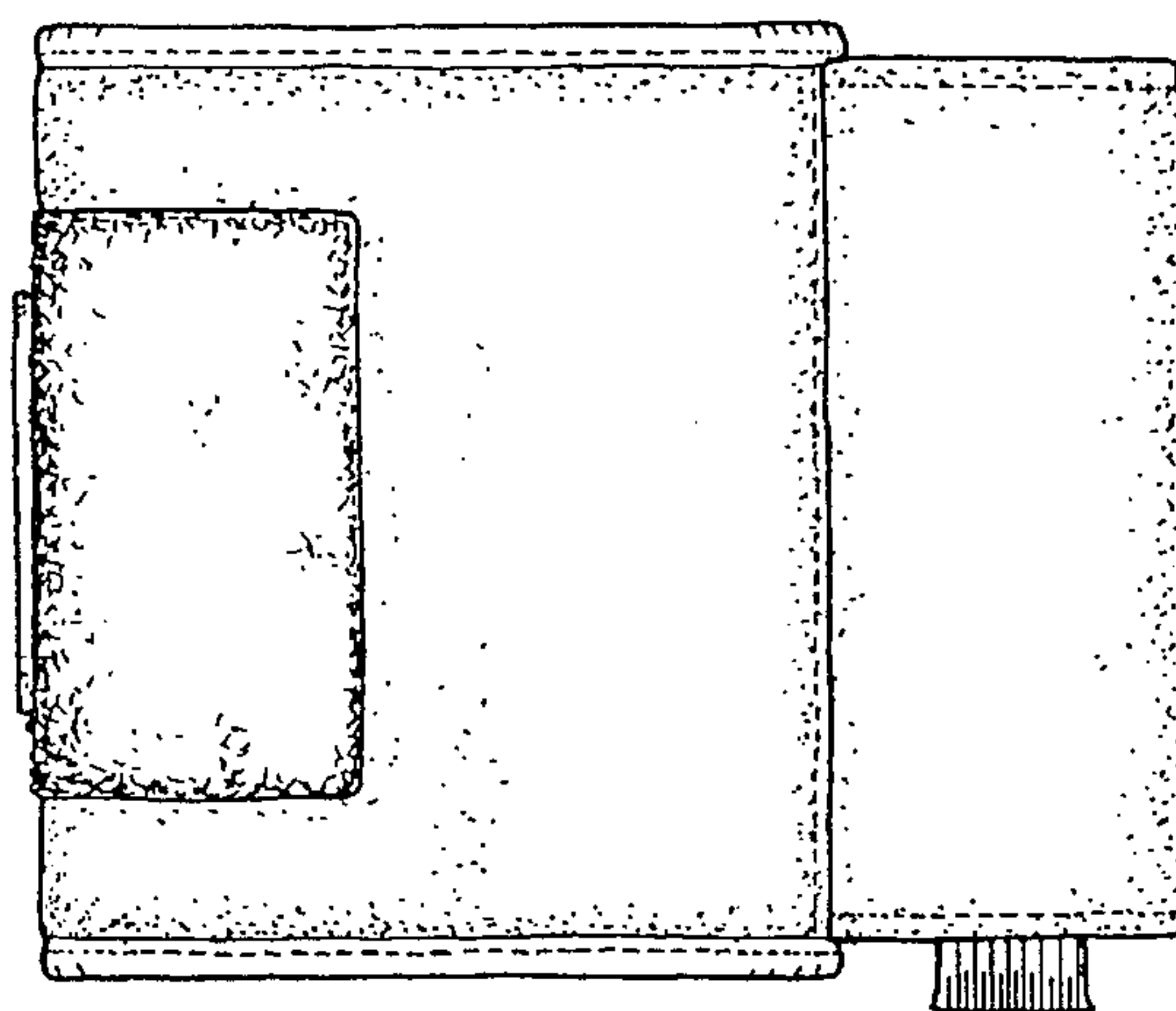
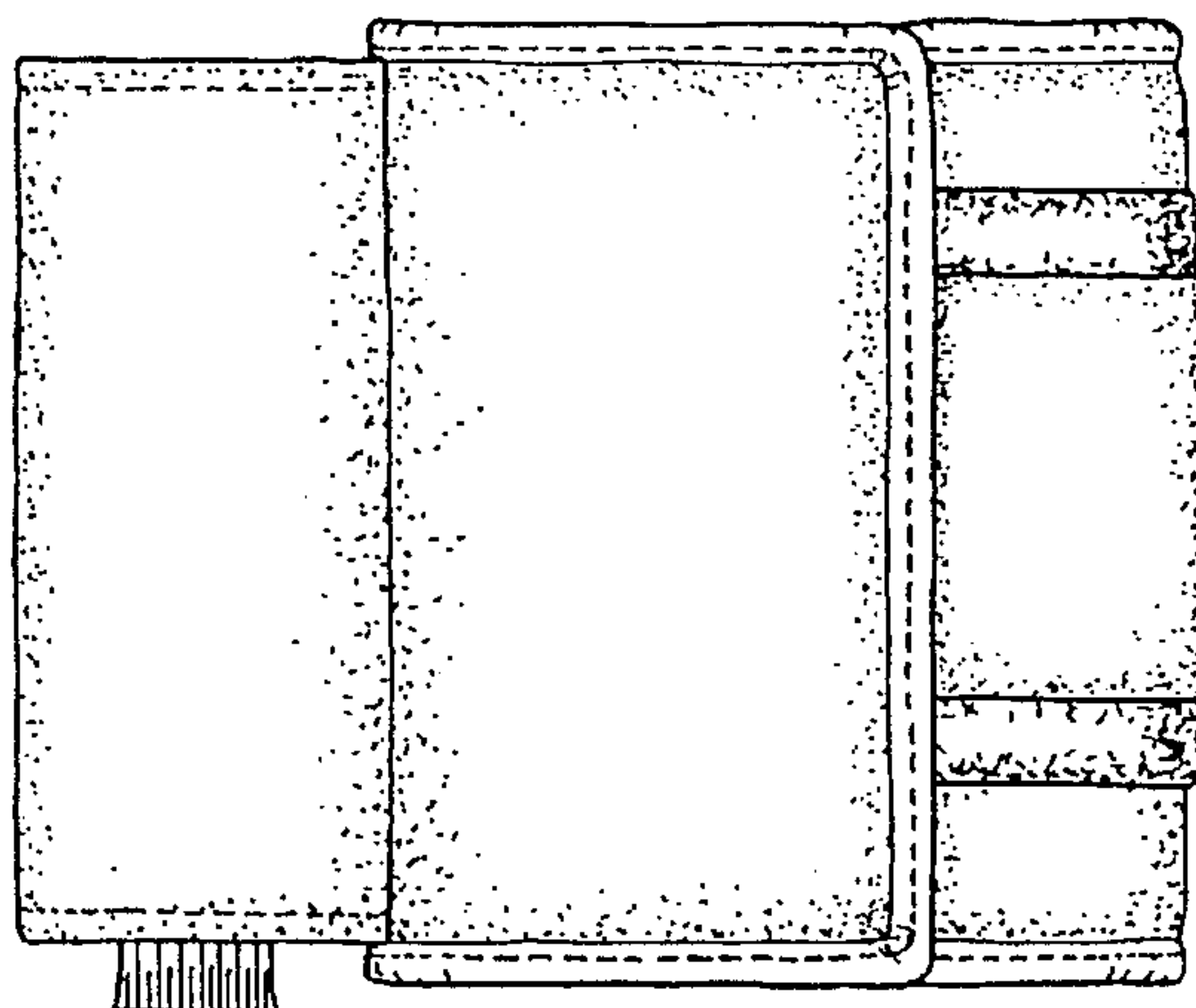

FIG. 6



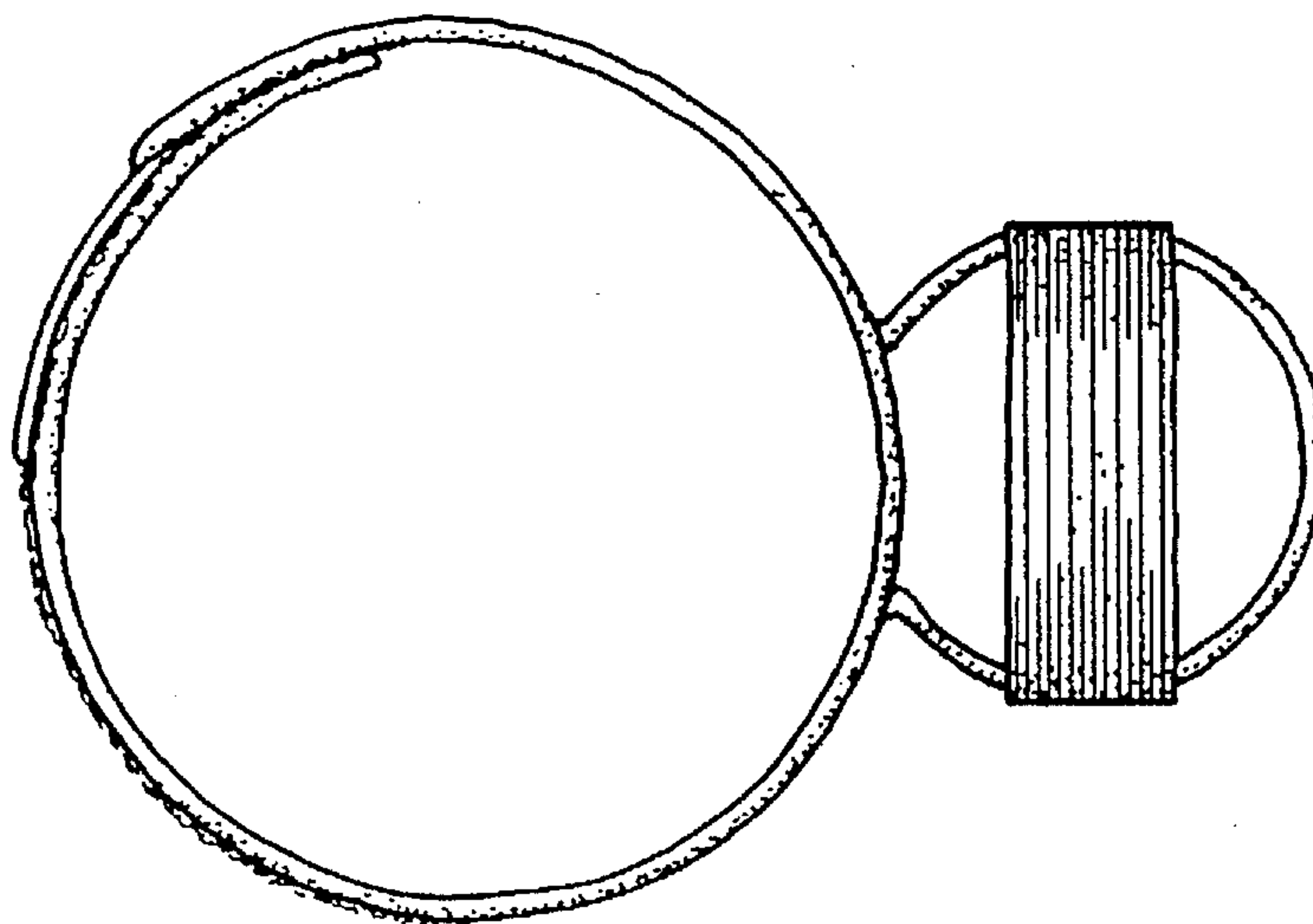

FIG. 7

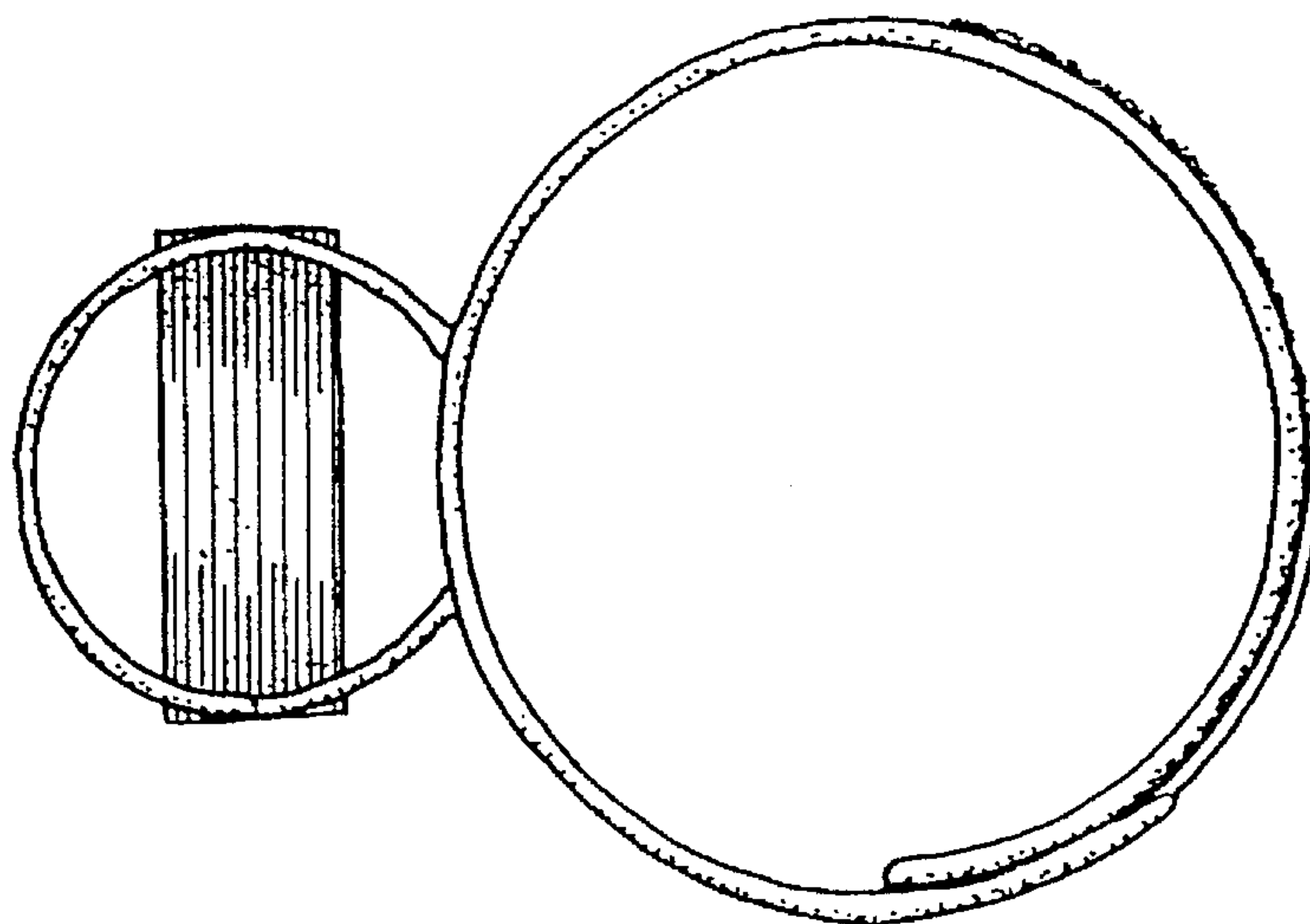

FIG. 8