



US00D375599S

# United States Patent [19]

Hirano et al.

[11] Patent Number: **Des. 375,599**

[45] Date of Patent: **\*\*Nov. 12, 1996**

[54] **STRUCTURAL PIPE**

5,456,048 10/1995 White ..... 403/174

[75] Inventors: **Seiji Hirano; Shuji Yoshino**, both of Shizuoka, Japan

*Primary Examiner*—Kay H. Chin  
*Attorney, Agent, or Firm*—Eric P. Schellin

[73] Assignee: **Yazaki Industrial Chemical Co., Ltd.**, Shizuoka, Japan

[57] **CLAIM**

[\*\*] Term: **14 Years**

The ornamental design for a structural pipe, as shown and described.

[21] Appl. No.: **41,566**

### DESCRIPTION

[22] Filed: **Jul. 18, 1995**

[52] U.S. Cl. .... **D34/27; D25/122; D25/61; D23/266**

[58] **Field of Search** ..... **D34/27; 280/33.992; D23/266; D25/122, 124, 119, 164, 61; 403/174, 191, 245, 272; 52/81.2, 664, 731.3; 138/157**

FIG. 1 is a top, front, right side perspective view of a structural pipe showing our new design;  
FIG. 2 is a front elevational view;  
FIG. 3 is a right side elevational view;  
FIG. 4 is a left side elevational view;  
FIG. 5 is a top plan view;  
FIG. 6 is a bottom plan view;  
FIG. 7 is a cross sectional view taken on line VII—VII of FIG. 2; and,  
FIG. 8 is a reduced perspective view, the broken line showing of pipes, wires, plates and wheels, the full line showing of the structural pipes and additional structural pipes being for illustrative purposes only.

### [56] **References Cited**

#### U.S. PATENT DOCUMENTS

21,076	9/1981	Milliken .....	D23/266
2,980,215	4/1961	Englund .....	D25/122
2,990,203	6/1961	Grover et al. ....	D25/122

**1 Claim, 3 Drawing Sheets**

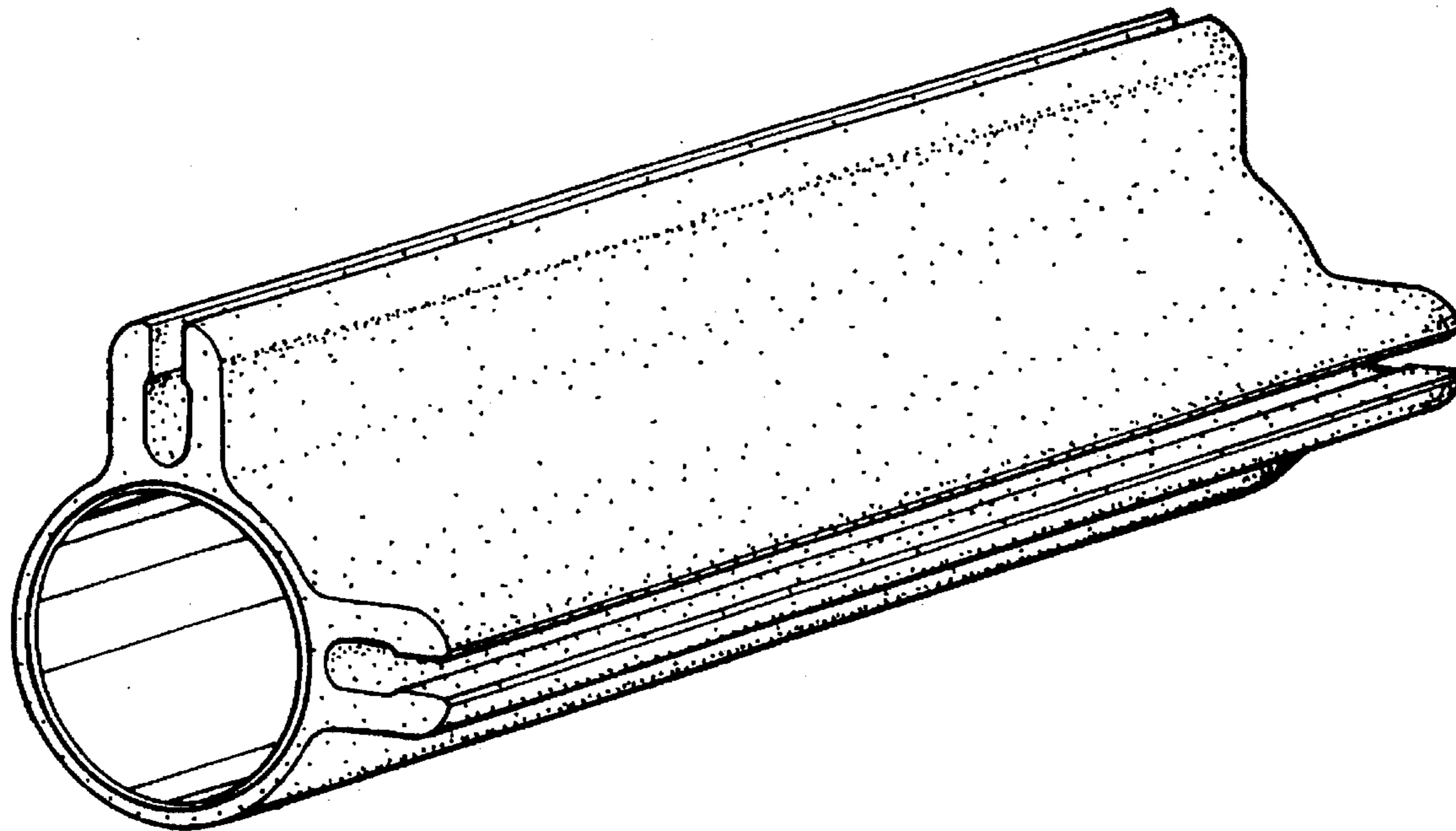

FIG. 1

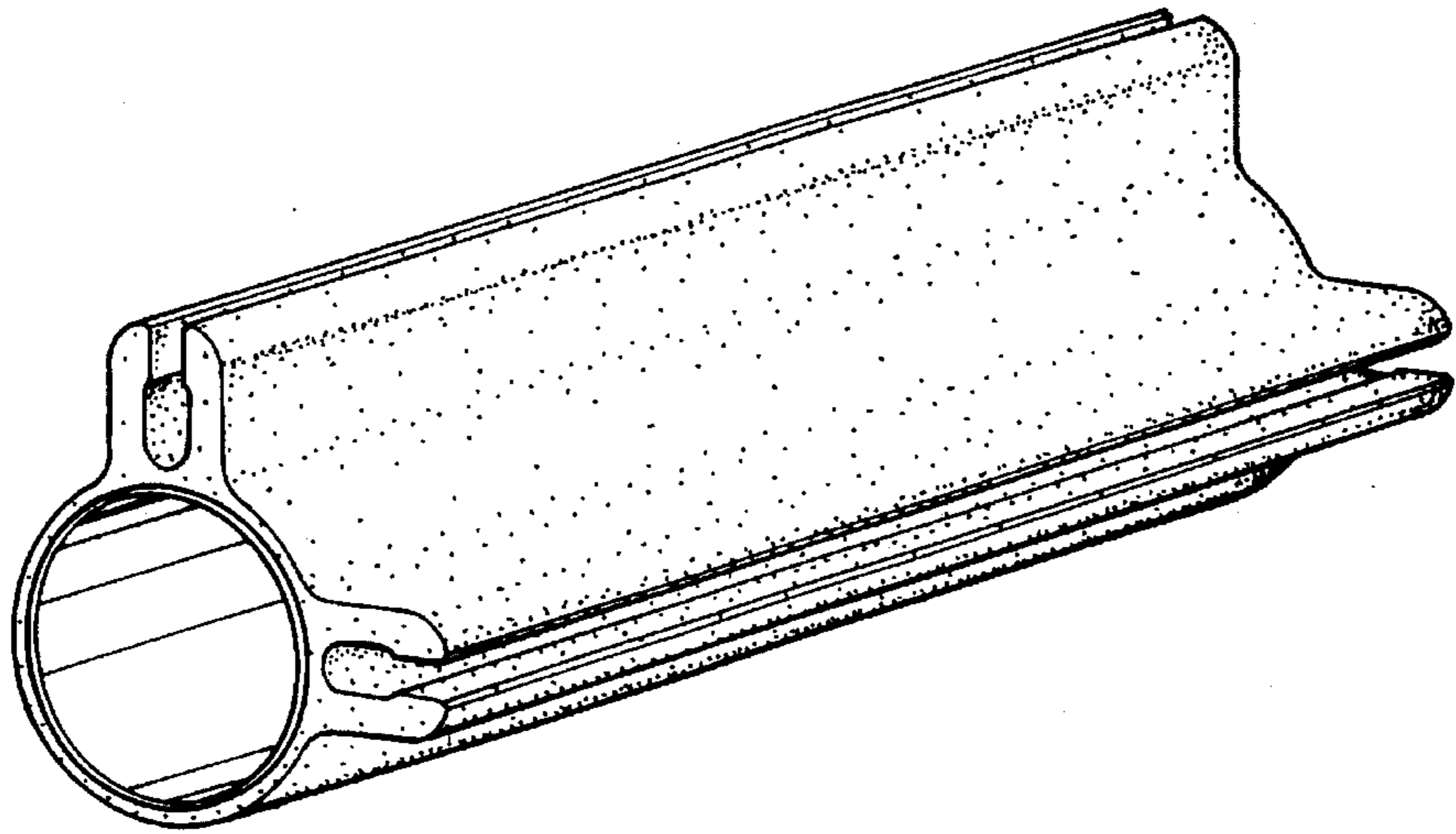

FIG. 2

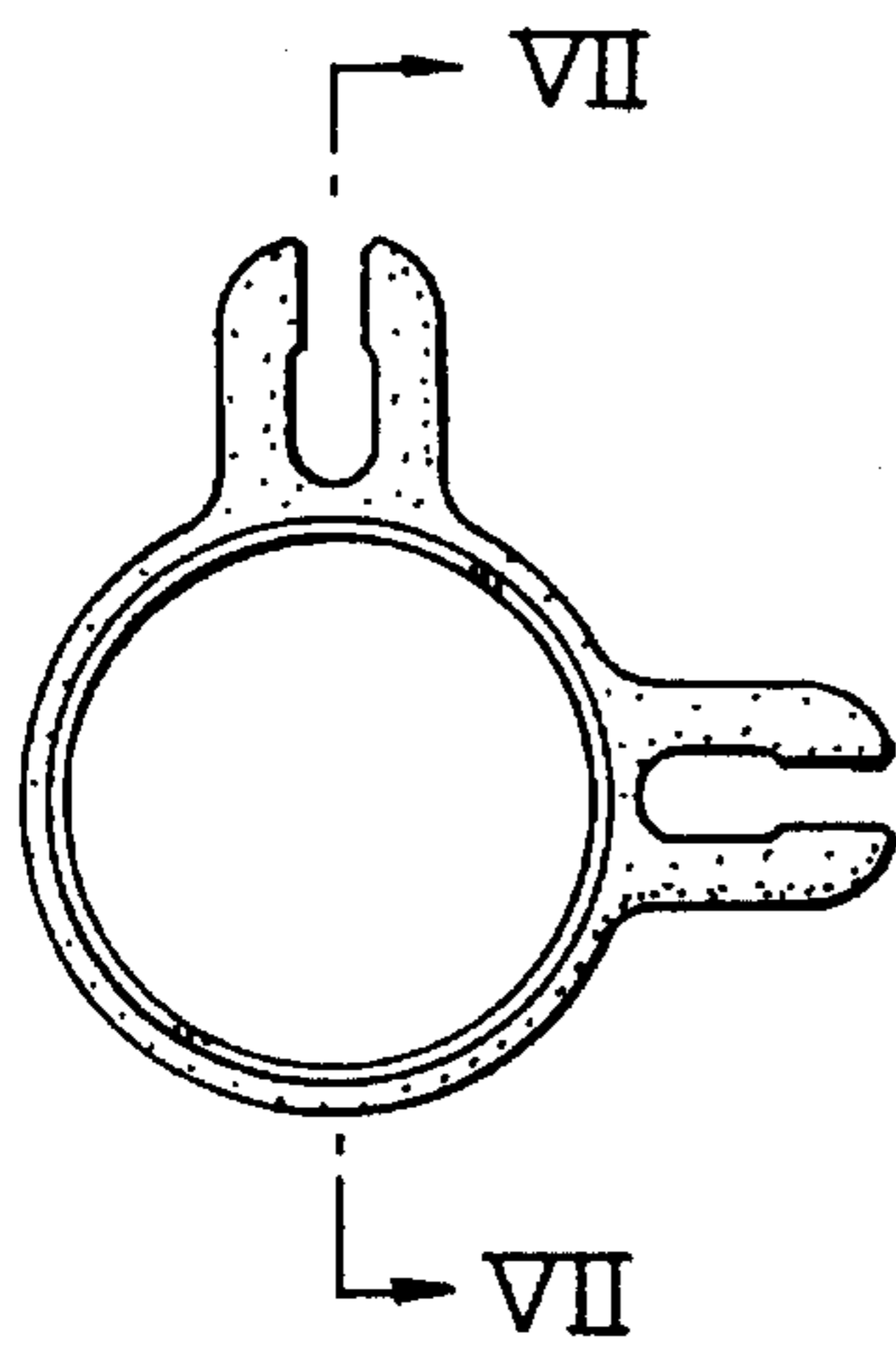

FIG. 3

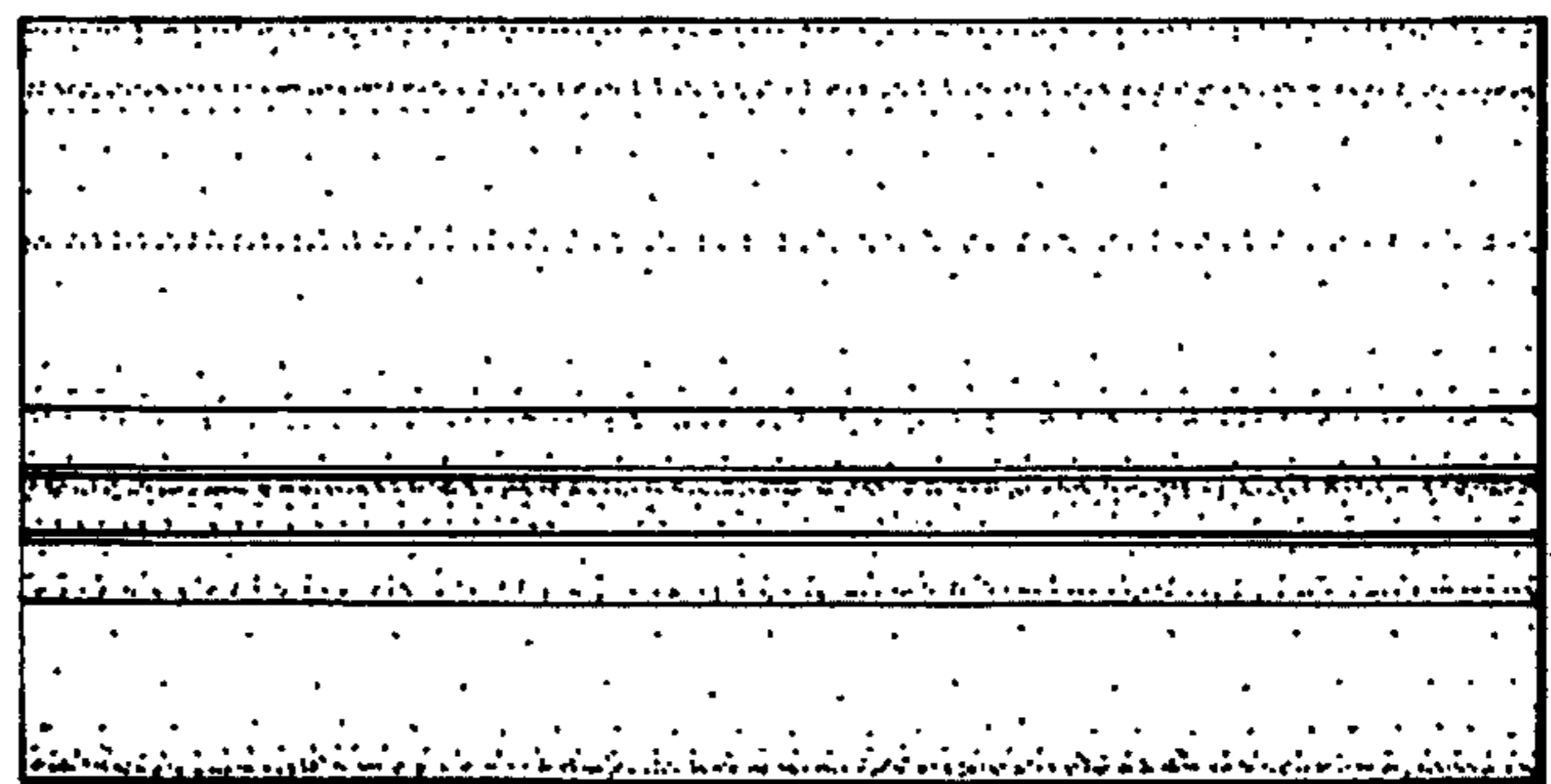

FIG. 4

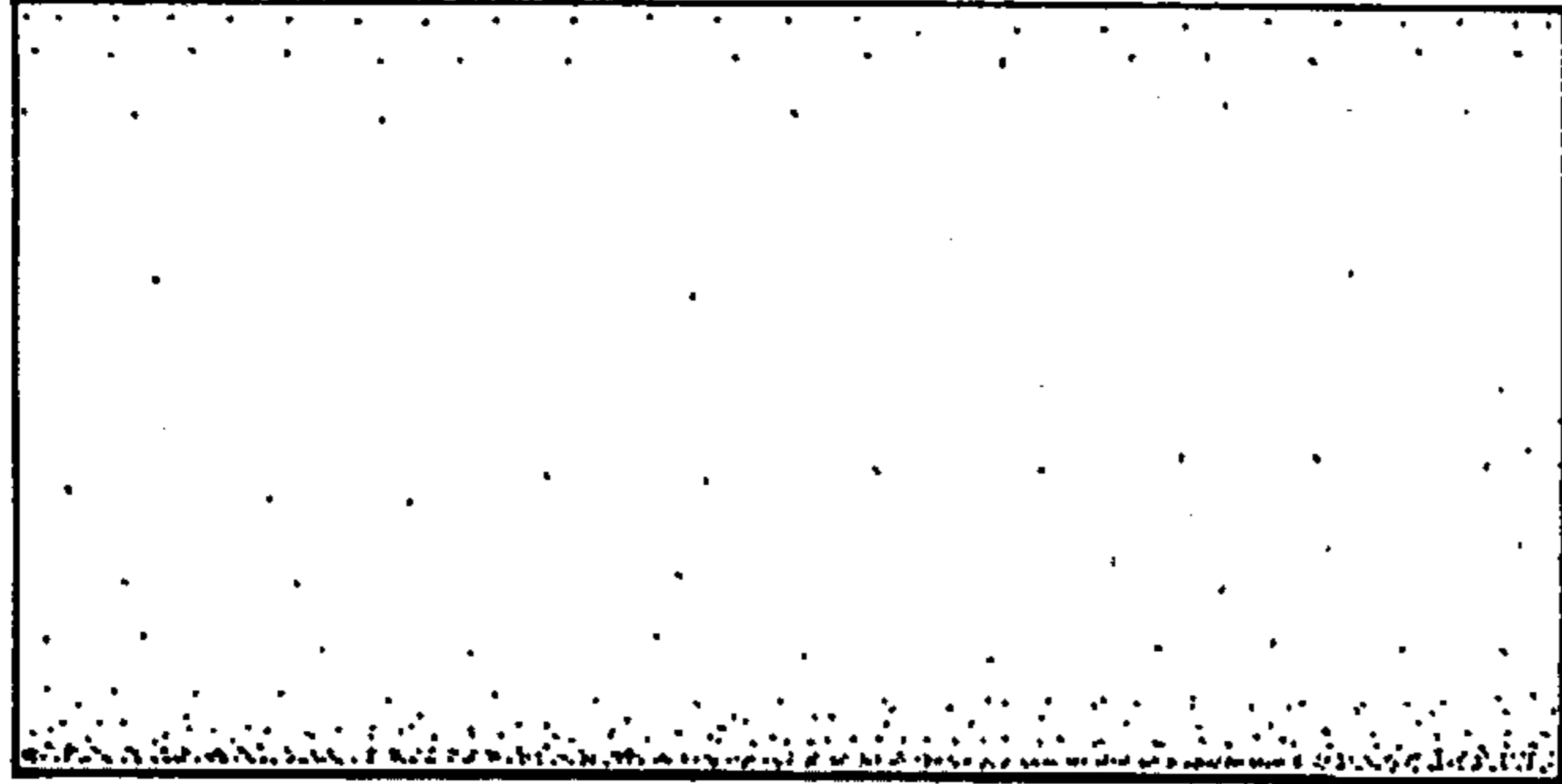

FIG. 5

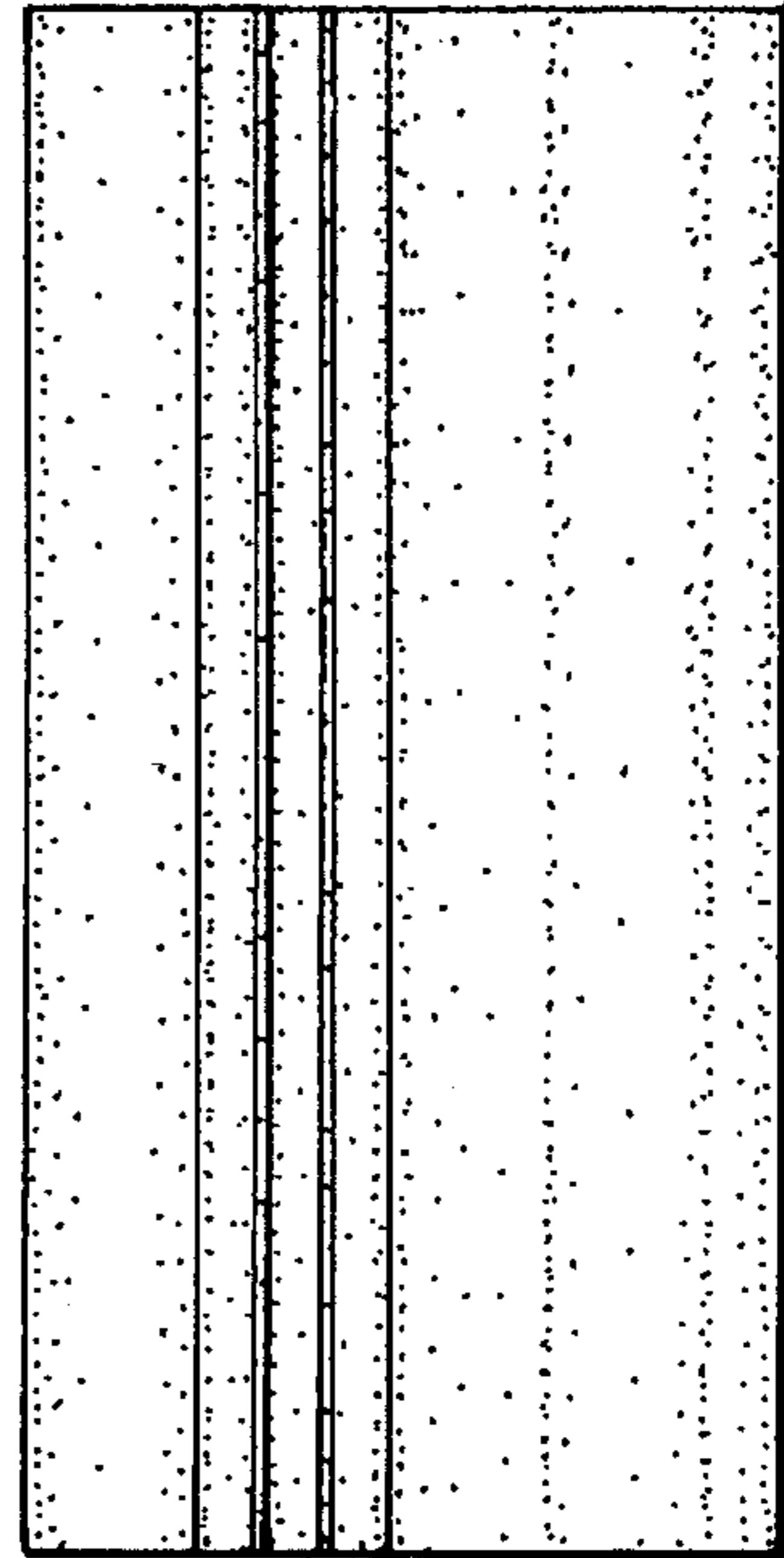

FIG. 6

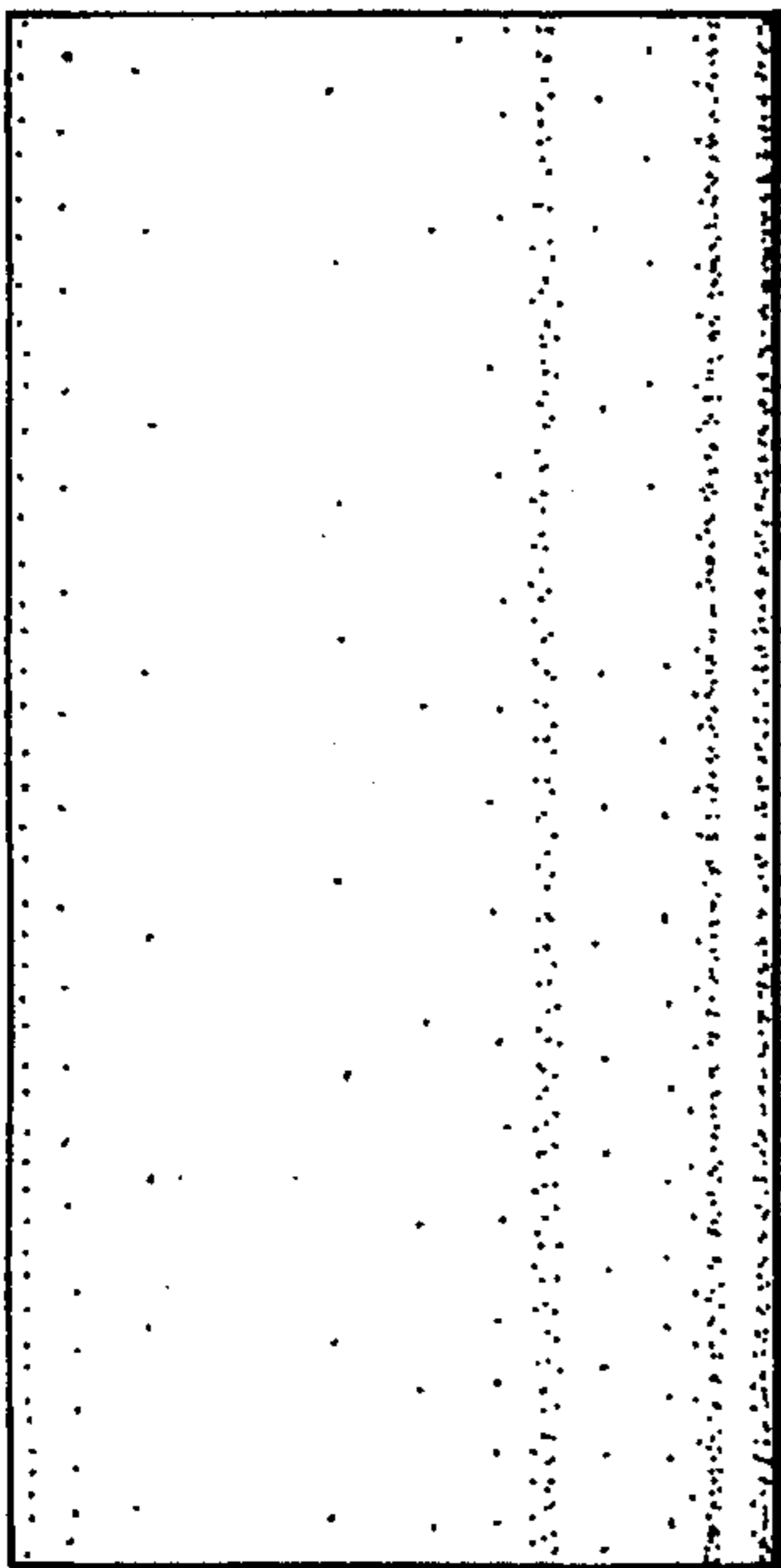

FIG. 7

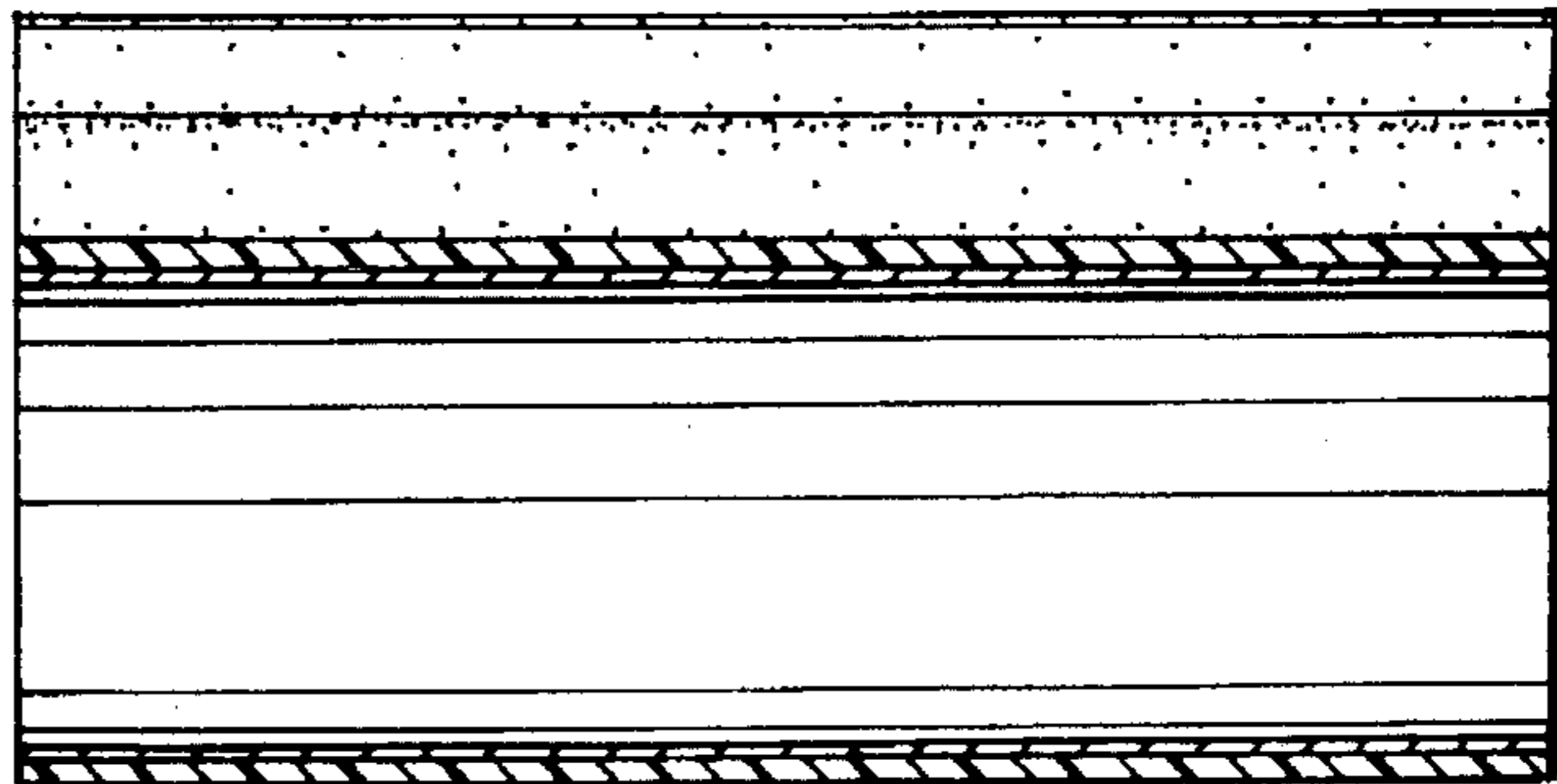

FIG. 8

