



US00D375573S

United States Patent [19]

Andres

[11] Patent Number: **Des. 375,573**

[45] Date of Patent: ****Nov. 12, 1996**

[54] **EXTRUDED RAIL MEMBER FOR
CONSTRUCTING A DECK AND THE LIKE**

4,220,316 9/1980 Naka et al. 256/59
5,200,240 4/1993 Baker 256/59

[75] Inventor: **Thomas J. Andres**, North Versailles,
Pa.

Primary Examiner—Doris Clark
Attorney, Agent, or Firm—David V. Radack; Eckert Sea-
mans Cherin & Mellott

[73] Assignee: **Thermal Industries, Inc.**, Pittsburgh,
Pa.

[57] **CLAIM**

[**] Term: **14 Years**

The ornamental design for an extruded rail member for
constructing a deck or the like, as shown and described.

[21] Appl. No.: **42,766**

DESCRIPTION

[22] Filed: **Aug. 17, 1995**

[52] U.S. Cl. **D25/164; D25/122**

[58] Field of Search D25/119, 164,
D25/122, 124; 256/59

FIG. 1 is a front perspective view of an extruded rail member
for constructing a deck and the like showing my design;
FIG. 2 is a fragmentary right side elevational view thereof;
FIG. 3 is a fragmentary left side elevational view thereof;
FIG. 4 is a fragmentary top plan view thereof;
FIG. 5 is a fragmentary bottom plan thereof;
FIG. 6 is an end elevational view thereof; and,
FIG. 7 is the opposite end elevational view thereof.

[56] **References Cited**

U.S. PATENT DOCUMENTS

D. 203,162 12/1965 Blum et al. D25/164
D. 344,141 2/1994 Wonderly D25/119

1 Claim, 4 Drawing Sheets

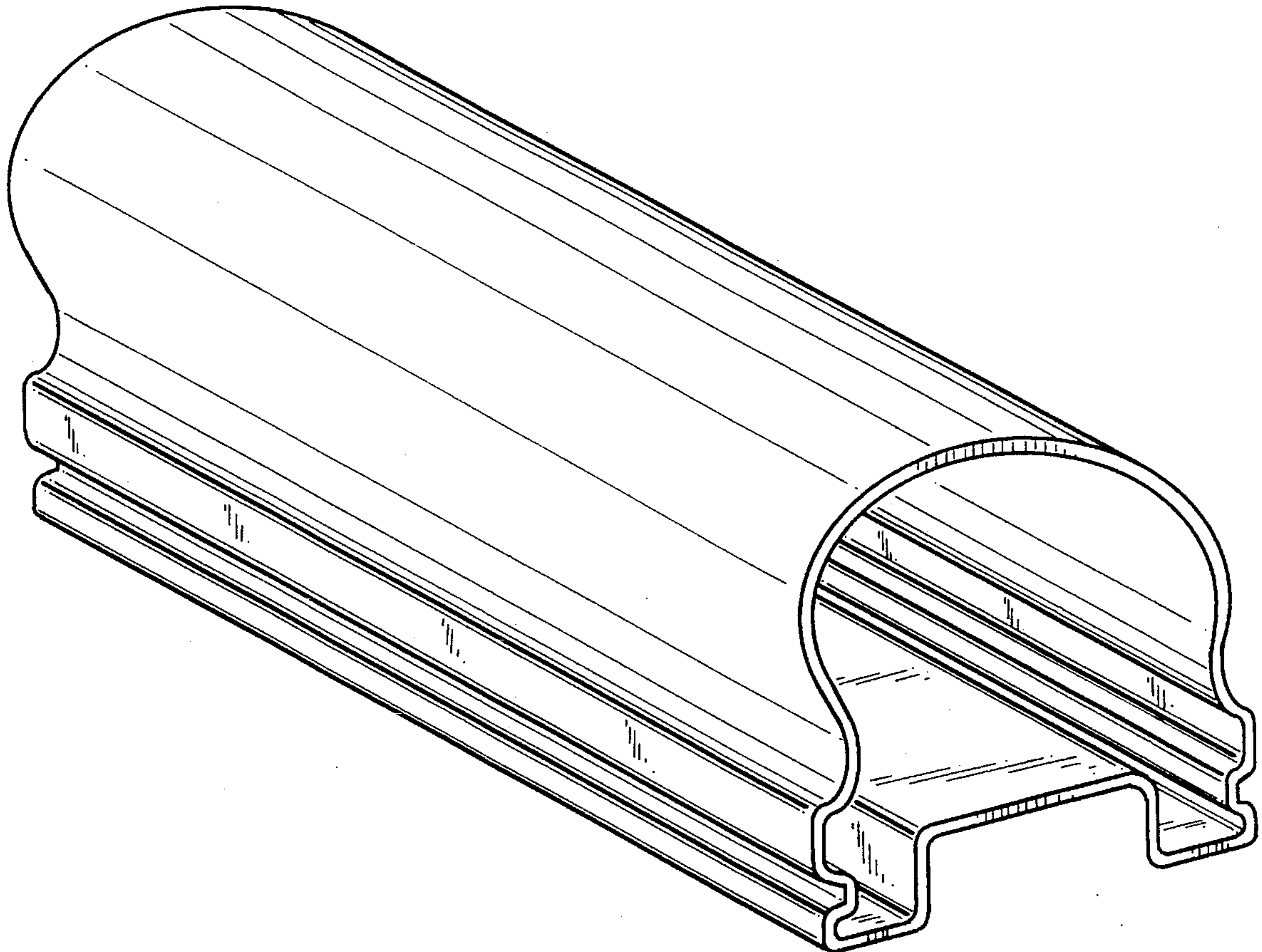

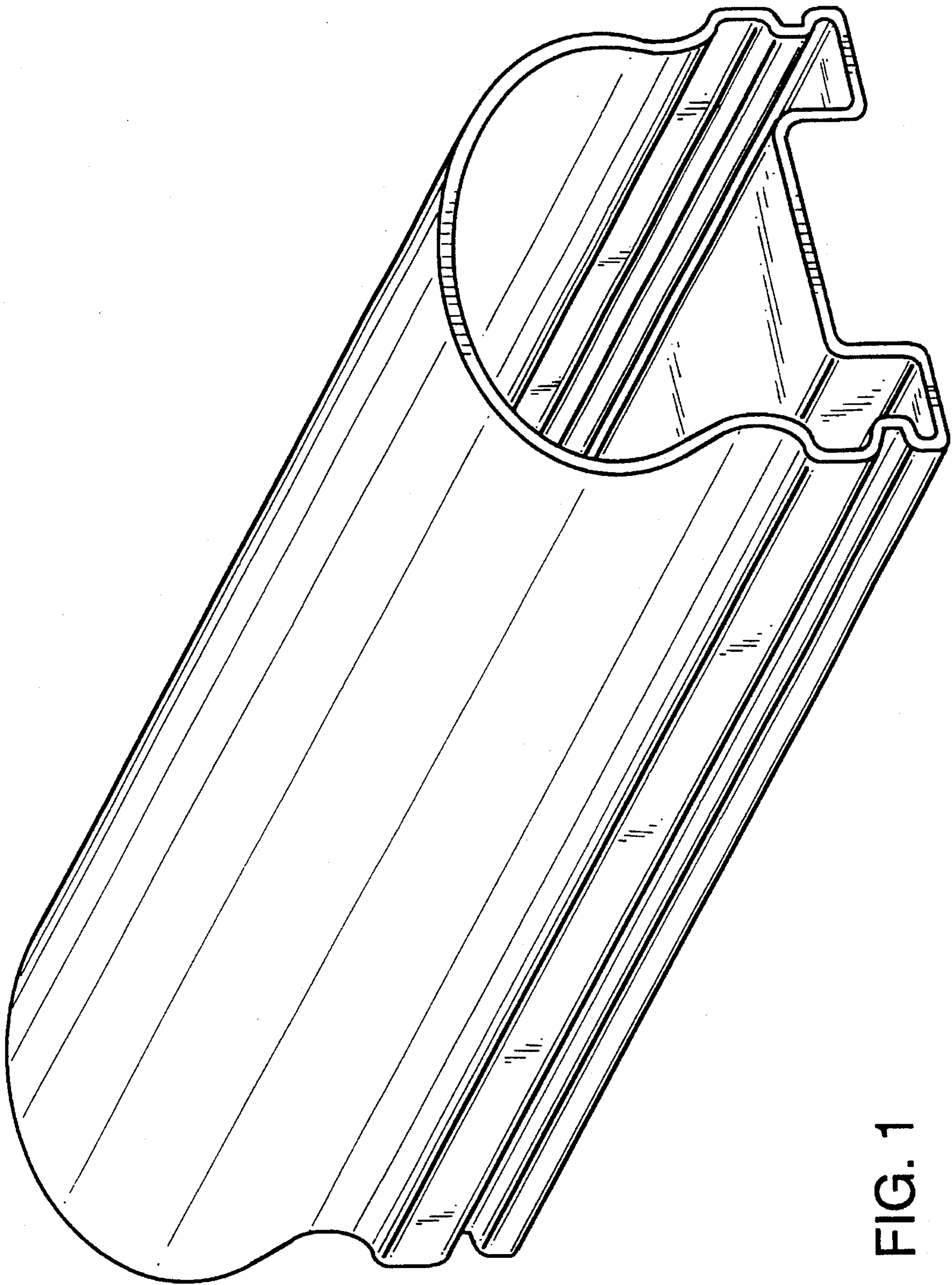

FIG. 1

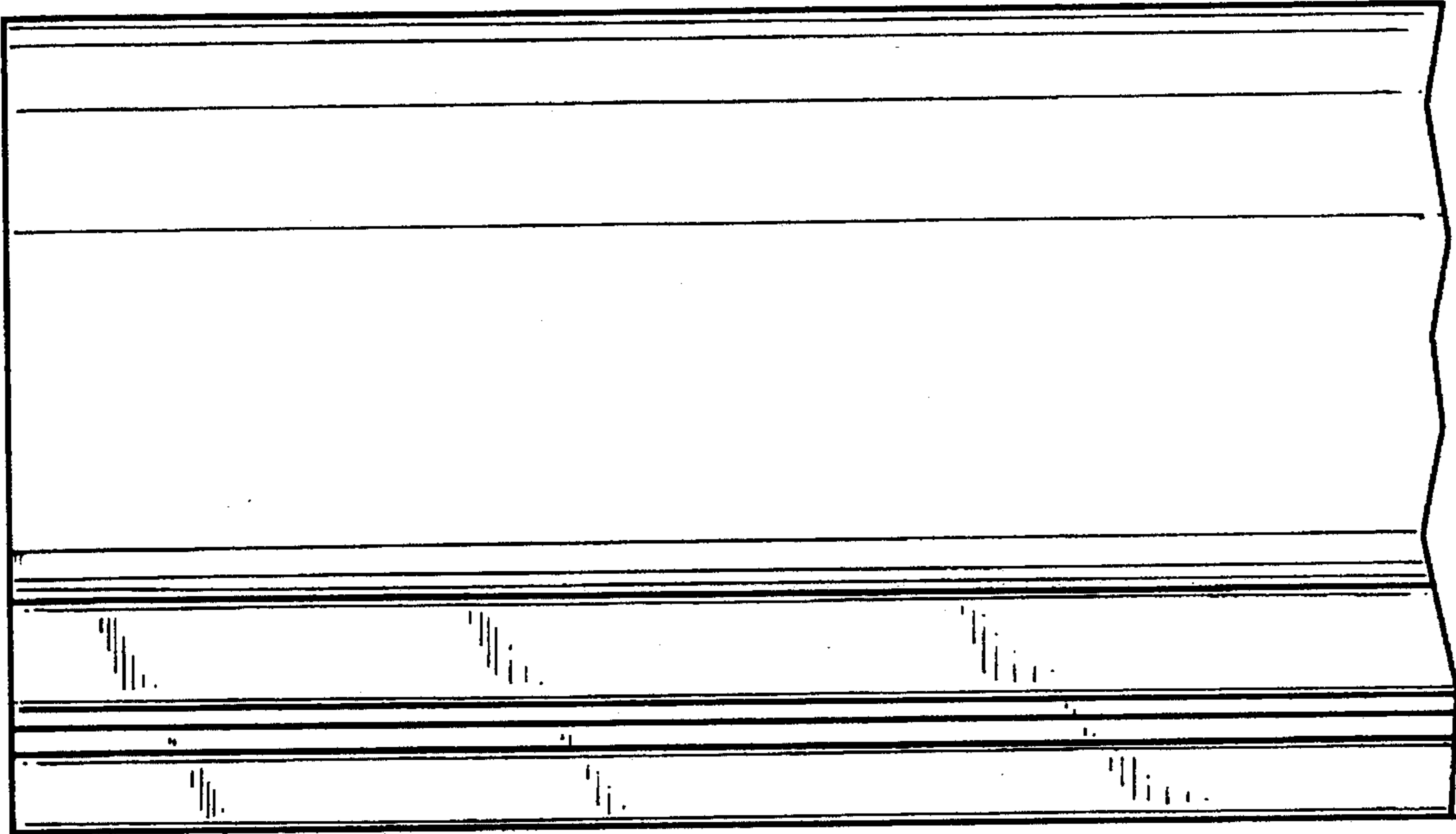

FIG. 2

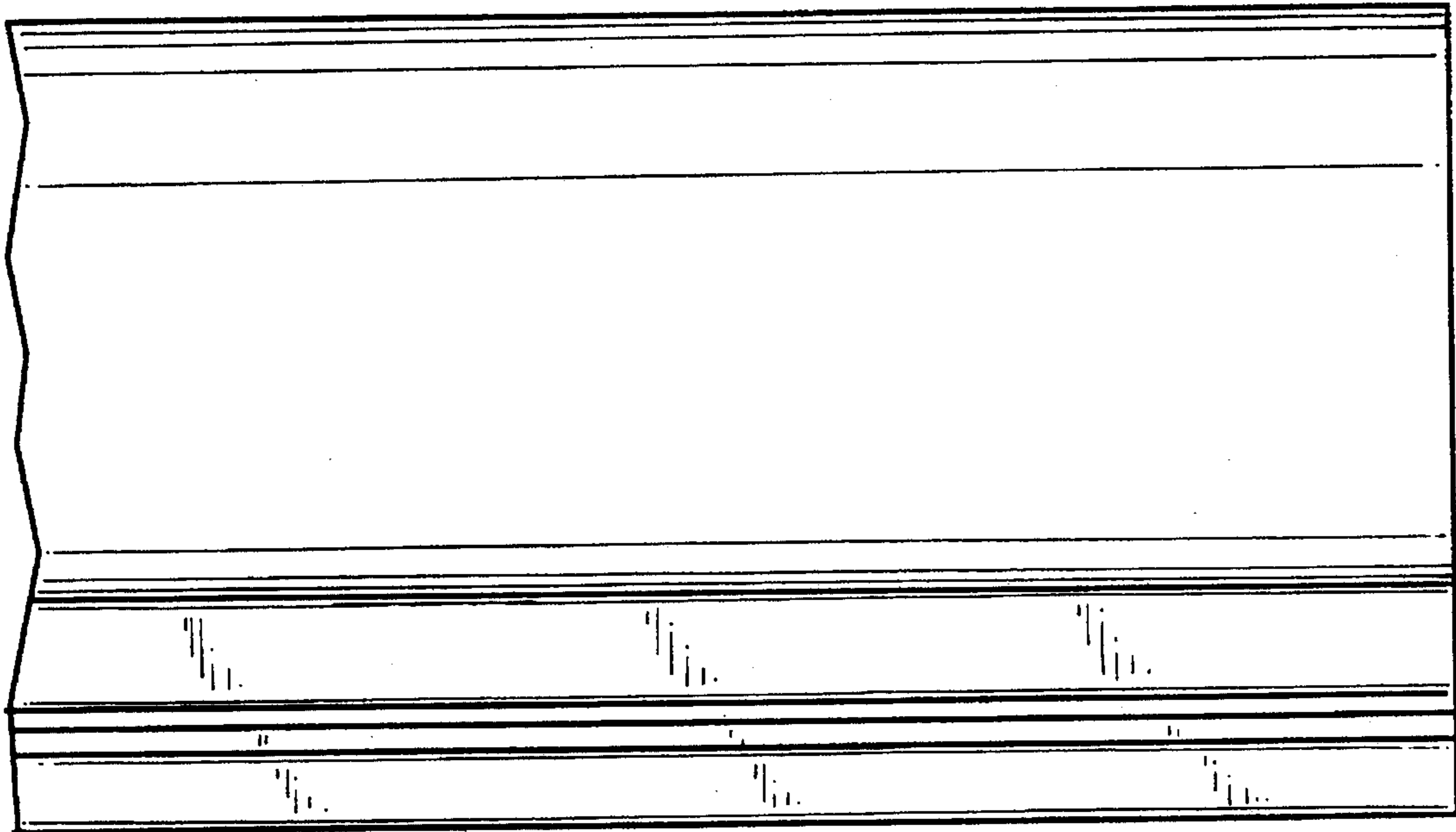

FIG. 3

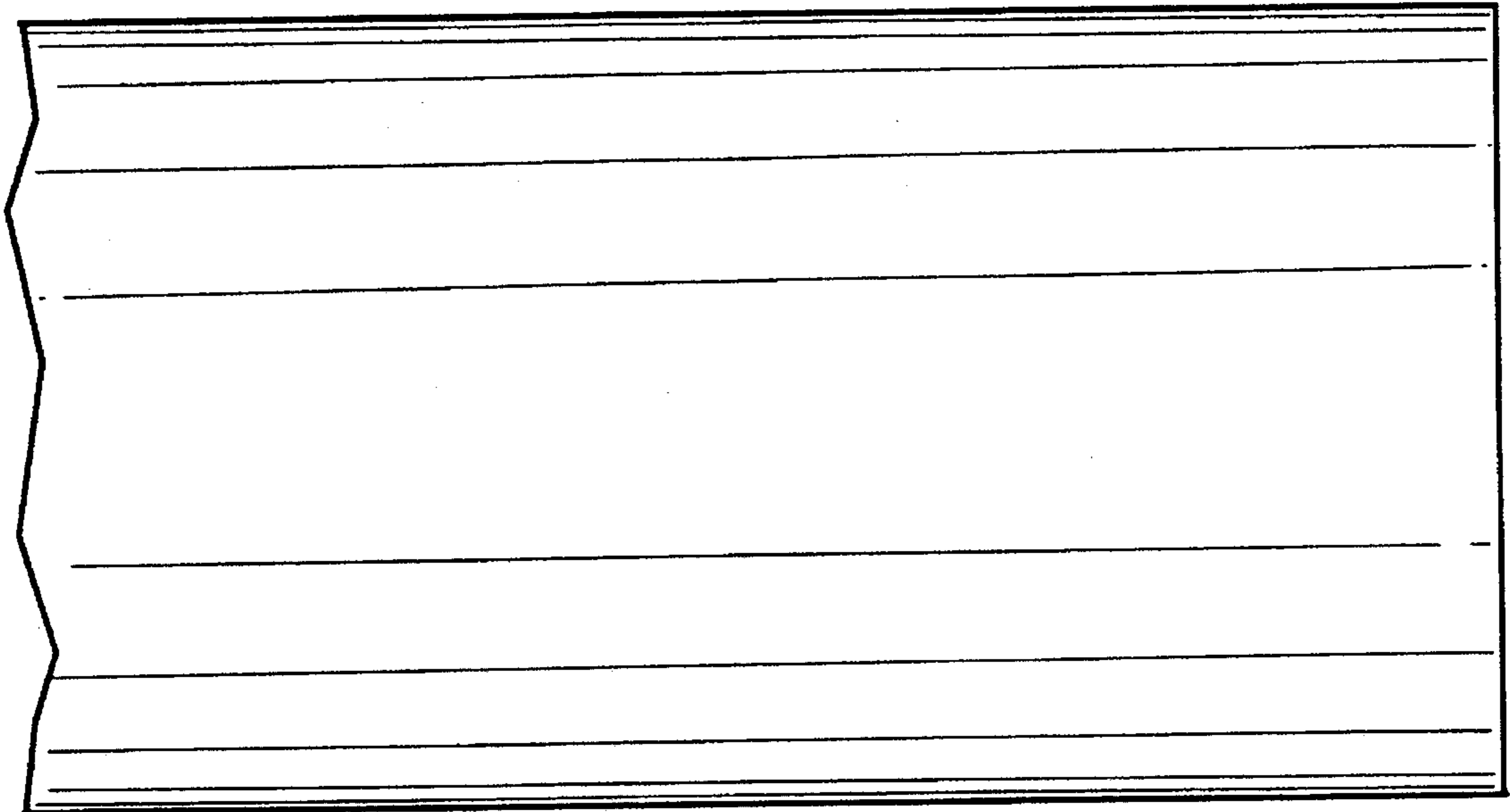

FIG. 4

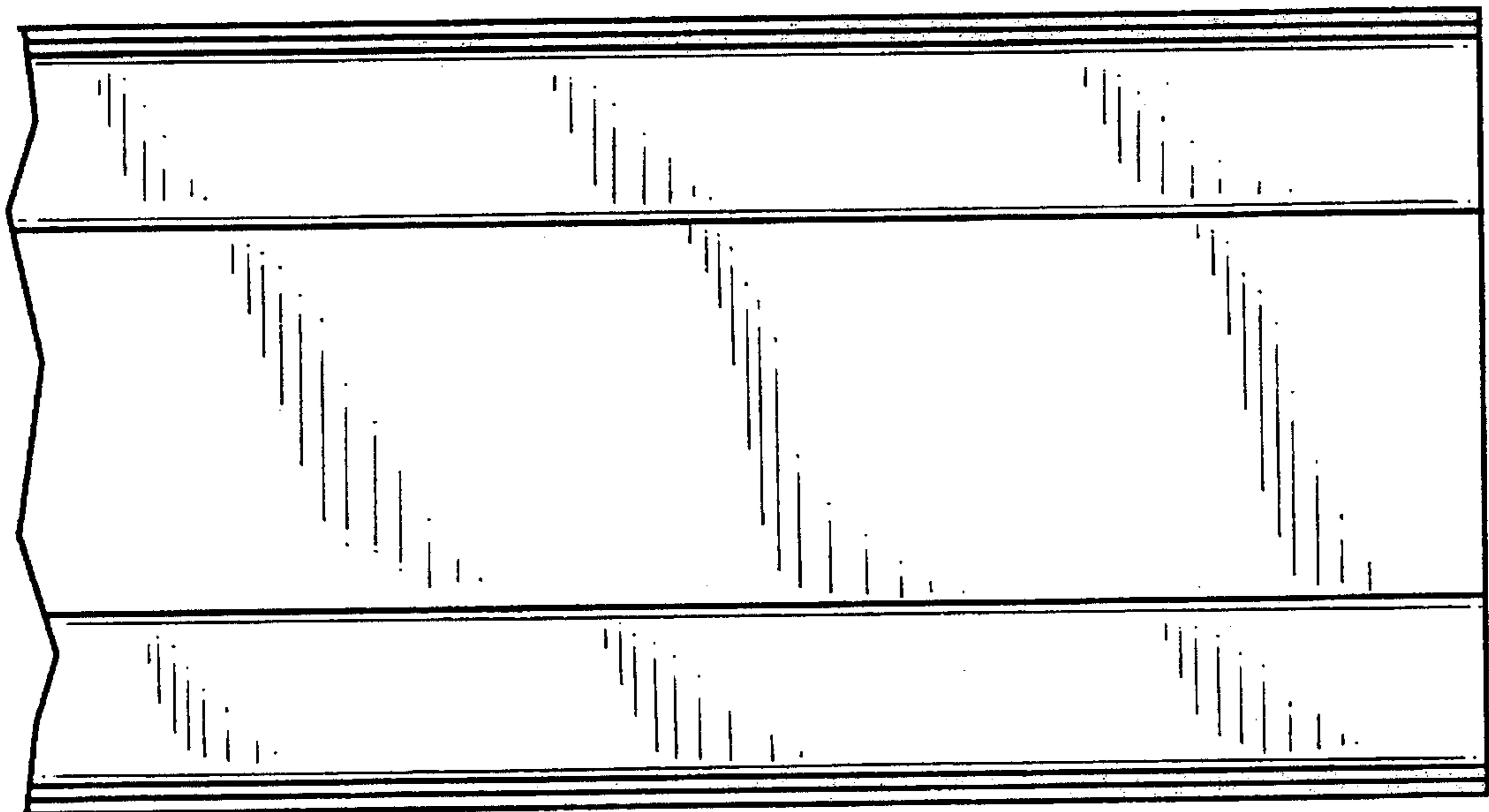

FIG. 5

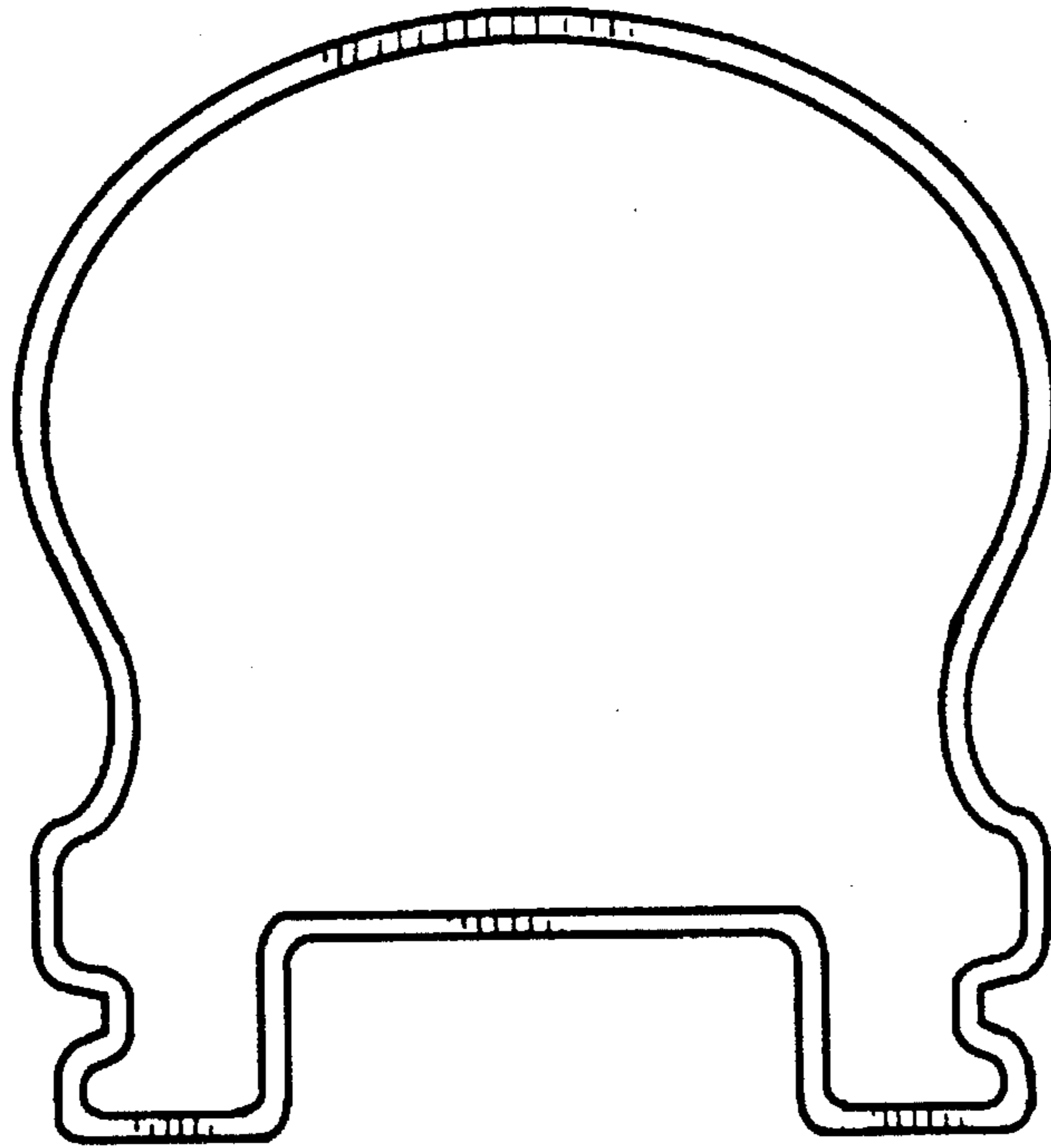

FIG. 6

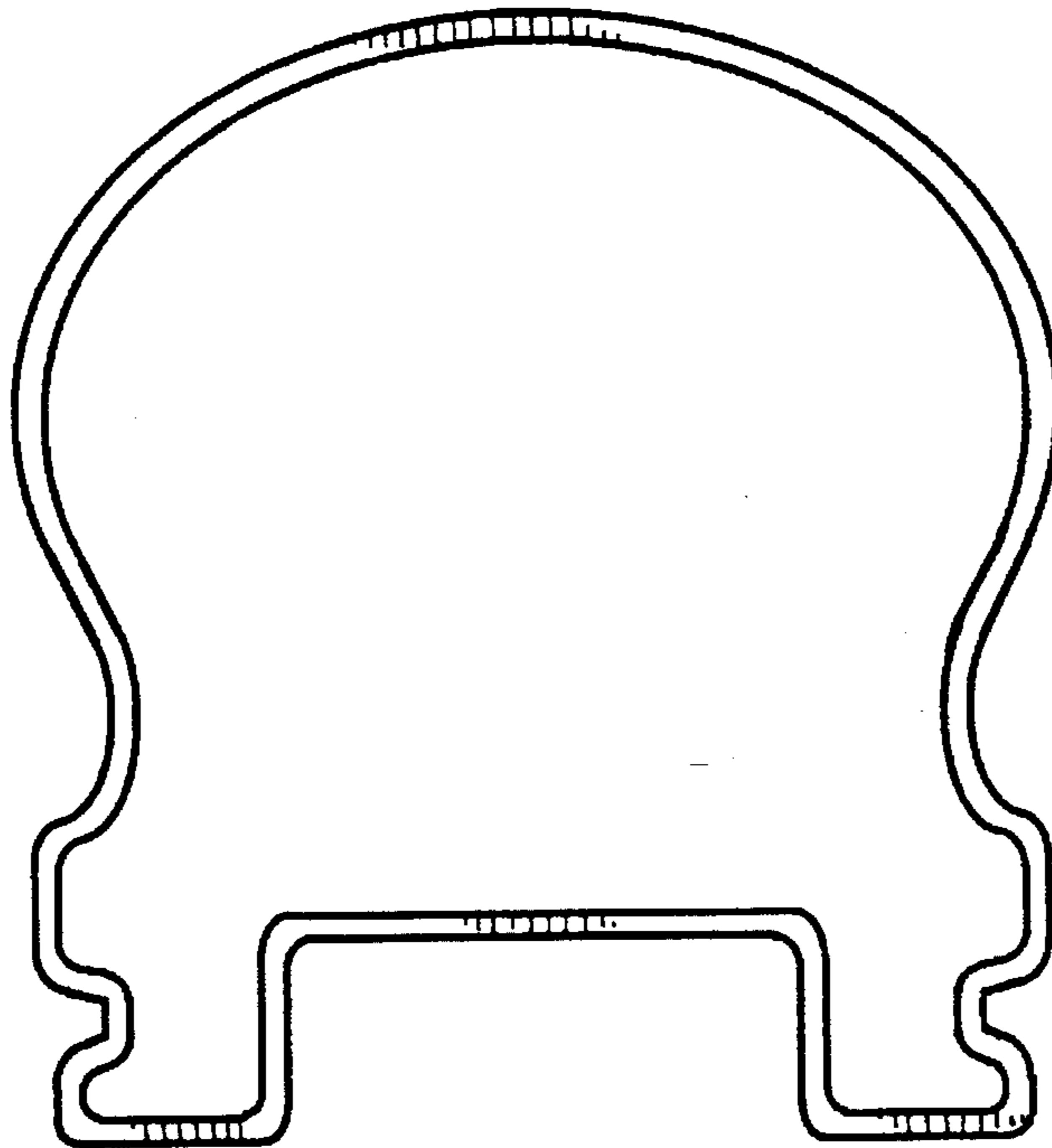

FIG. 7