



US00D375554S

**United States Patent** [19]

[11] **Patent Number: Des. 375,554**

**Lee**

[45] **Date of Patent: \*\*Nov. 12, 1996**

[54] **FEMALE HYGIENE APPARATUS**

[76] **Inventor: Robbie S. Lee, 17,900 Bull Canyon Rd., Granada Hills, Calif. 91344**

[\*\*] **Term: 14 Years**

[21] **Appl. No.: 28,067**

[22] **Filed: Sep. 6, 1994**

[52] **U.S. Cl. .... D24/115; D24/112; D24/118**

[58] **Field of Search ..... D24/118, 112, D24/115, 121; D9/522, 523, 526, 527, 528, 543, 300, 337; 383/901; 604/39, 150, 181, 185, 262**

[56] **References Cited**

**U.S. PATENT DOCUMENTS**

D. 103,287	2/1937	Reynolds	.....	D9/543 X
D. 329,814	9/1992	Libit	.....	D9/526
D. 347,790	6/1994	Lathrop et al.	.....	D9/523
D. 362,501	9/1995	Louviere	.....	D24/118 X
991,844	5/1911	Gillette	.....	383/901 X
5,102,387	4/1992	Jorde	.....	604/262 X

*Primary Examiner*—James M. Gandy  
*Assistant Examiner*—Linda Brooks  
*Attorney, Agent, or Firm*—Gene W. Arant

[57] **CLAIM**

The ornamental design for a female hygiene apparatus, as shown and described.

**DESCRIPTION**

FIG. 1 is a perspective view of the front, left and top of my

new female hygiene apparatus;

FIG. 2 is a front end elevational view of the apparatus;

FIG. 3 is a rear elevational view;

FIG. 4 is a top plan view;

FIG. 5 is a bottom plan view;

FIG. 6 is a left side elevational view;

FIG. 7 is a right side elevational view; and,

FIG. 8 is a perspective view of another embodiment of my new female hygiene apparatus with the cap in open position, it being understood that the only differences reside in the length and shape of the edge of the neck element and the circular shape in the center;

FIG. 9 is an elevational view of FIG. 8 on a reduced scale when hung in an upside down position.

The strap is shown broken away in FIG. 1,2,3,4,5,6,7, and 8 for convenience of illustration.

In FIG. 9, the broken line showing of a wall and hanger is for purposes of illustration only and forms no part of the claimed design.

In FIG. 9, the broken line showing of a wall and hanger is for purposes of illustration only and forms no part of the claimed design.

**1 Claim, 4 Drawing Sheets**

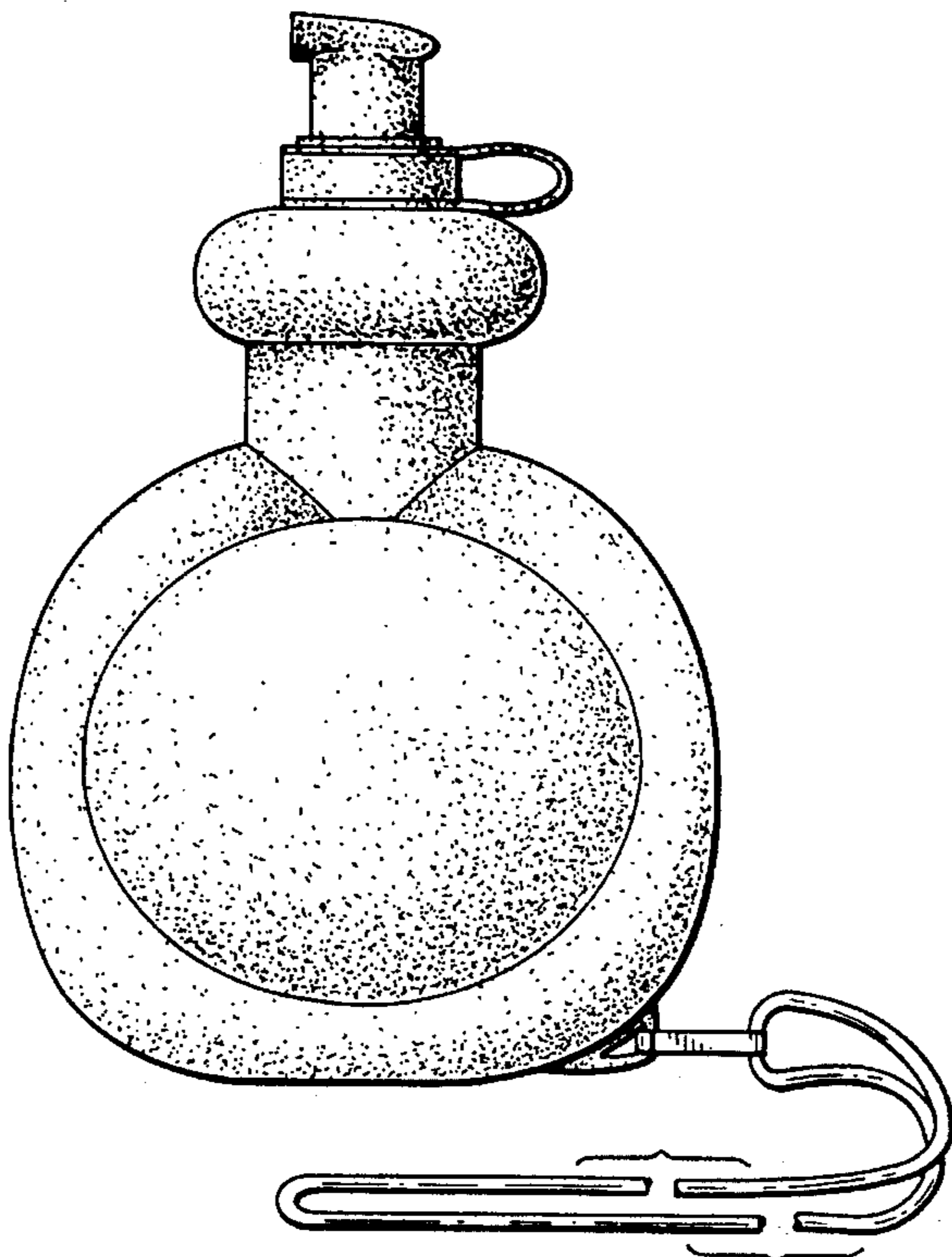

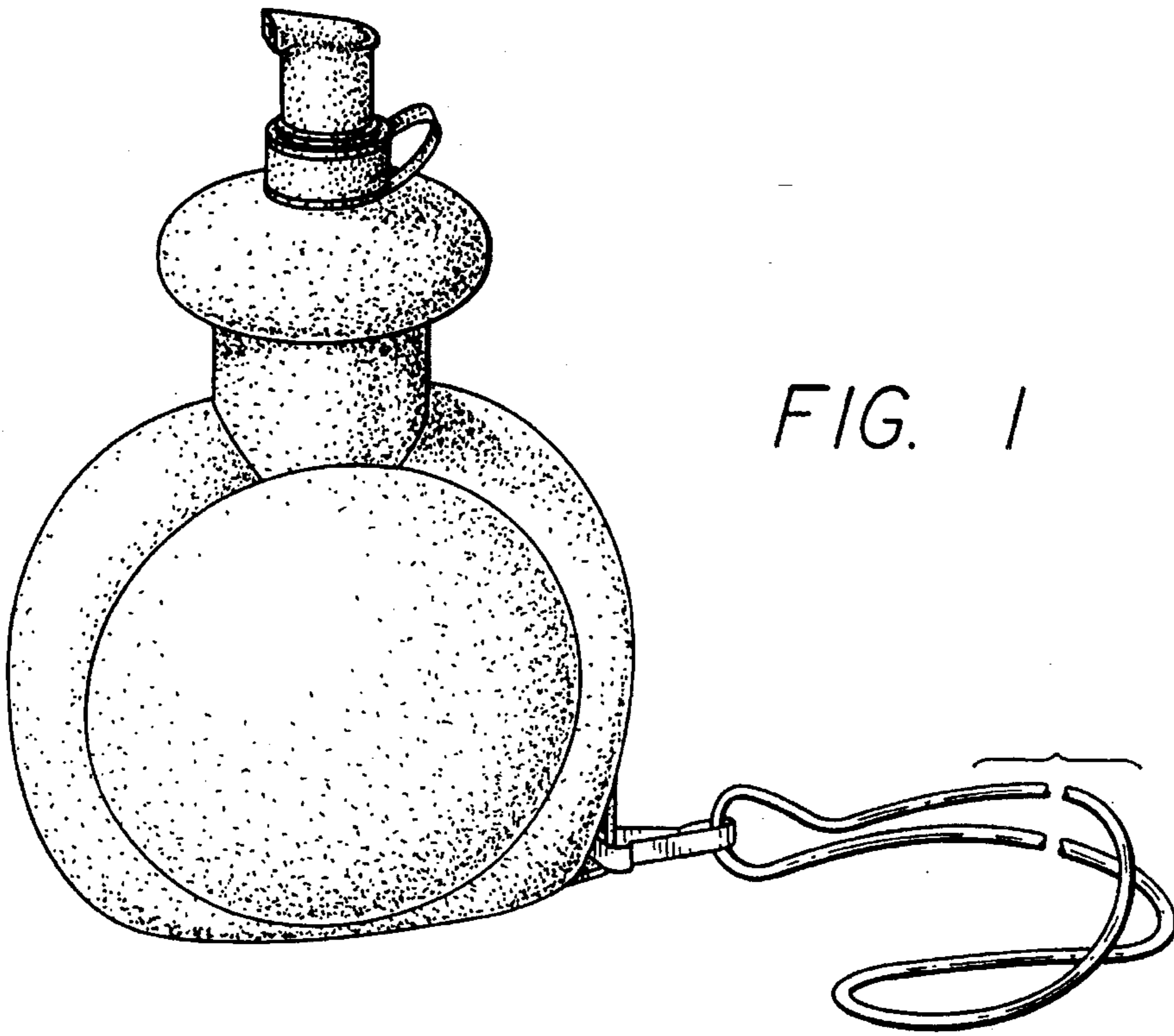

FIG. 1

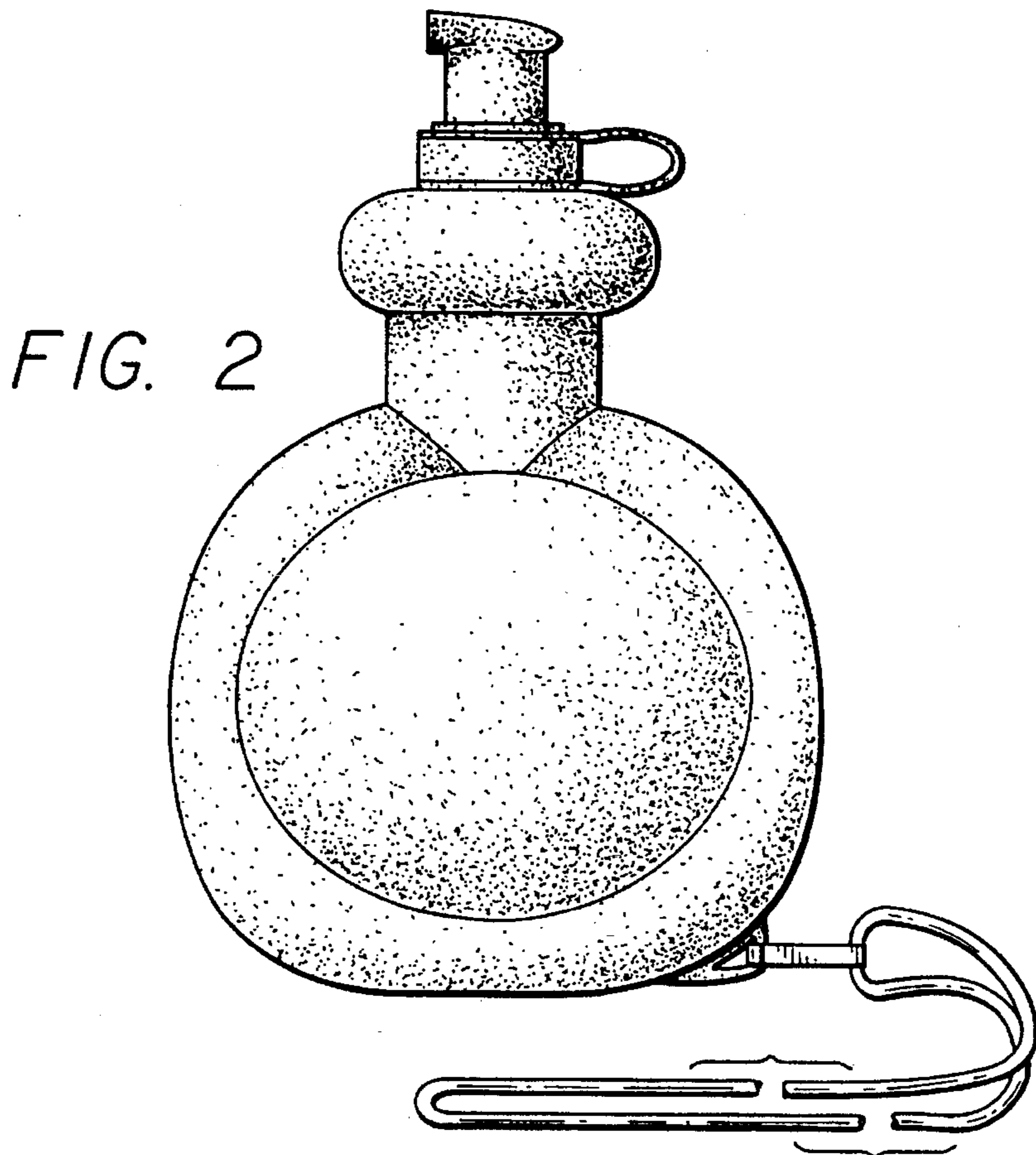

FIG. 2



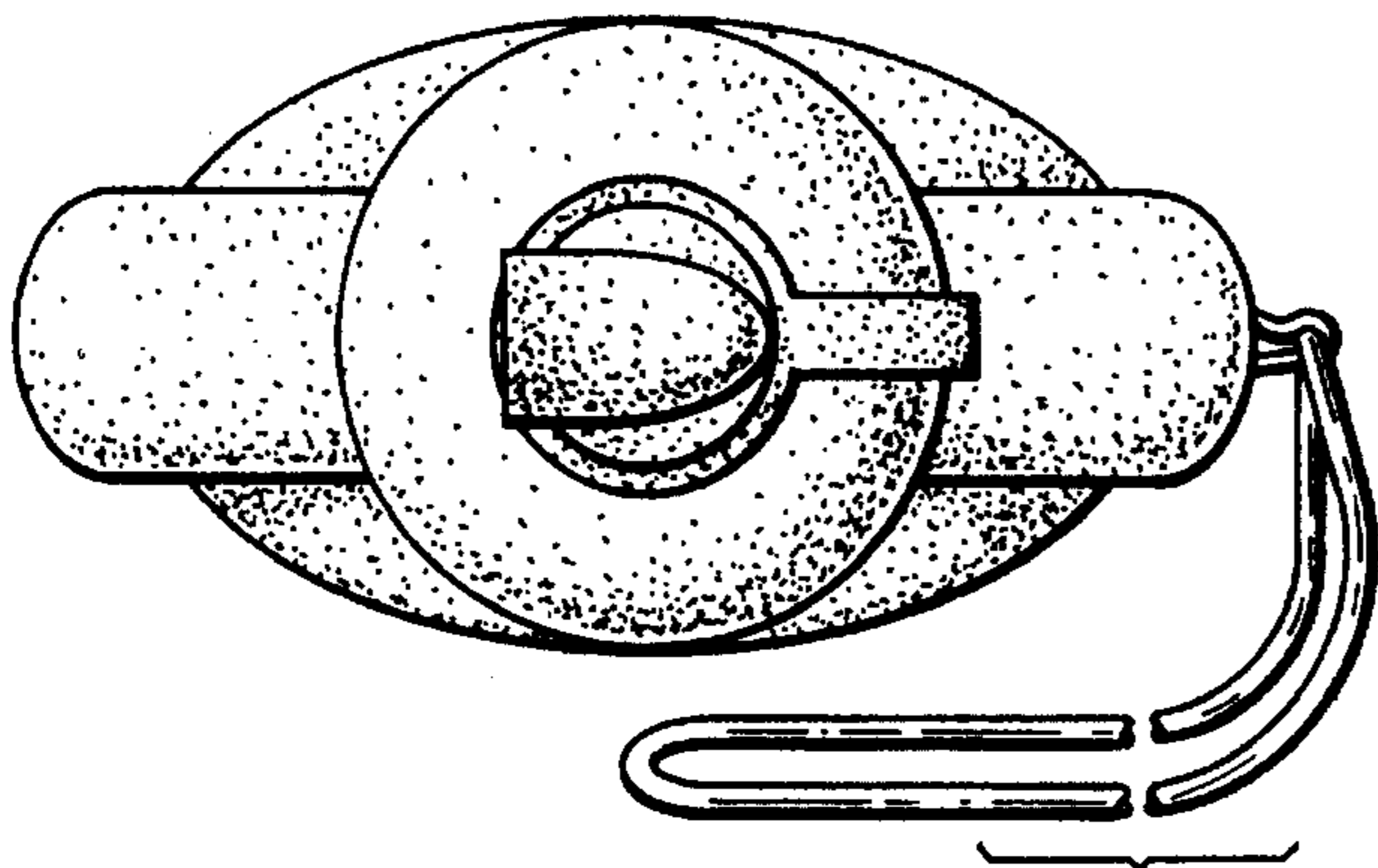

FIG. 4

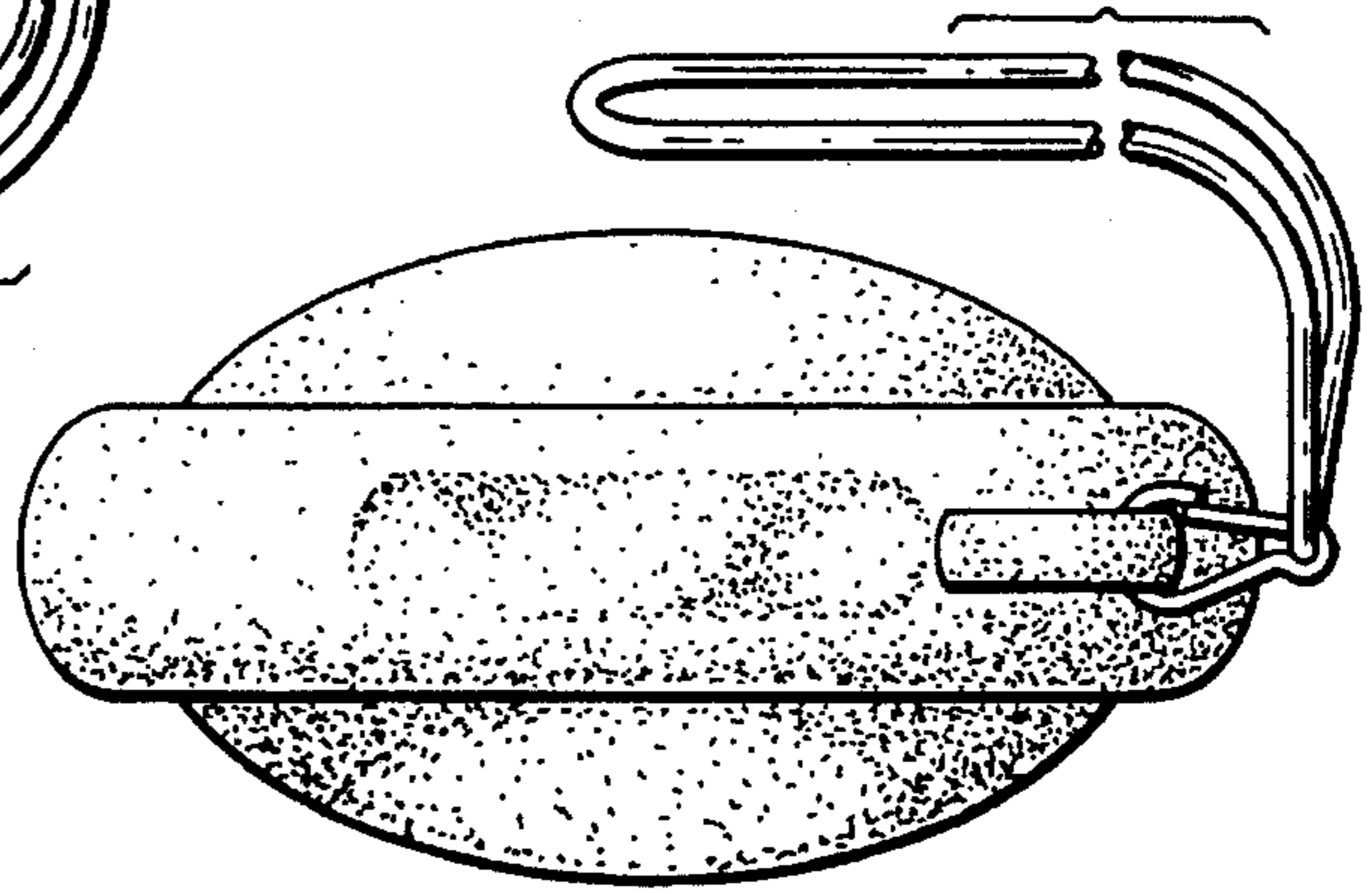

FIG. 5

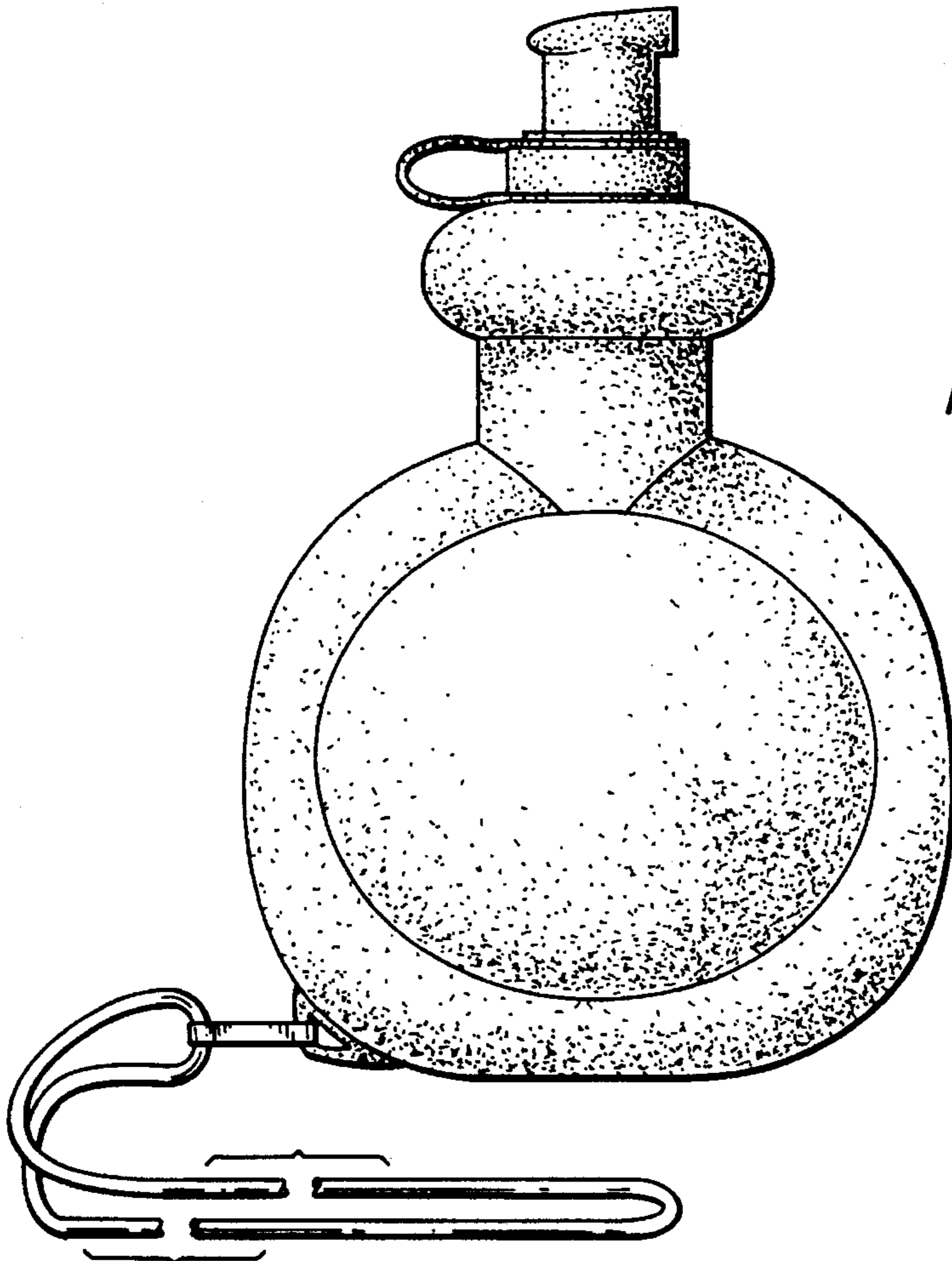

FIG. 3

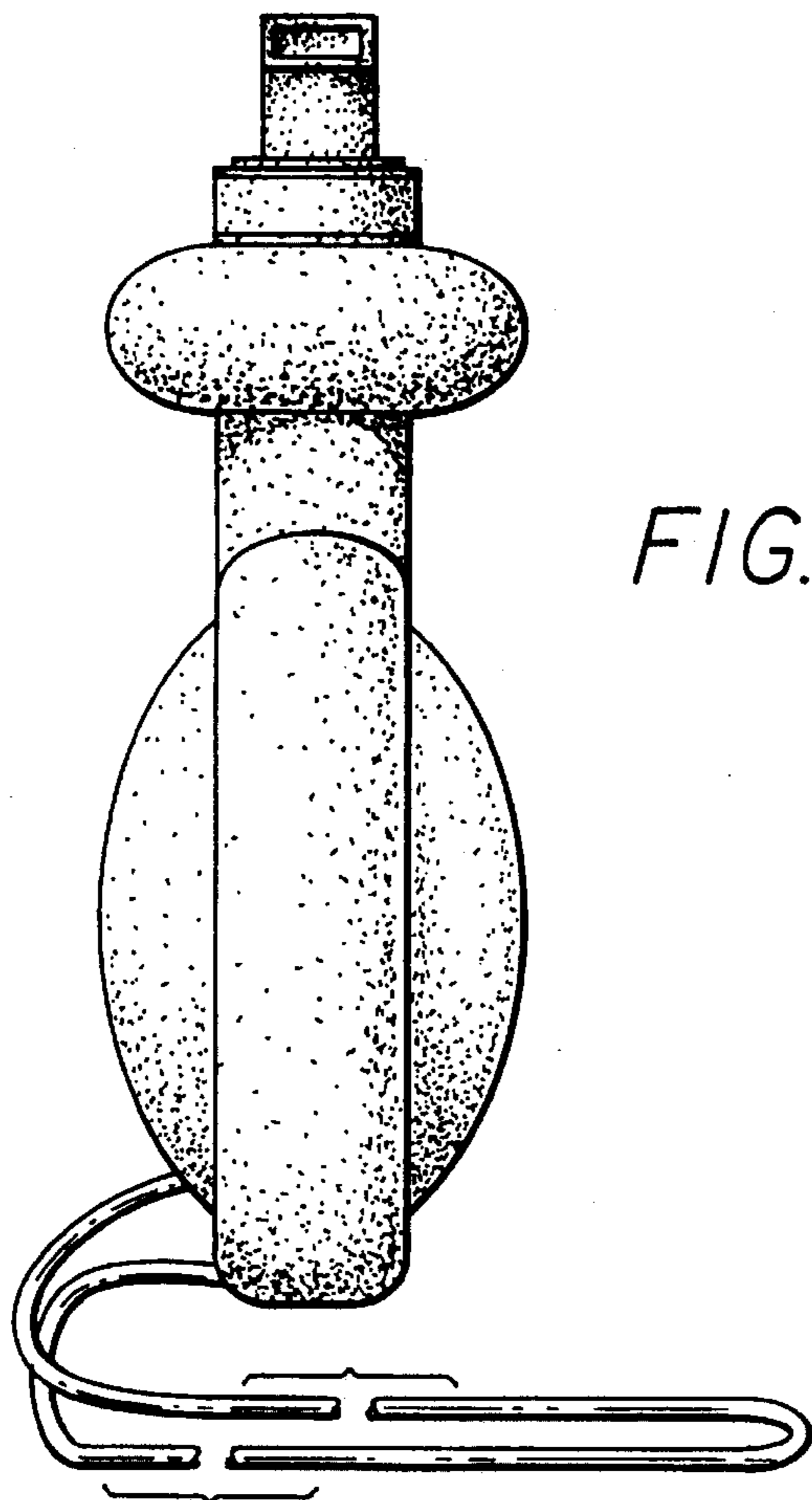

FIG. 6

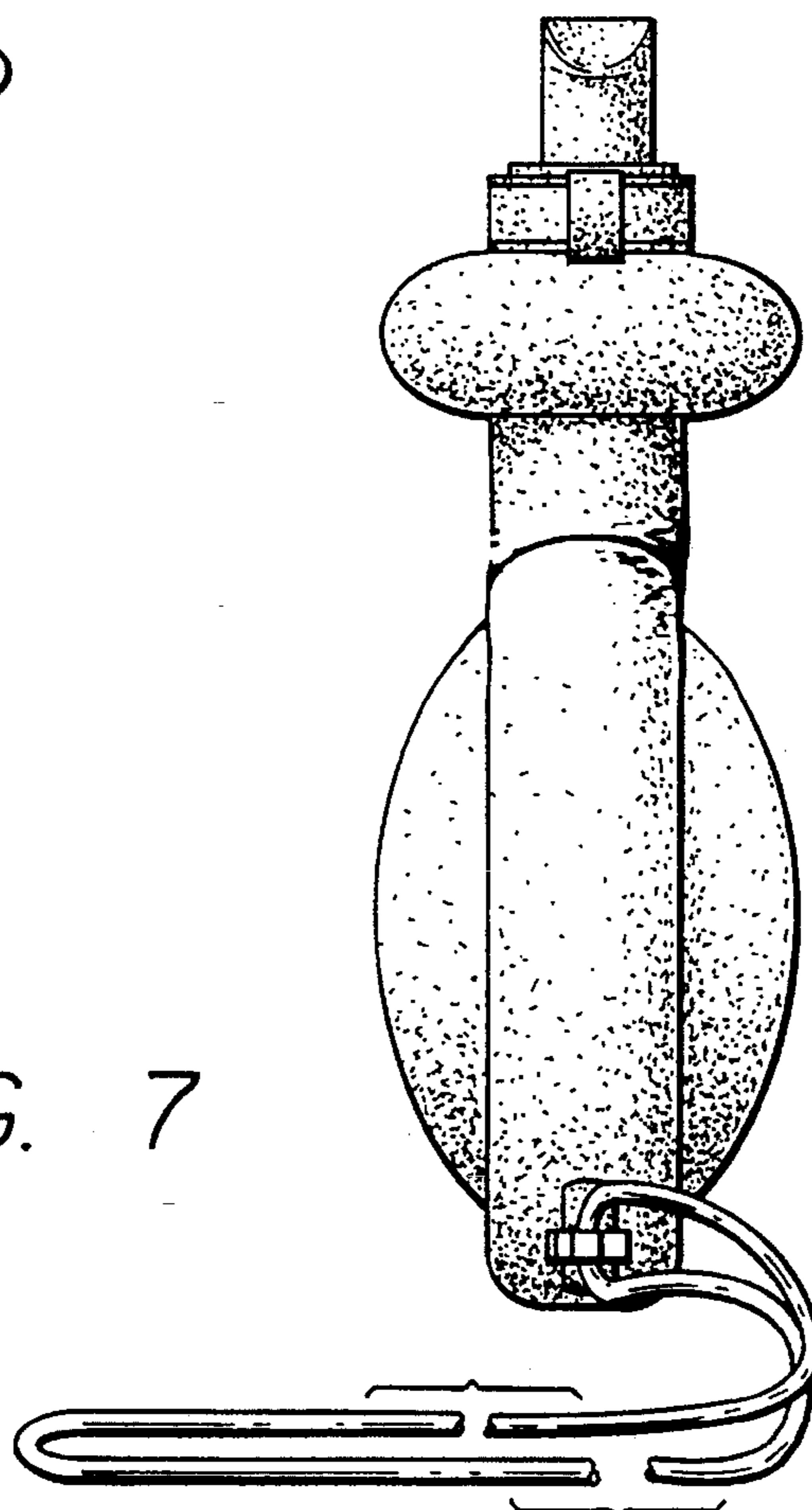

FIG. 7

FIG. 8

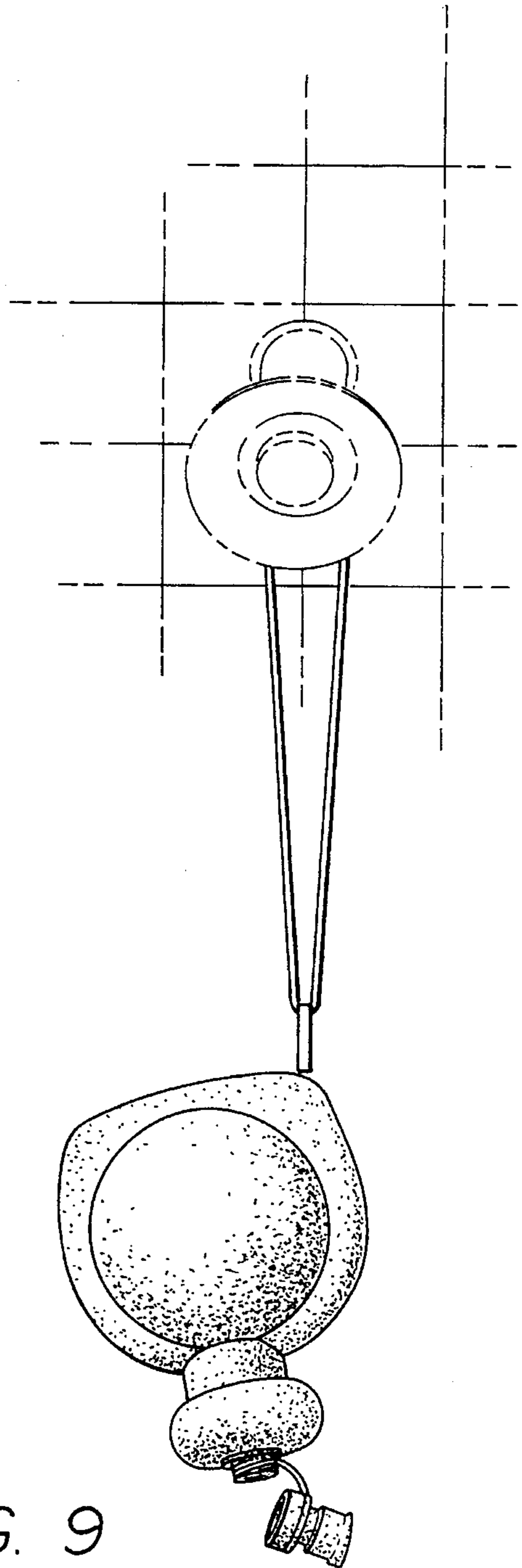
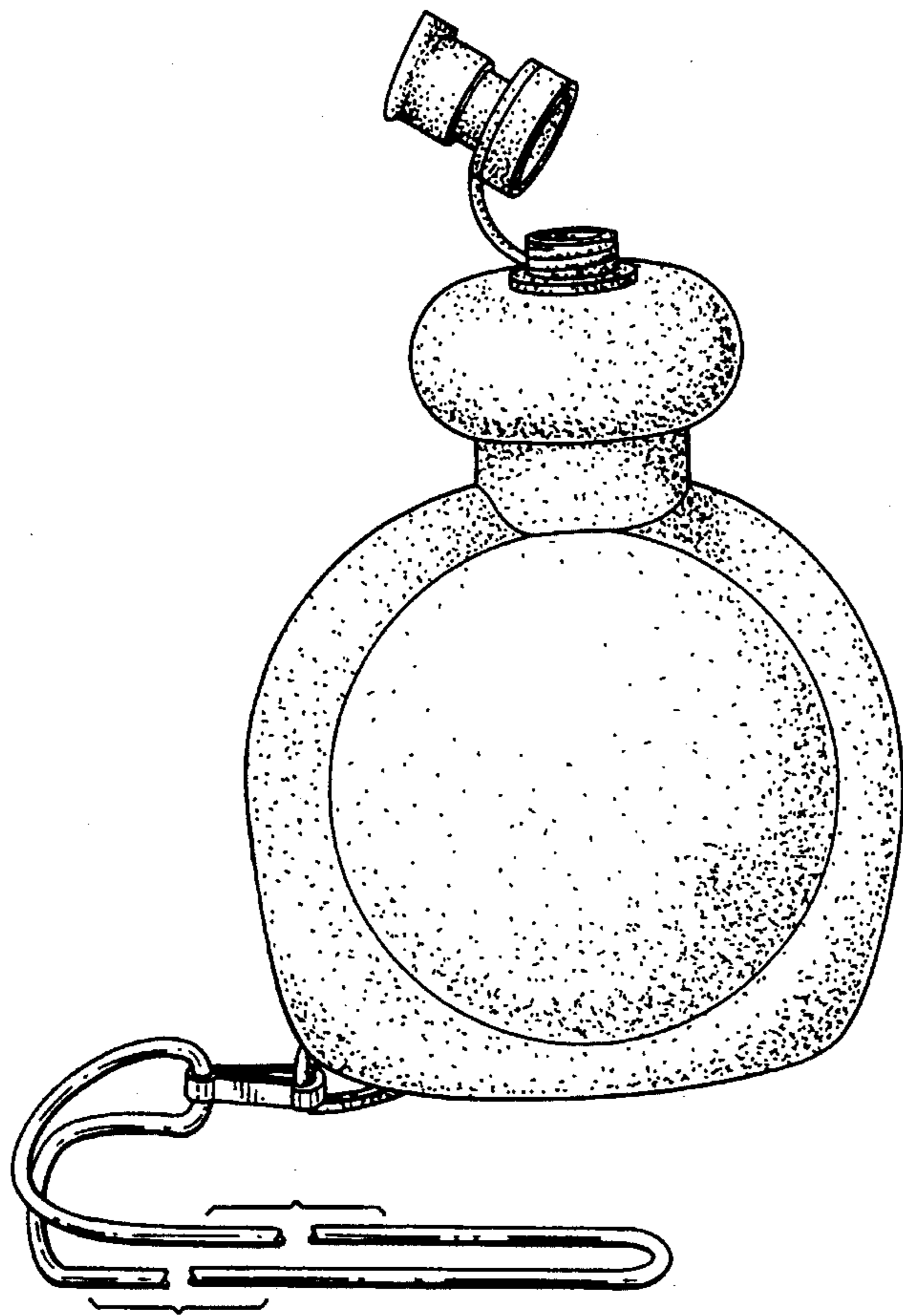

FIG. 9