



US00D375487S

United States Patent [19]

[11] Patent Number: **Des. 375,487**

Tashiro

[45] Date of Patent: ****Nov. 12, 1996**

[54] **IMAGE READING DEVICE**

D. 366,467 1/1996 Masujima et al. D14/107

[75] Inventor: **Naoki Tashiro**, Kawasaki, Japan

Primary Examiner—Freda Nunn

[73] Assignee: **Canon Kabushiki Kaisha**, Tokyo, Japan

Attorney, Agent, or Firm—Fitzpatrick, Cella, Harper & Scinto

[**] Term: **14 Years**

[57] CLAIM

[21] Appl. No.: **44,400**

The ornamental design for an image reading device, as shown and described.

[22] Filed: **Sep. 21, 1995**

DESCRIPTION

[30] Foreign Application Priority Data

Mar. 23, 1995 [JP] Japan 7-7778

[52] U.S. Cl. **D14/107**

[58] Field of Search D14/100, 105, D14/107, 118; D16/208, 214, 223, 232; D18/36, 37, 39; 250/563, 566; 235/454, 462, 470, 380, 382, 382.5, 476, 482, 483, 441; 358/408, 472, 474, 497

FIG. 1 is a front elevational view of an image reading device showing my new design;

FIG. 2 is a rear elevational view thereof;

FIG. 3 is a top plan view thereof;

FIG. 4 is a bottom plan view thereof;

FIG. 5 is a left side elevational view thereof;

FIG. 6 is a right side elevational view thereof; and,

FIG. 7 is a perspective view thereof.

[56] References Cited

U.S. PATENT DOCUMENTS

D. 357,675 4/1995 Guber et al. D14/107

1 Claim, 2 Drawing Sheets

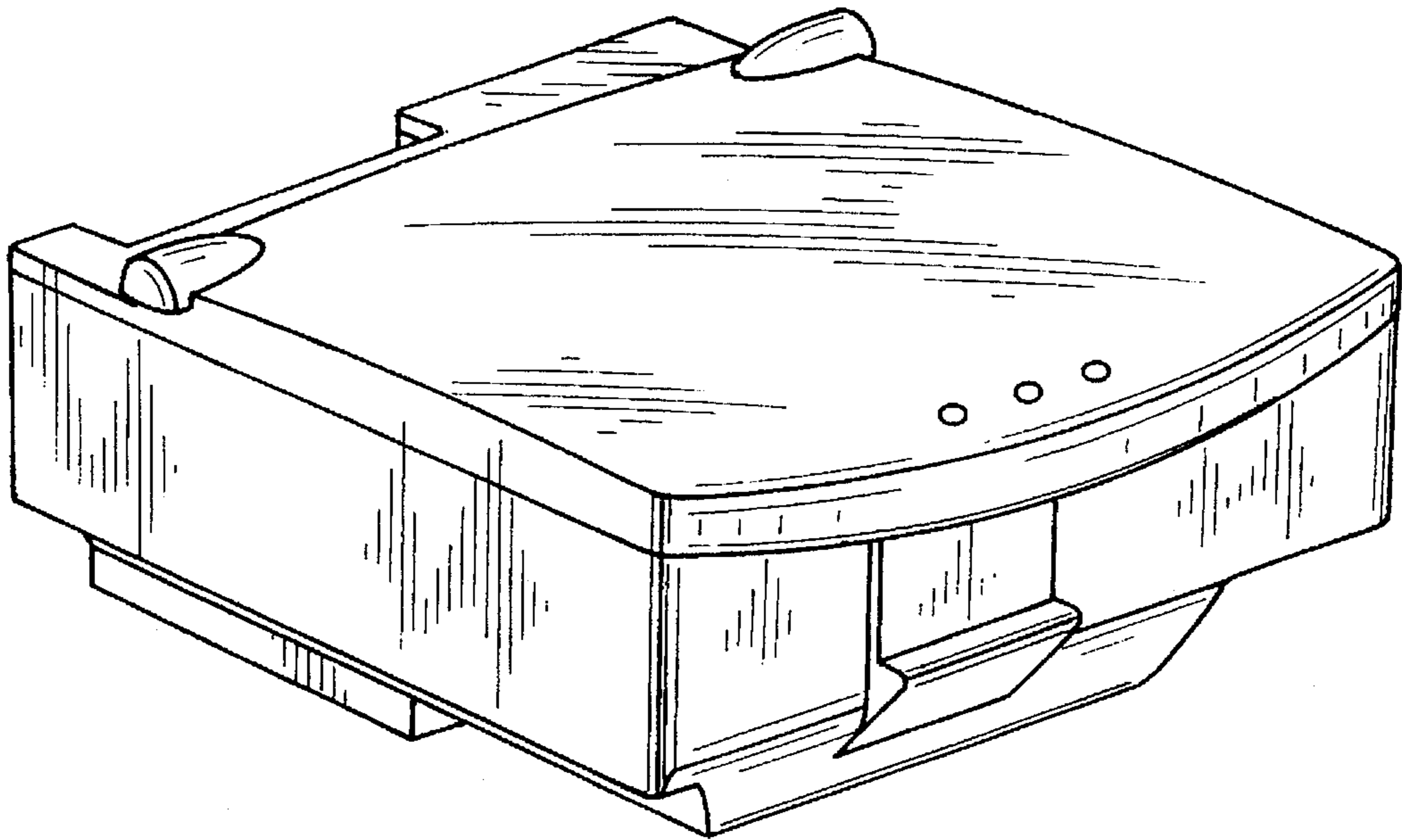

FIG. 1

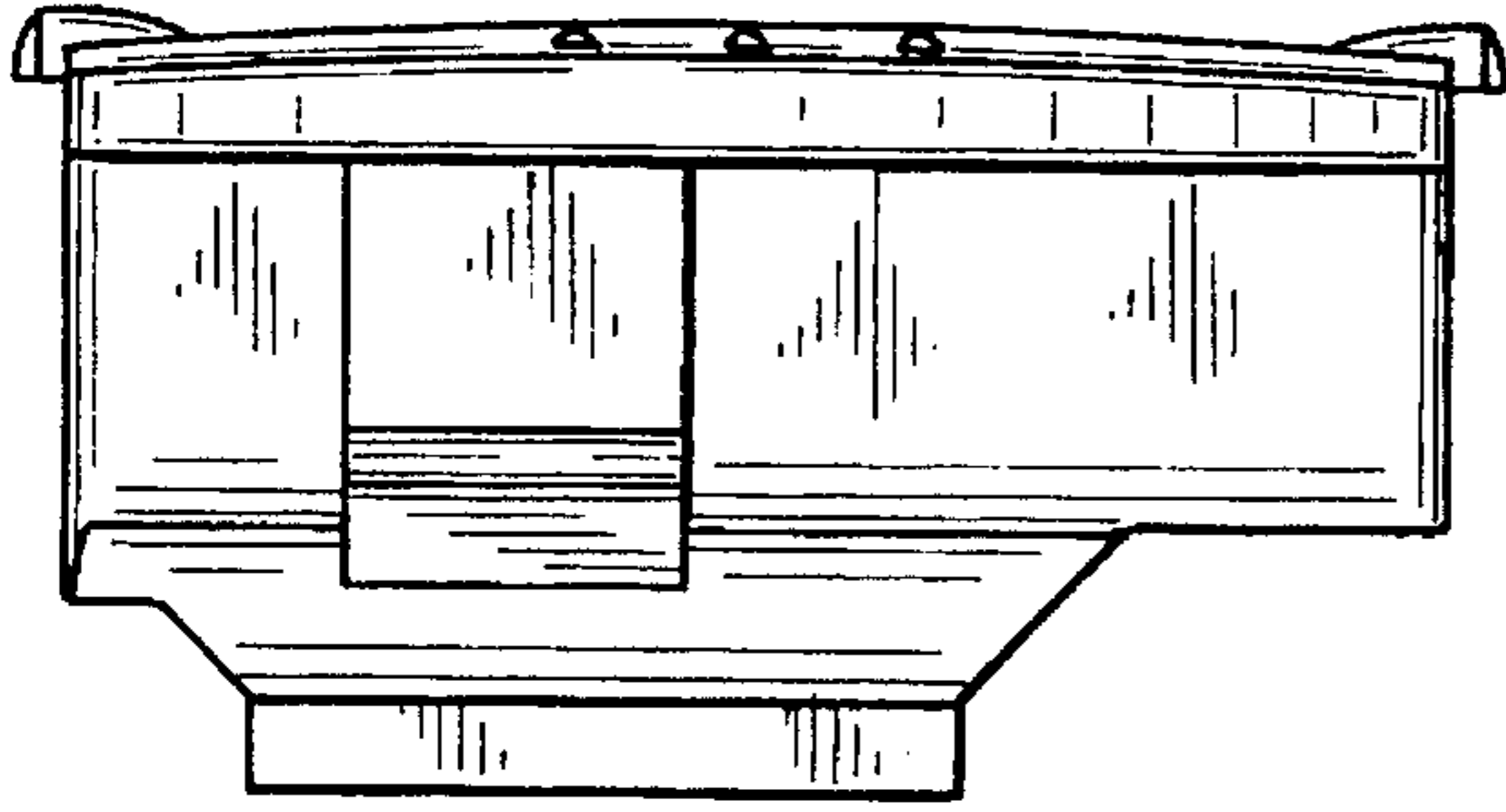

FIG. 2

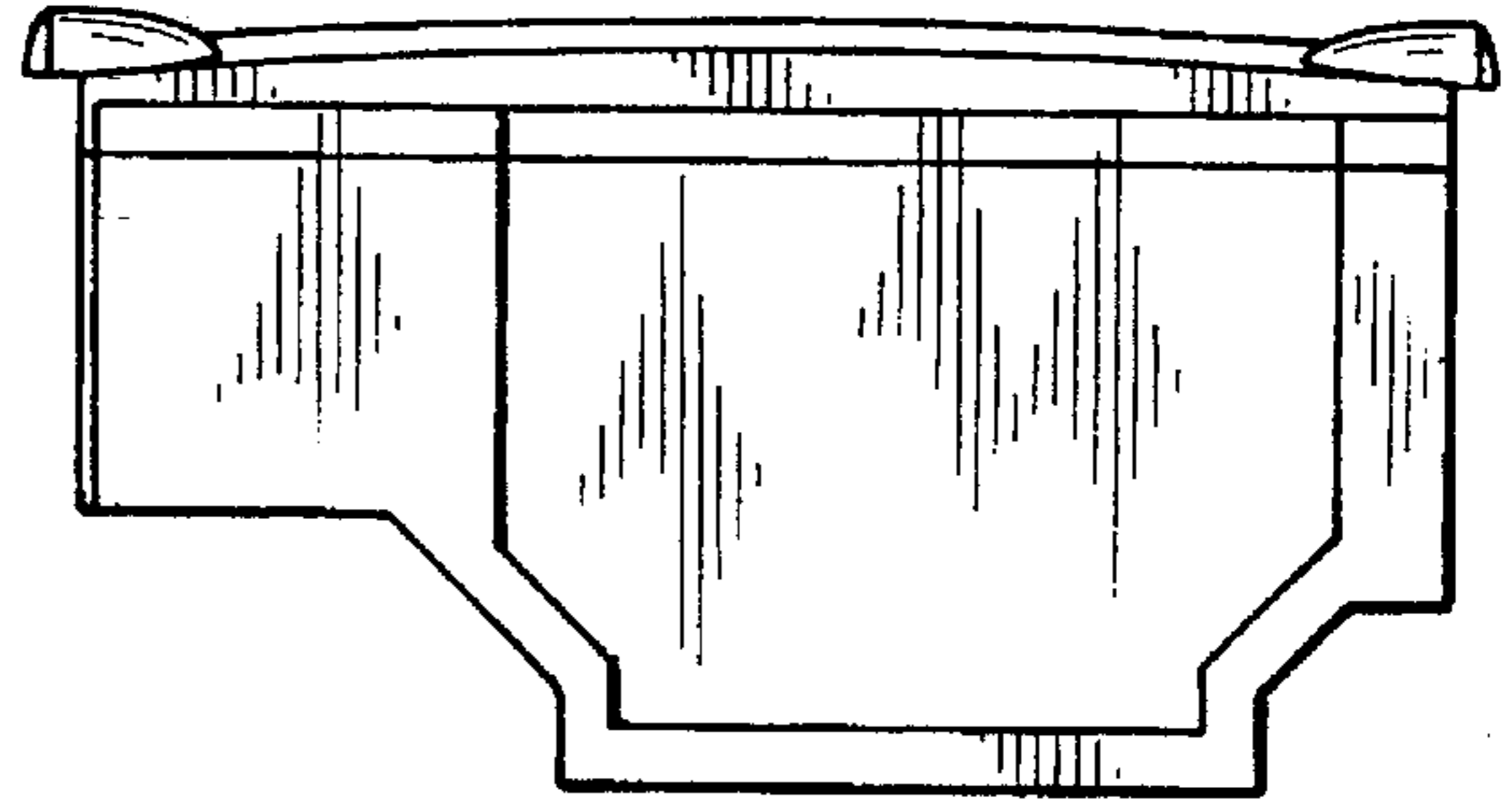

FIG. 3

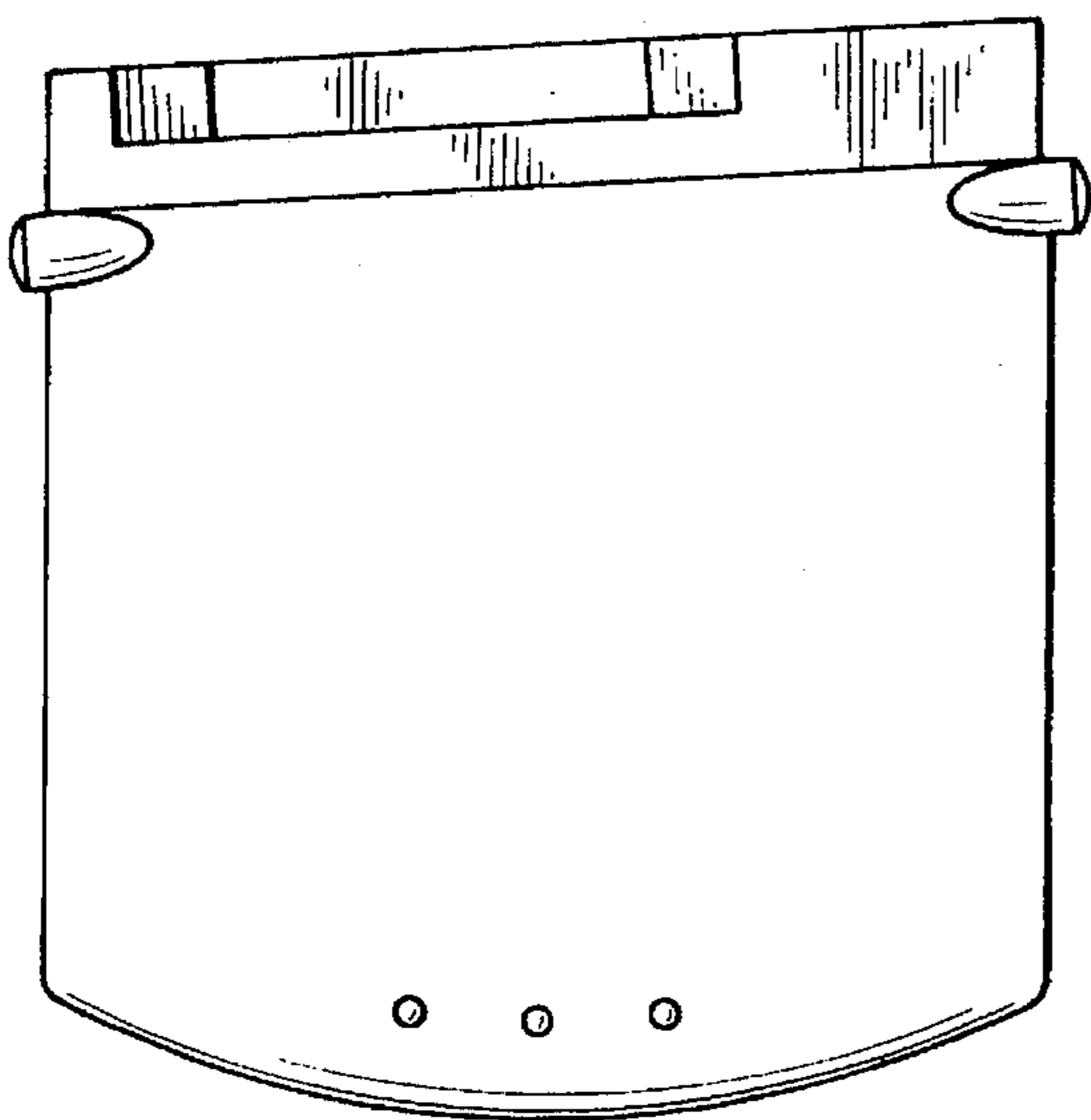

FIG. 4

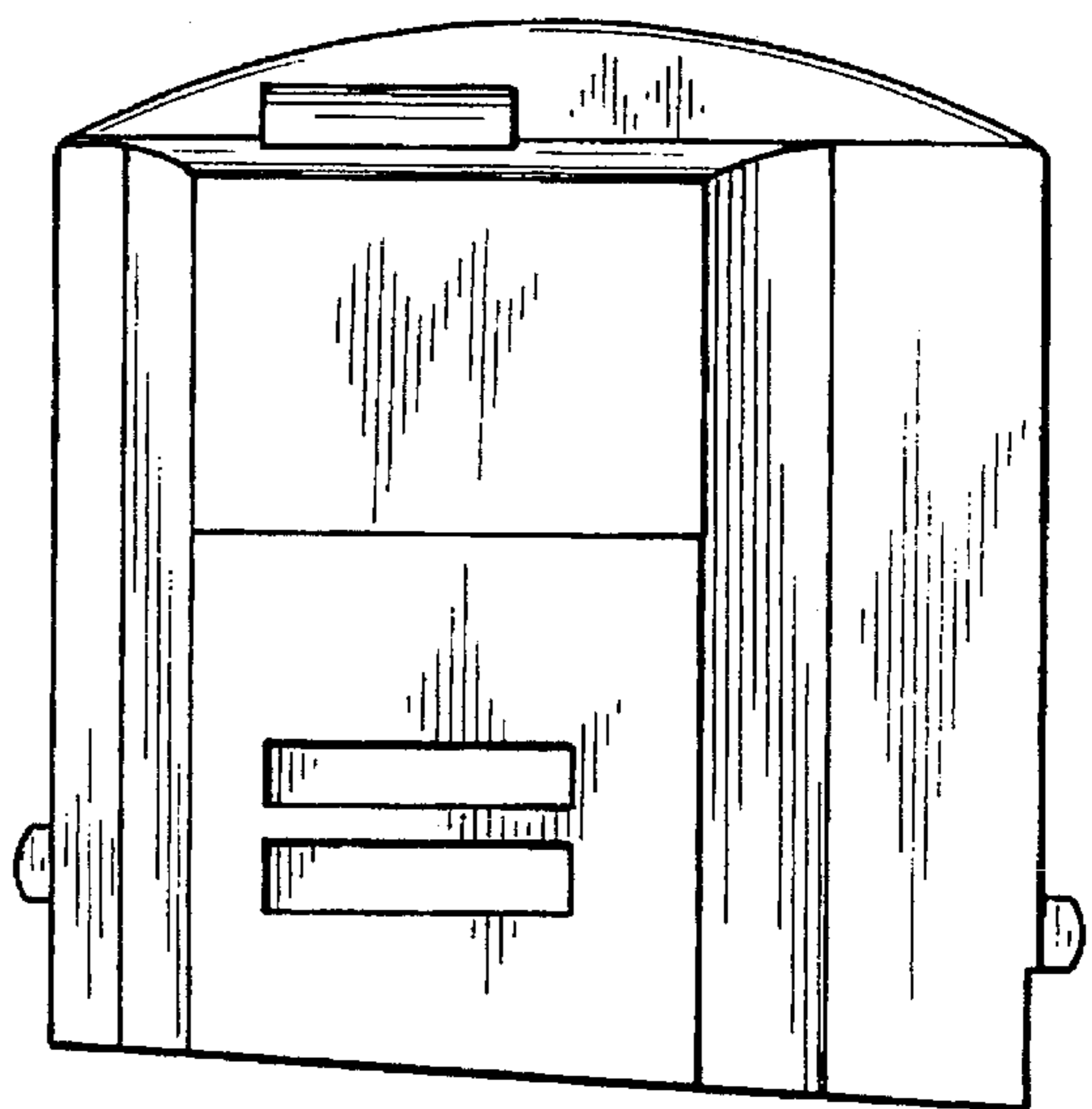

FIG. 5

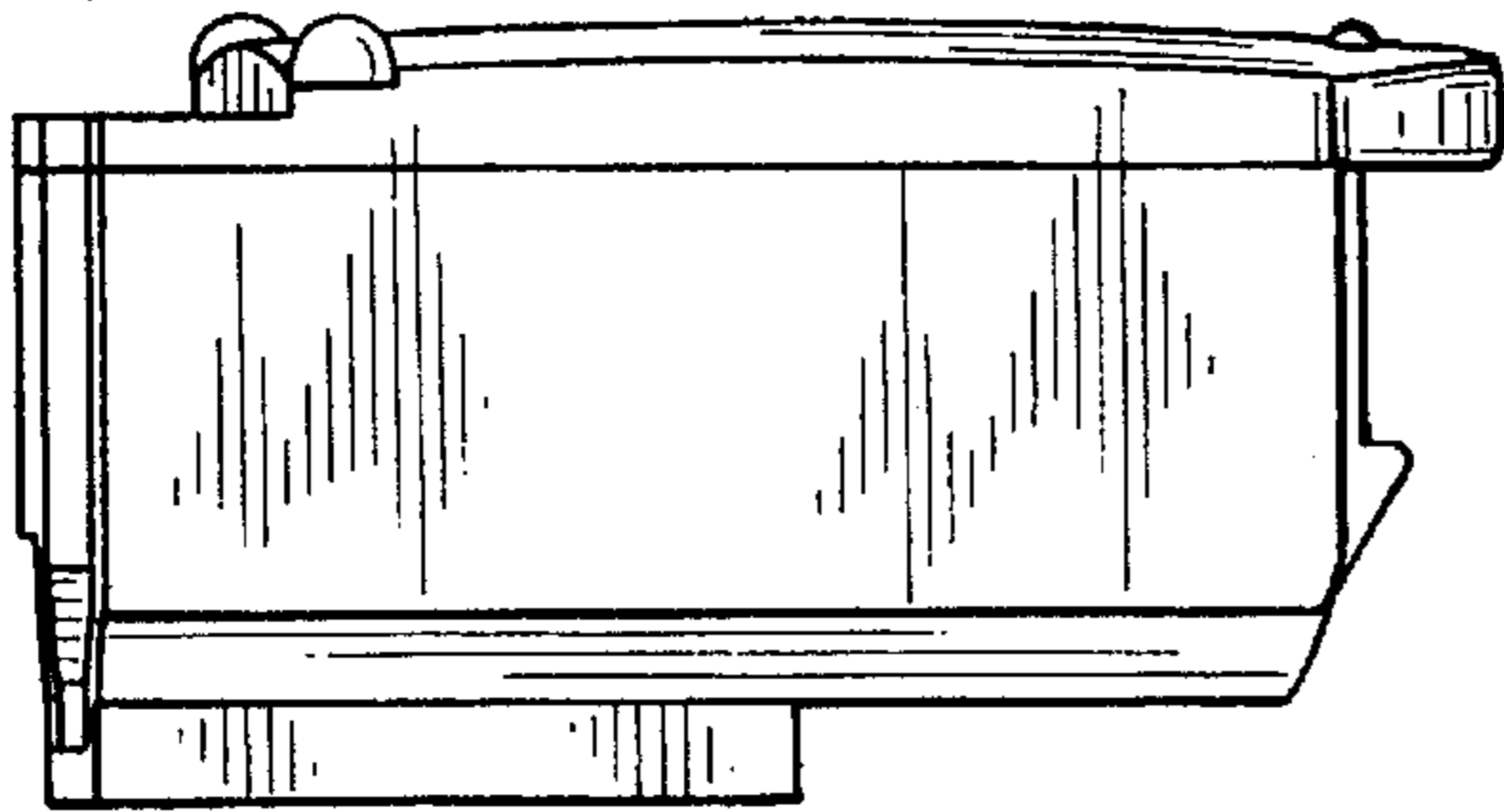

FIG. 6

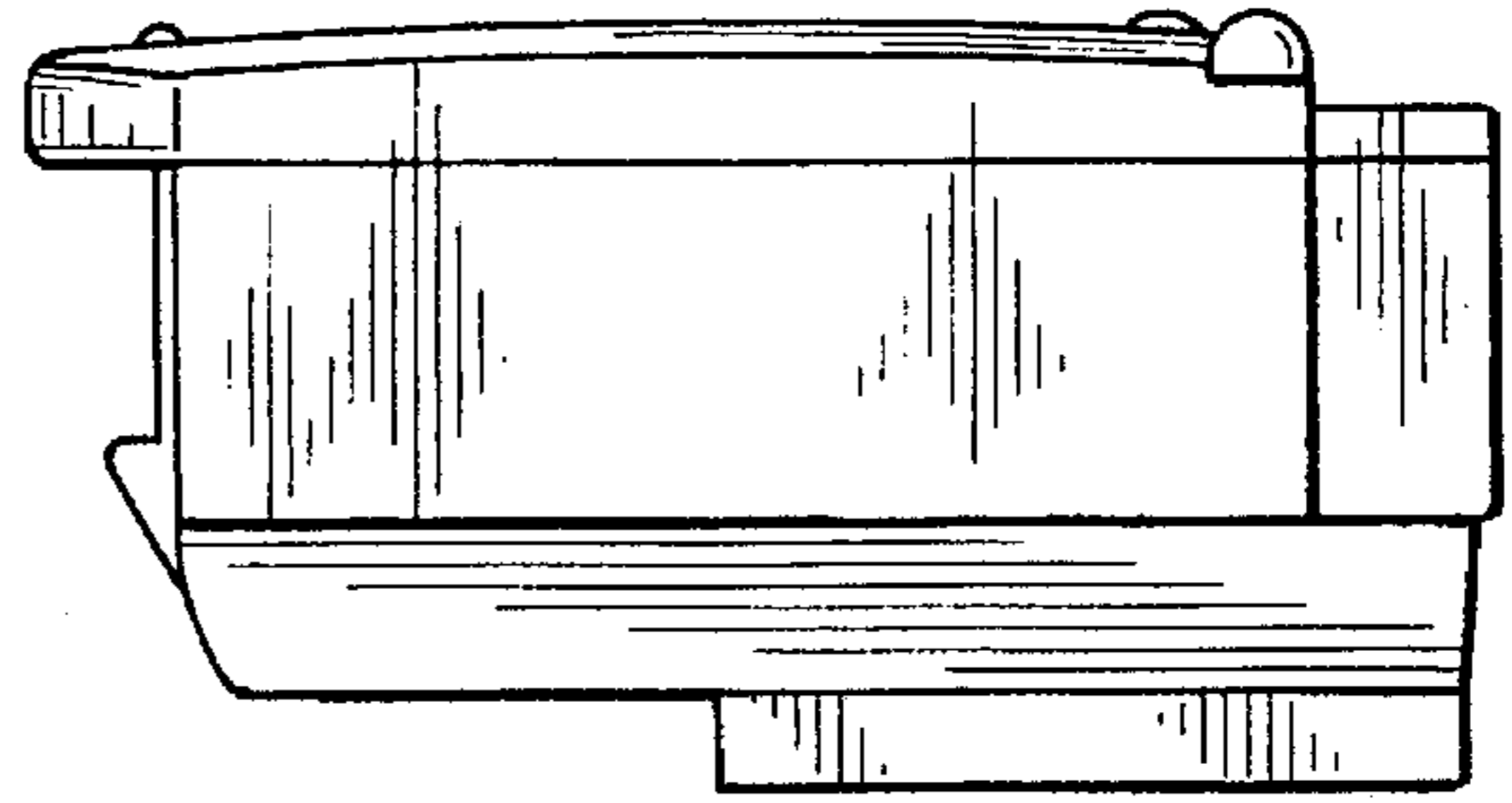

FIG. 7

