



US00D375480S

# United States Patent [19] Smith

[11] Patent Number: **Des. 375,480**

[45] Date of Patent: **\*\*Nov. 12, 1996**

[54] **FLOOR TO SEAT CONSOLE**

[75] Inventor: **Daniel G. Smith**, Grand Prairie, Tex.

[73] Assignee: **Texas Saddlebags, Inc.**, Arlington, Tex.

[\*\*] Term: **14 Years**

[21] Appl. No.: **32,775**

[22] Filed: **Dec. 28, 1994**

[52] U.S. Cl. .... **D12/419**; D12/424

[58] Field of Search ..... D12/419, 423,  
D12/424; 224/536-539, 37.1, 37.6

[56] **References Cited**

**U.S. PATENT DOCUMENTS**

D. 352,495	11/1994	Mawhinney et al. ....	D12/419
D. 359,266	6/1995	Karp et al. ....	D12/419
4,796,791	1/1989	Goss et al. ....	224/539
4,809,897	3/1989	Wright, Jr. ....	224/539

*Primary Examiner*—Melody N. Brown  
*Attorney, Agent, or Firm*—Daniel Rubin

[57] **CLAIM**

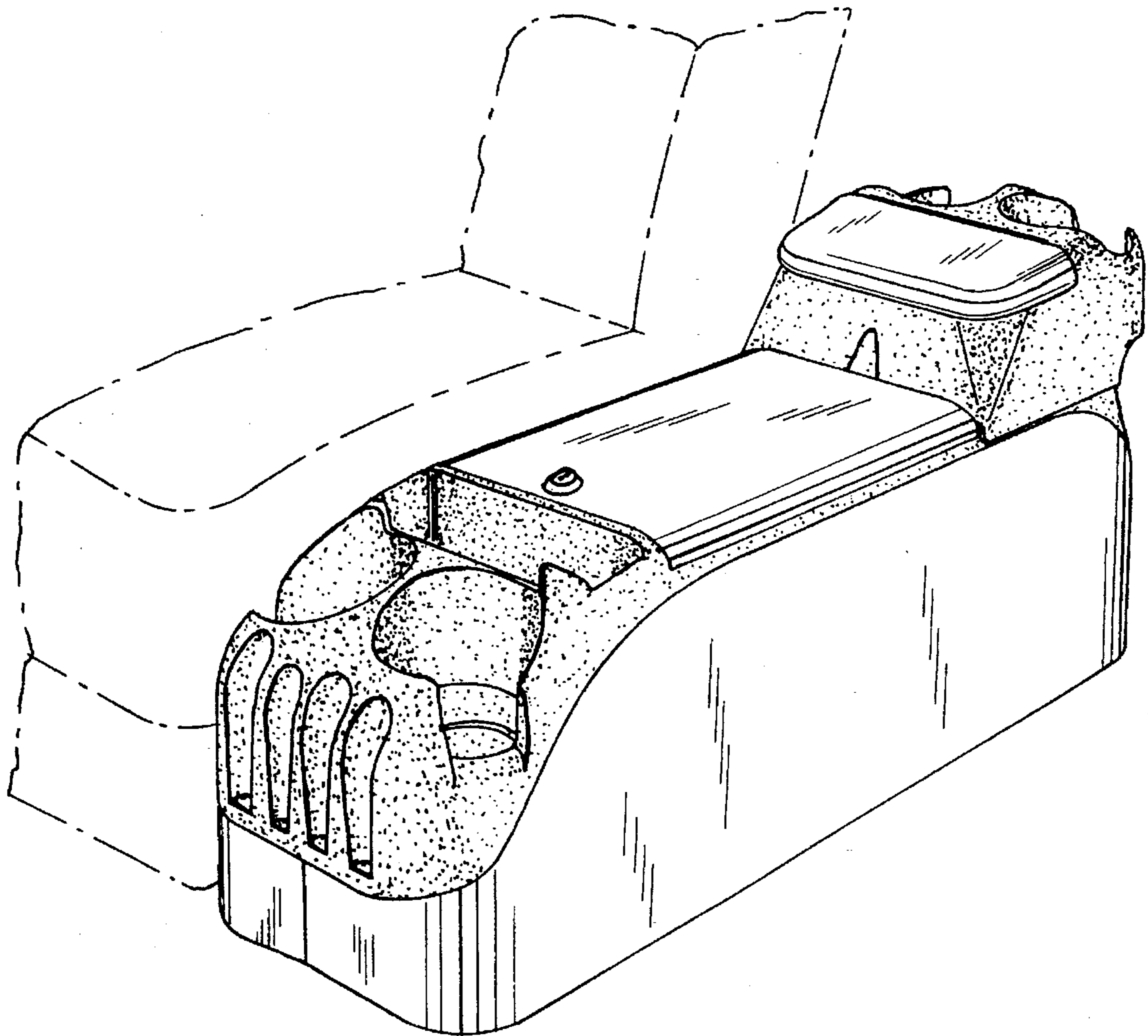
The ornamental design of a floor to seat console, as shown and described.

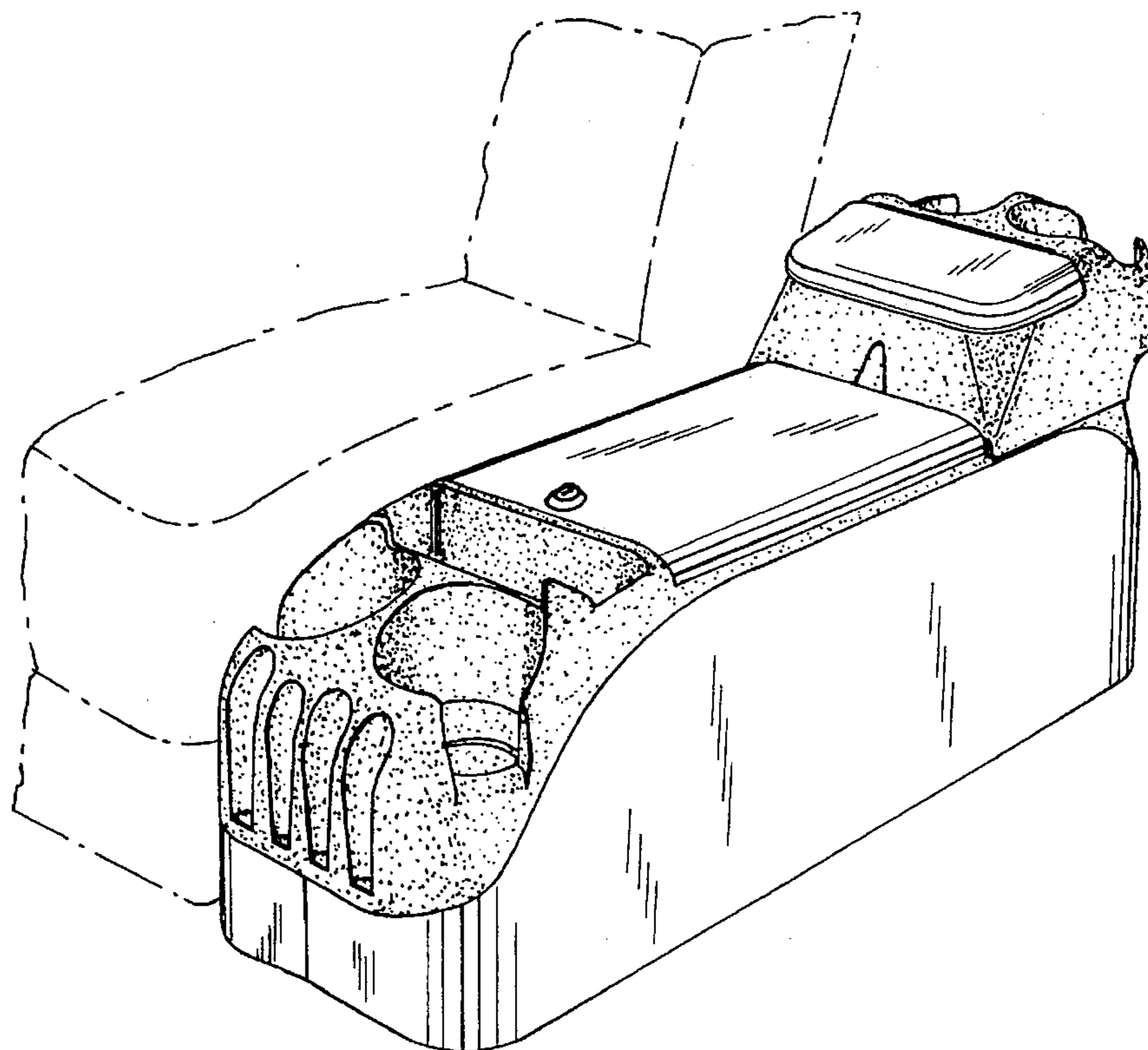
**DESCRIPTION**

FIG. 1 is a top and front perspective view of a floor to seat console showing my new design, the broken lines are shown for illustrative purposes only and form no part of the claimed design;

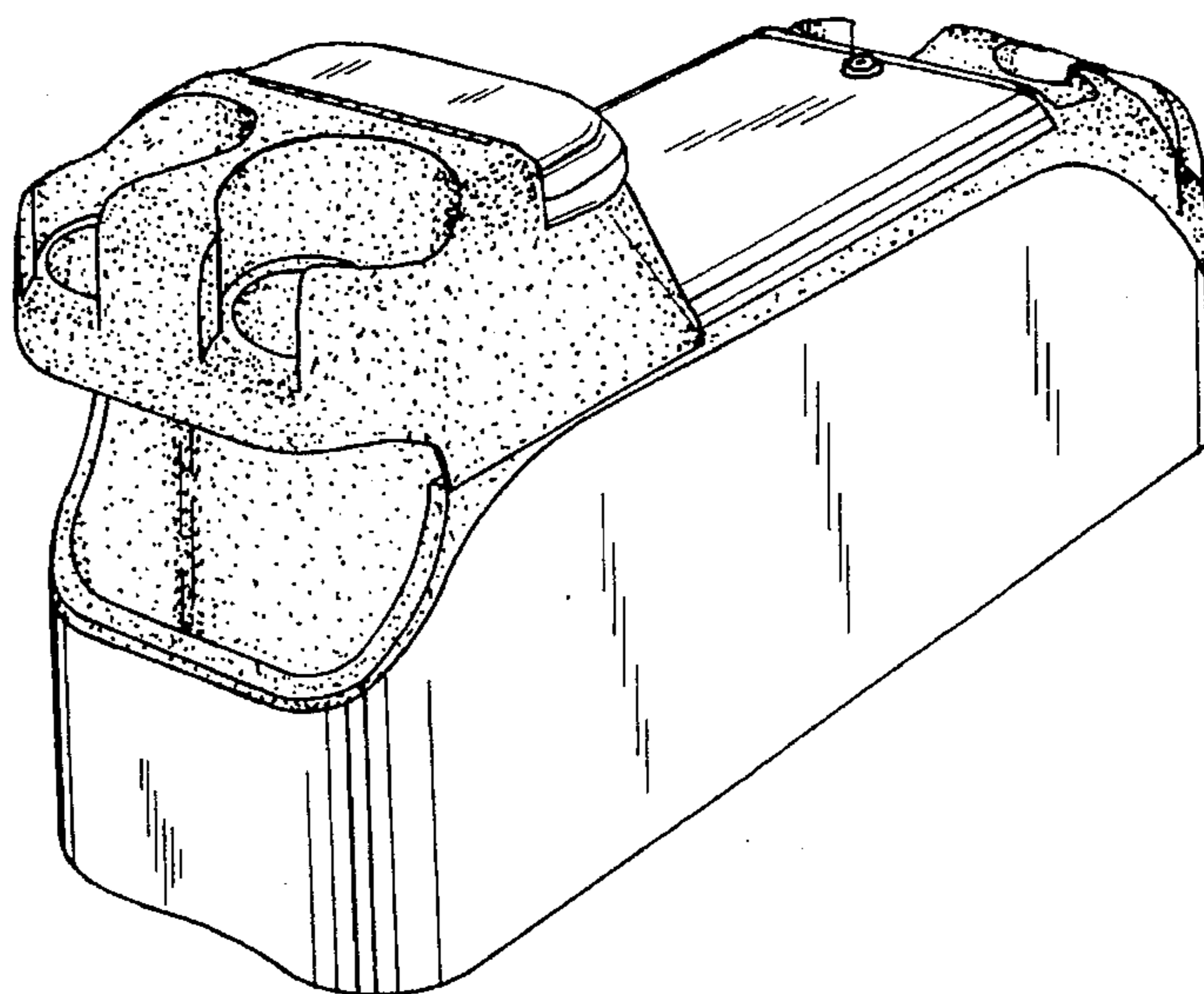
FIG. 2 is a top and rear perspective thereof;  
FIG. 3 is a left side elevational view thereof;  
FIG. 4 is a right side elevational view thereof;  
FIG. 5 is a front elevational view thereof;  
FIG. 6 is a rear elevational view thereof;  
FIG. 7 is a top plan view thereof; and,  
FIG. 8 is a bottom plan view thereof.

**1 Claim, 3 Drawing Sheets**

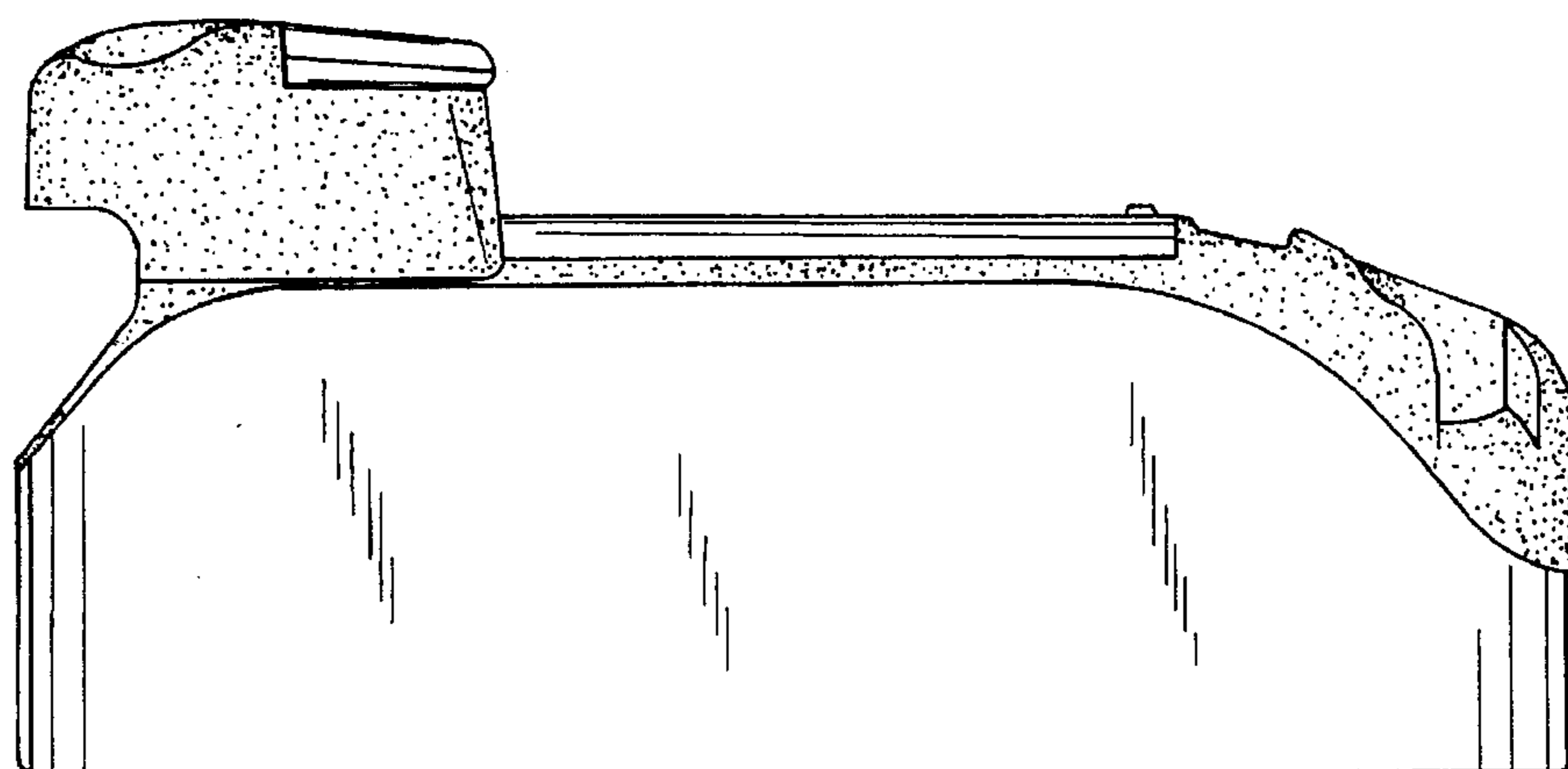




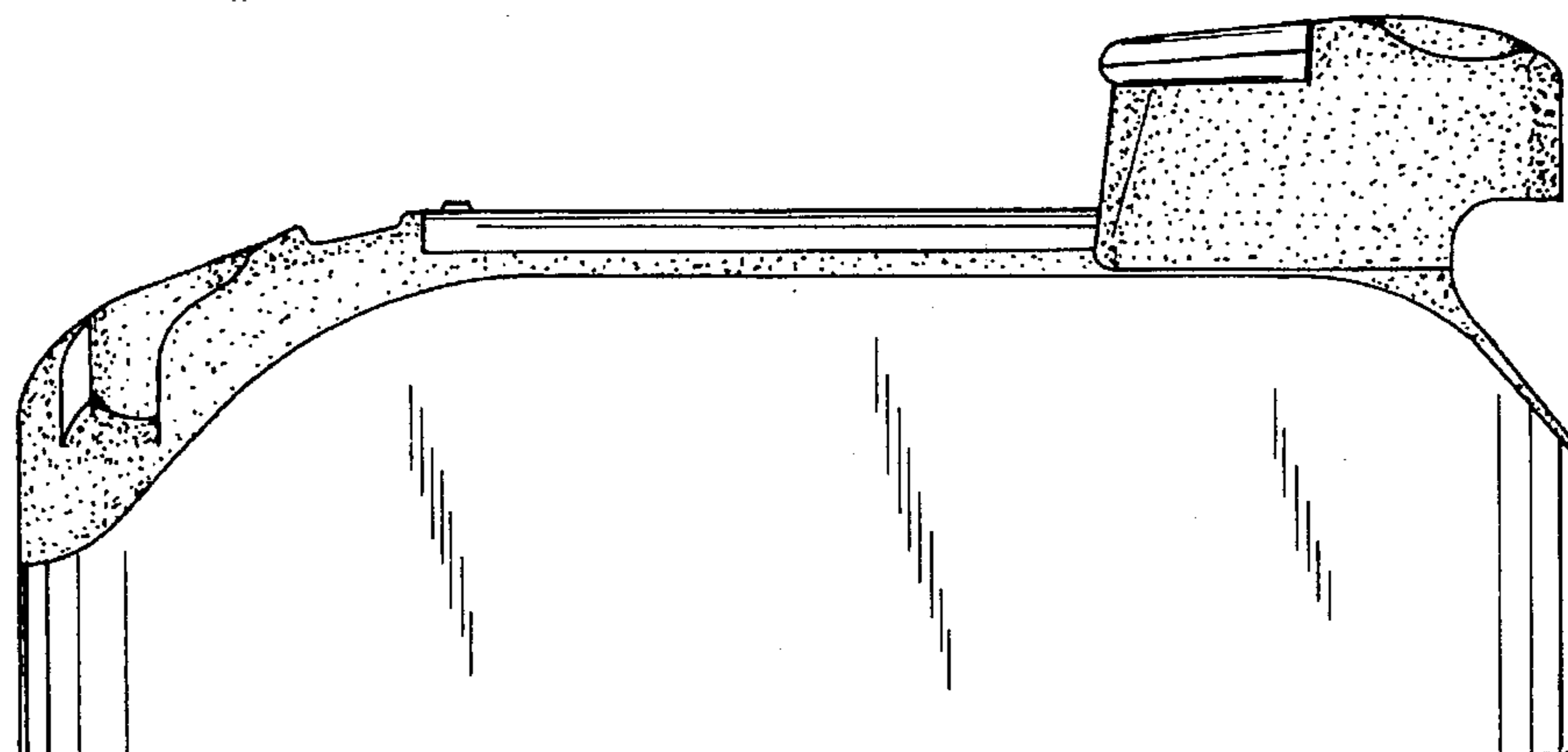
*Fig. 1*



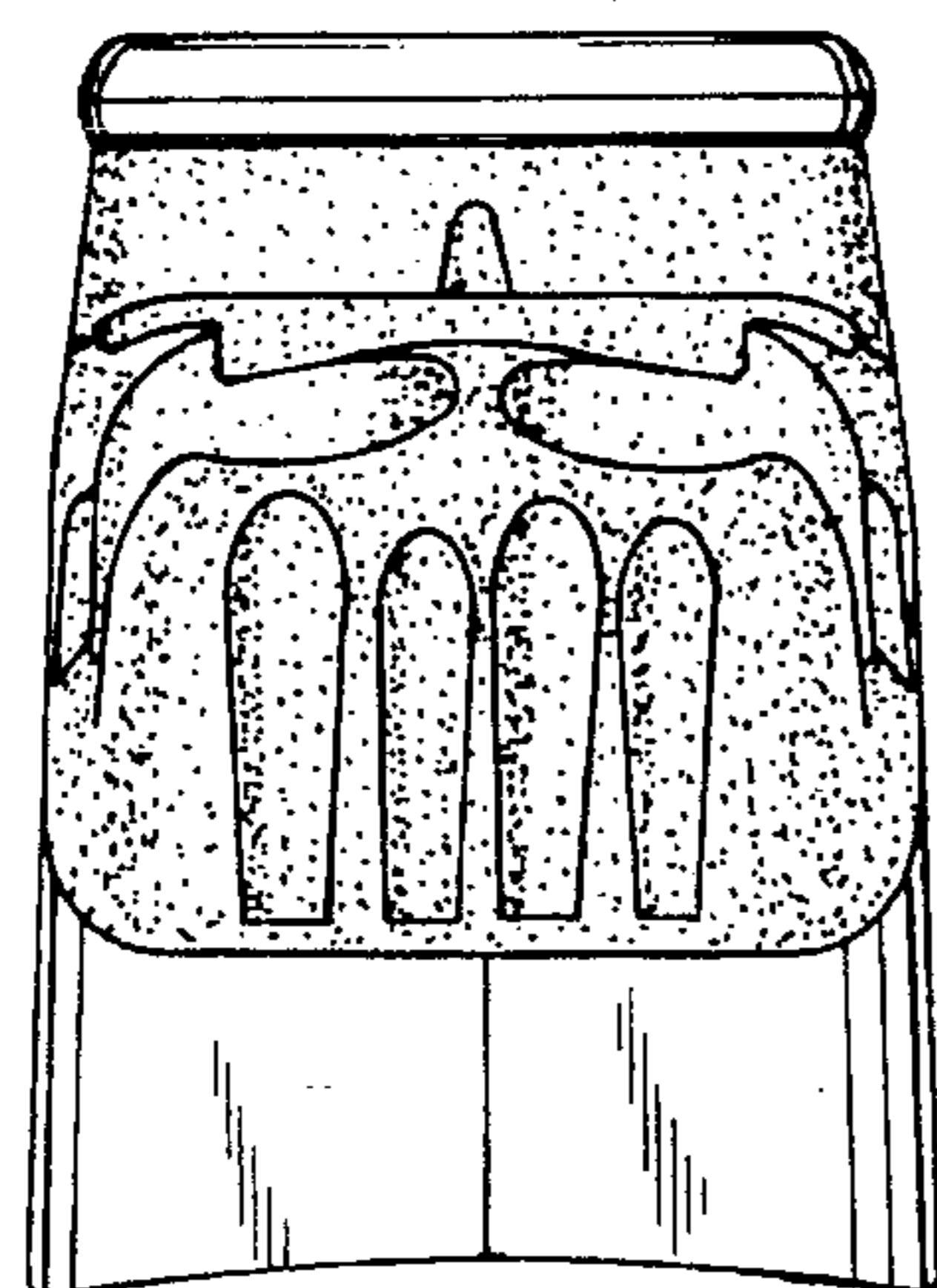
*Fig. 2*



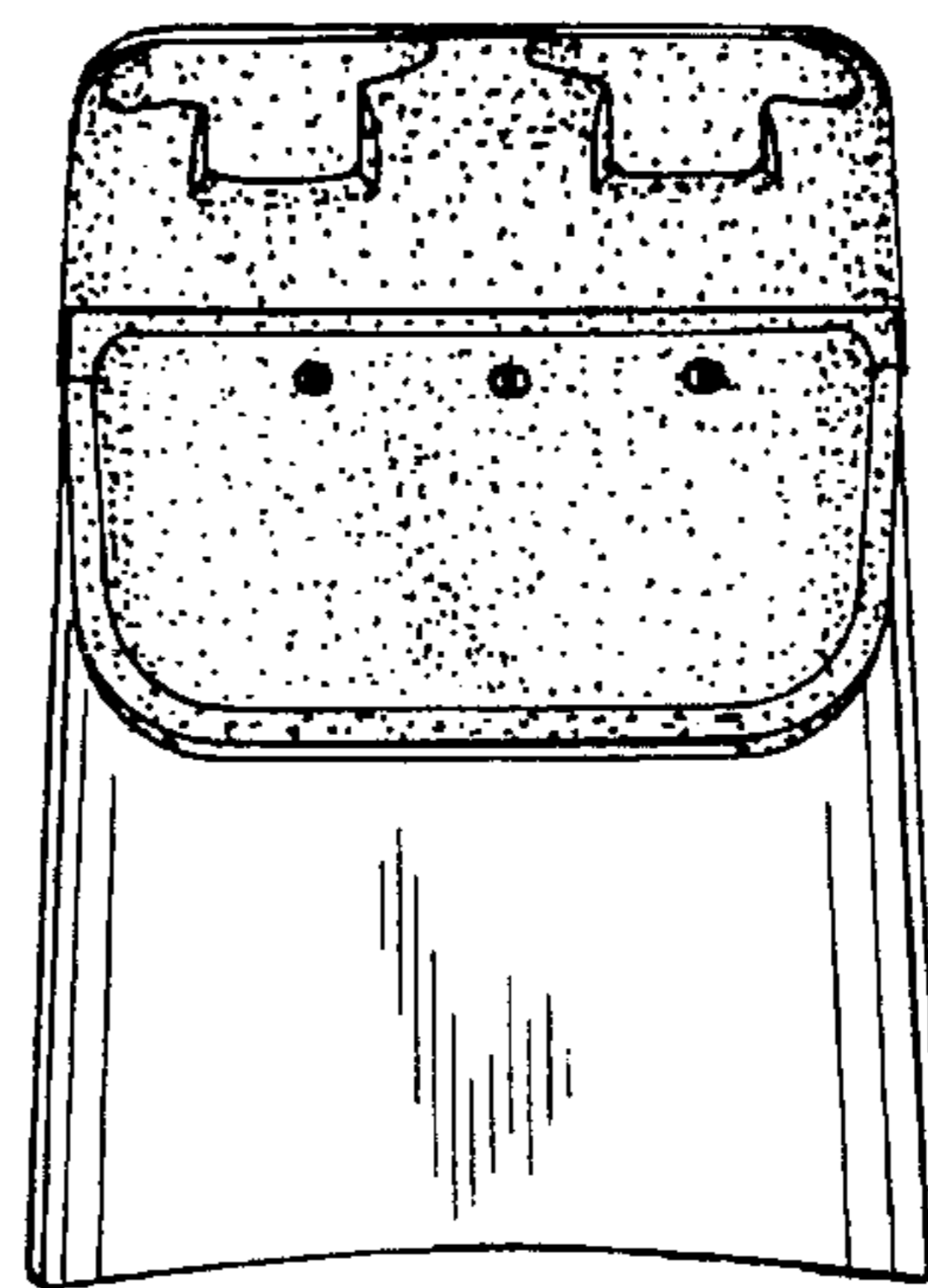
**Fig. 3**



**Fig. 4**

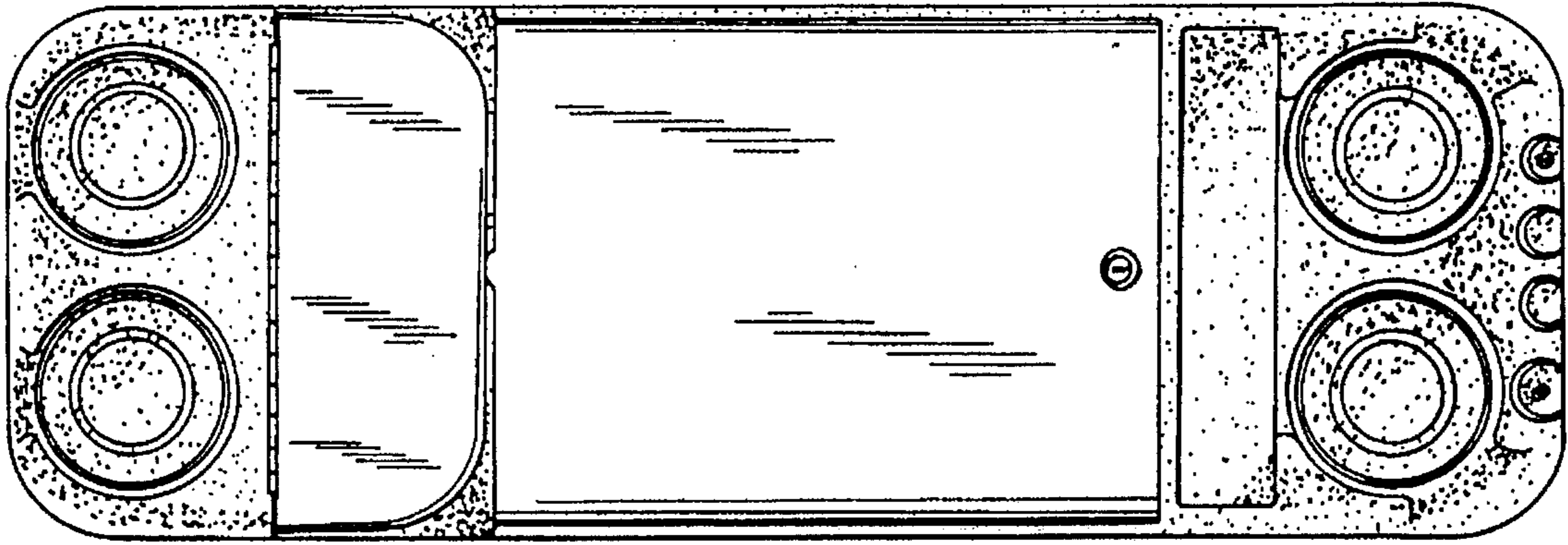


**Fig. 5**

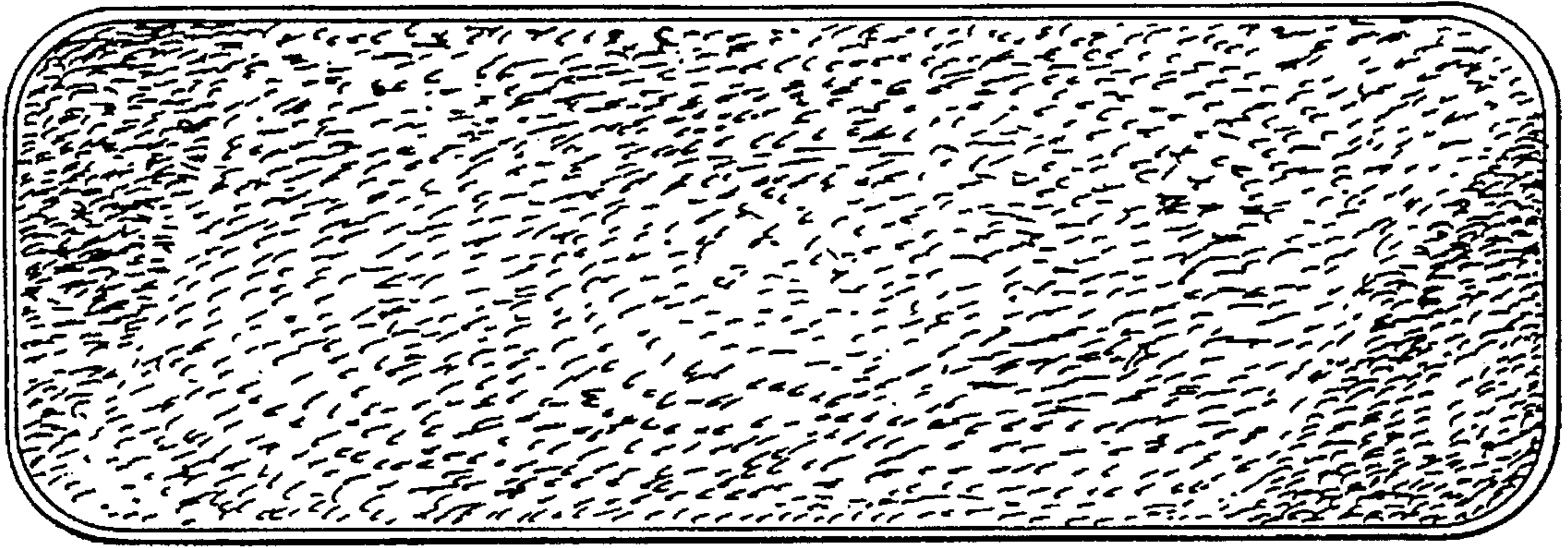


**Fig. 6**





*Fig. 7*



*Fig. 8*