



US00D375275S

United States Patent [19] Suzuki

[11] Patent Number: **Des. 375,275**

[45] Date of Patent: ****Nov. 5, 1996**

[54] **AUDIBLE SIGNAL FOR ALARM UNITS**

[75] Inventor: **Kazushi Suzuki**, Shizuoka, Japan

[73] Assignee: **Star Micronics Co., Ltd.**,
Shizuoka-ken, Japan

[**] Term: **14 Years**

[21] Appl. No.: **35,991**

[22] Filed: **Mar. 10, 1995**

[30] **Foreign Application Priority Data**

Sep. 24, 1994 [JP] Japan 6-28830

[52] U.S. Cl. **D10/116**

[58] Field of Search D10/104, 106,
D10/116, 117, 118, 121; 340/384.1, 384.3,
384.7, 388.1, 390.1, 391.1, 392.1, 392.2,
392.4, 407.1; D13/152, 156

[56] **References Cited**

U.S. PATENT DOCUMENTS

D. 201,593	7/1965	Stevenson	D10/118
D. 264,196	5/1982	Doggart	D10/118
D. 339,544	9/1993	Sone	.	
D. 350,705	9/1994	Sone	.	
2,984,832	5/1961	Gilman, III et al.	340/392
3,251,056	5/1966	Doggart	340/392
4,075,626	2/1978	Sakaguchi et al.	340/392
4,115,770	9/1978	Kanazawa	340/392
4,303,908	12/1981	Enemark et al.	340/384 E
4,366,472	12/1982	Ishii	340/392

Primary Examiner—Marcus A. Jackson
Attorney, Agent, or Firm—Pollock, Vande Sande & Priddy

[57] **CLAIM**

The ornamental design for an audible signal for alarm units, as shown and described.

DESCRIPTION

FIG. 1 is a perspective view of an audible signal for alarm units showing my new design;
 FIG. 2 is a front elevational view thereof;
 FIG. 3 is a rear elevational view thereof;
 FIG. 4 is a top plan view thereof;
 FIG. 5 is a bottom plan view thereof;
 FIG. 6 is a left side elevational view thereof (of which a right side elevational view would be a mirror image);
 FIG. 7 is a cross-sectional view thereof taken on line 7—7 of FIG. 2, an internal mechanism of which is not shown;
 FIG. 8 is a cross-sectional view thereof taken on line 8—8 of FIG. 5, an internal mechanism of which is not shown;
 FIG. 9 is a cross-sectional view thereof taken on line 9—9 of FIG. 5, an internal mechanism of which is not shown; and,
 FIG. 10 is a cross-sectional view thereof taken on line 10—10 of FIG. 5, an internal mechanism of which is not shown; and
 FIG. 11 is a cross-sectional view thereof taken on line 11—11 of FIG. 5, an internal mechanism of which is not shown.

1 Claim, 7 Drawing Sheets

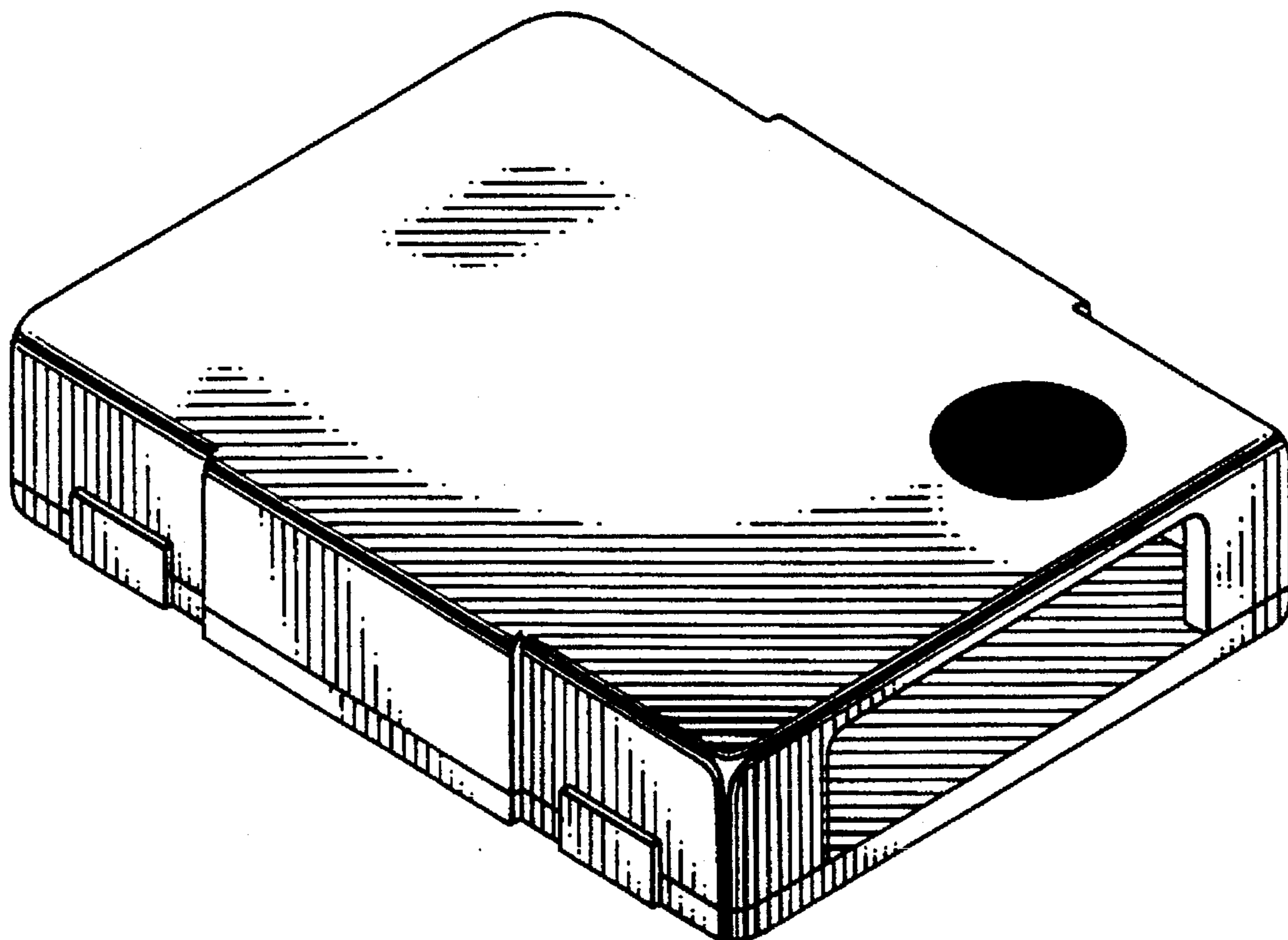

FIG. 1

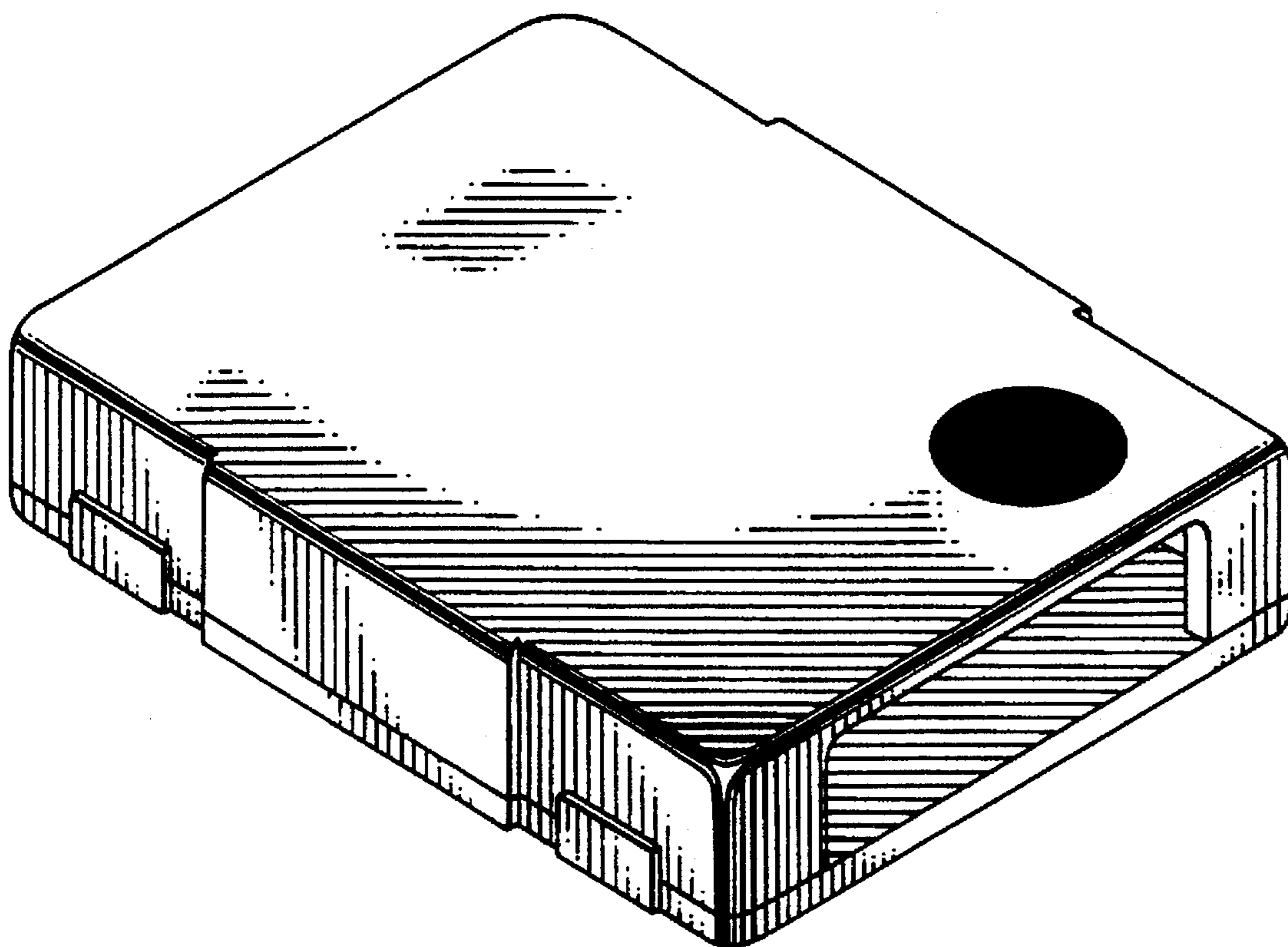

FIG. 2

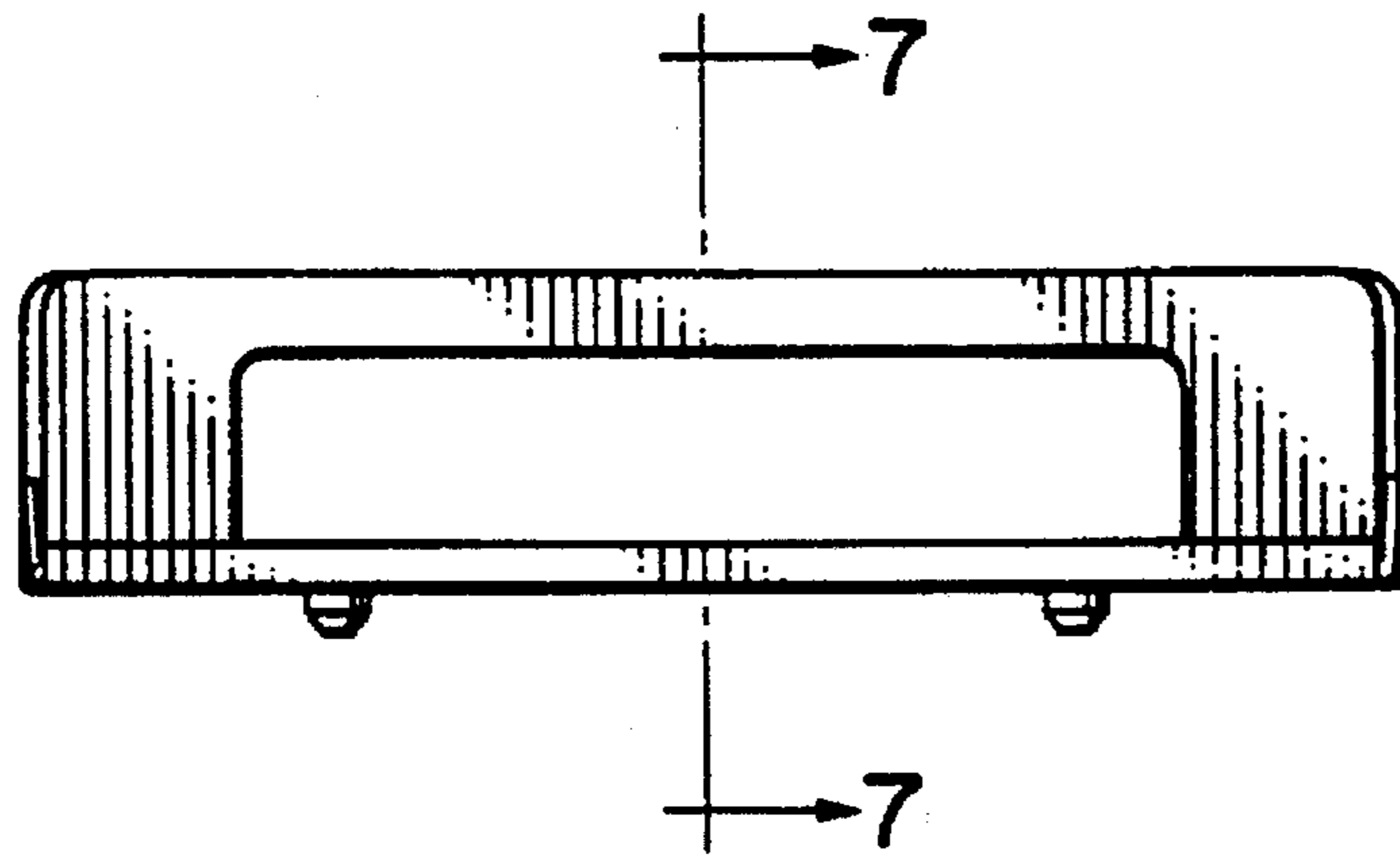

FIG. 3

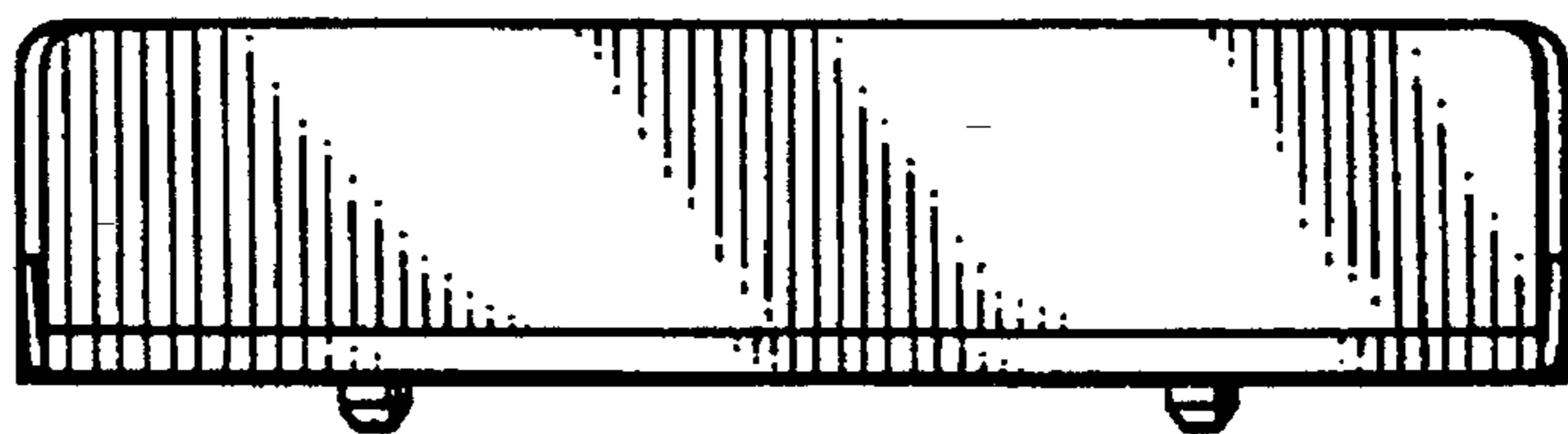

FIG. 4

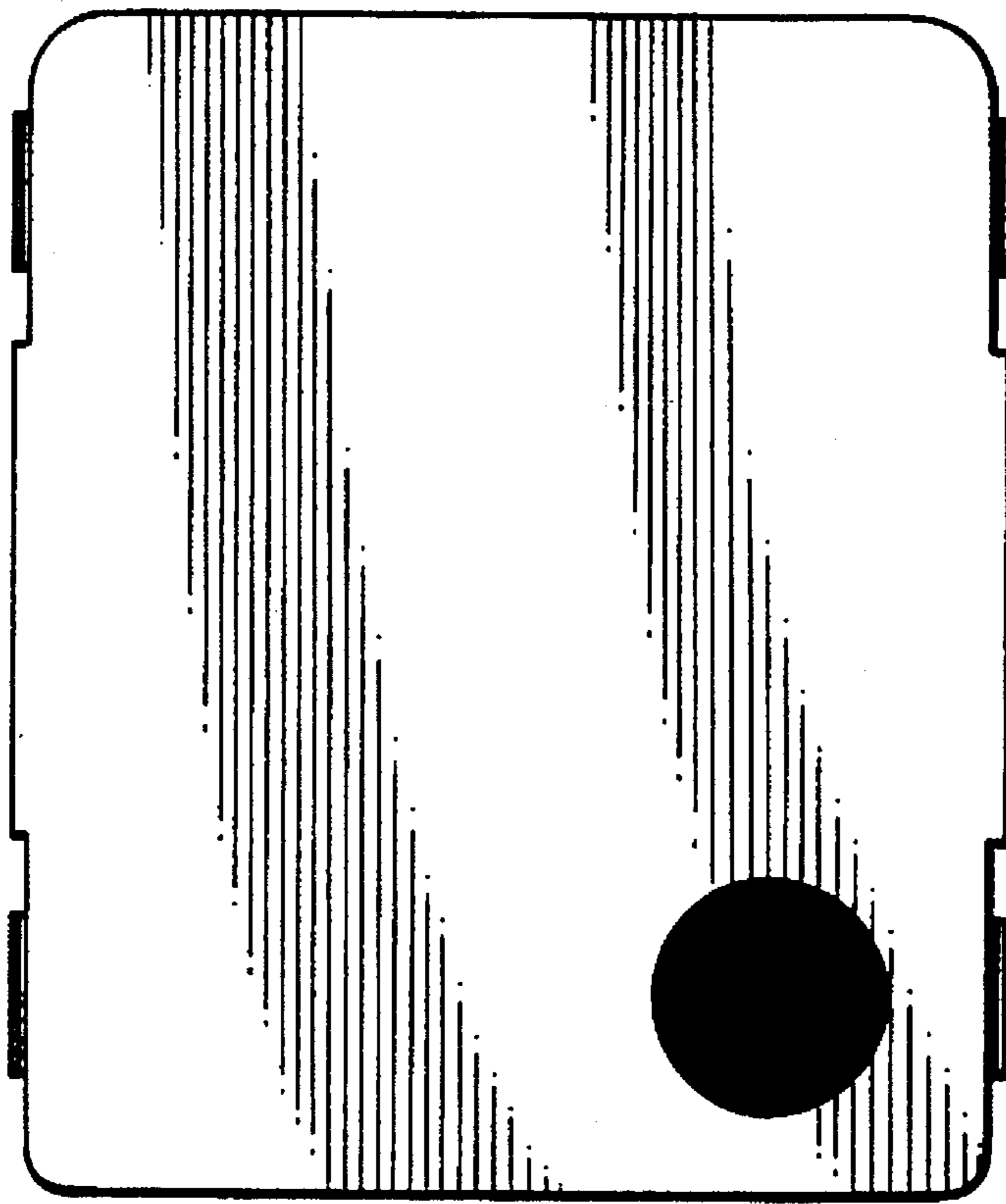

FIG. 5

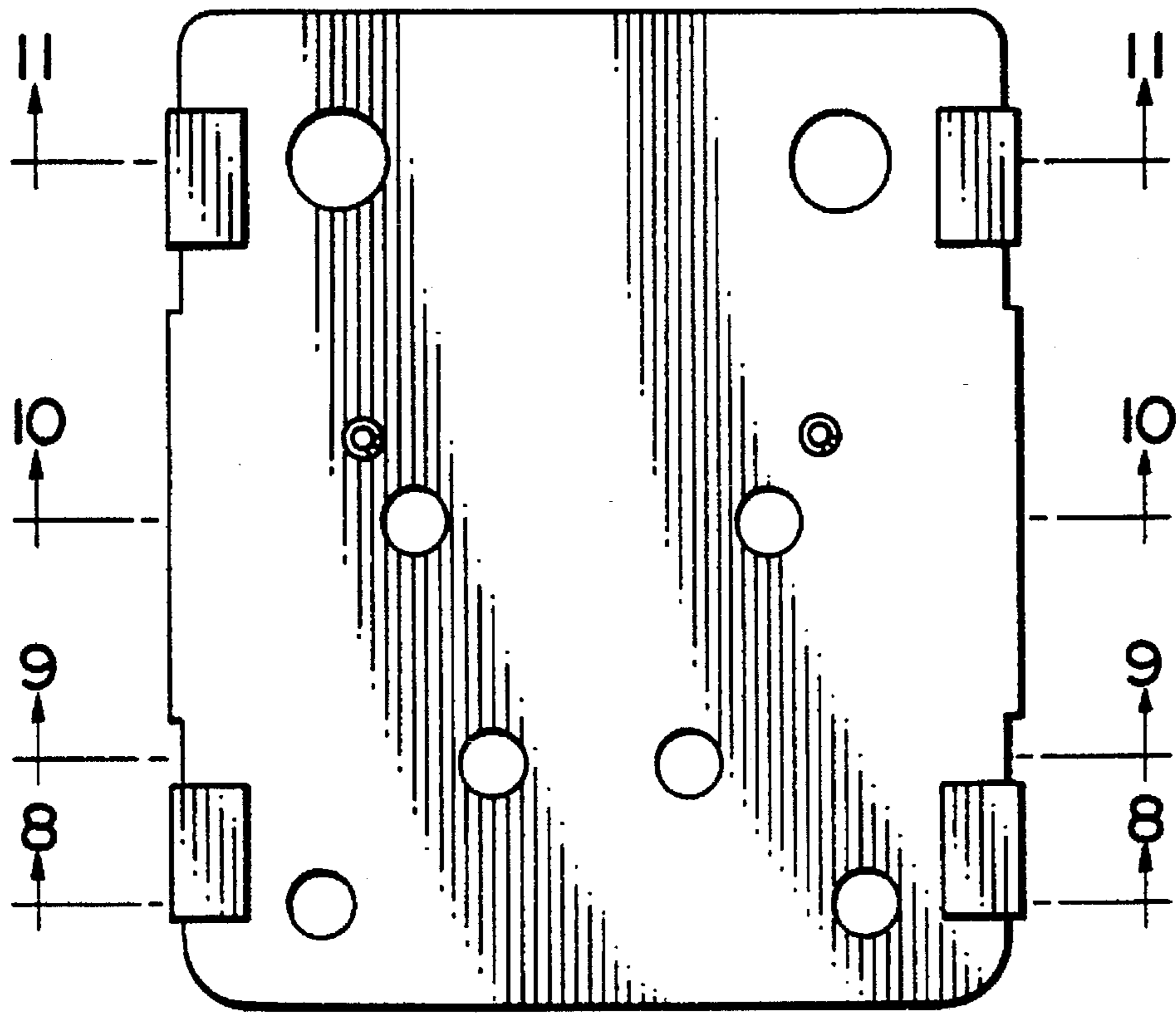

FIG. 6

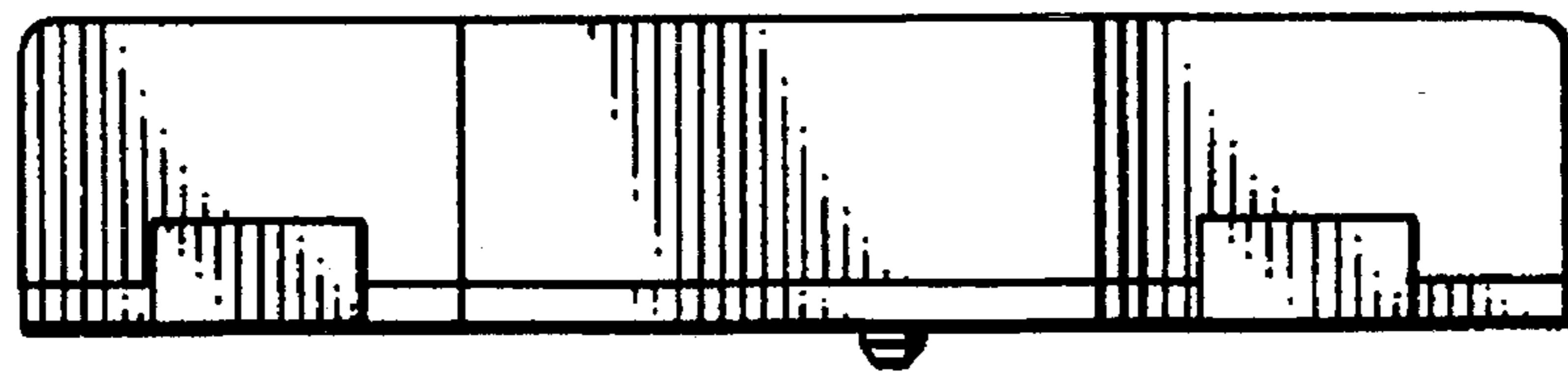

FIG. 7

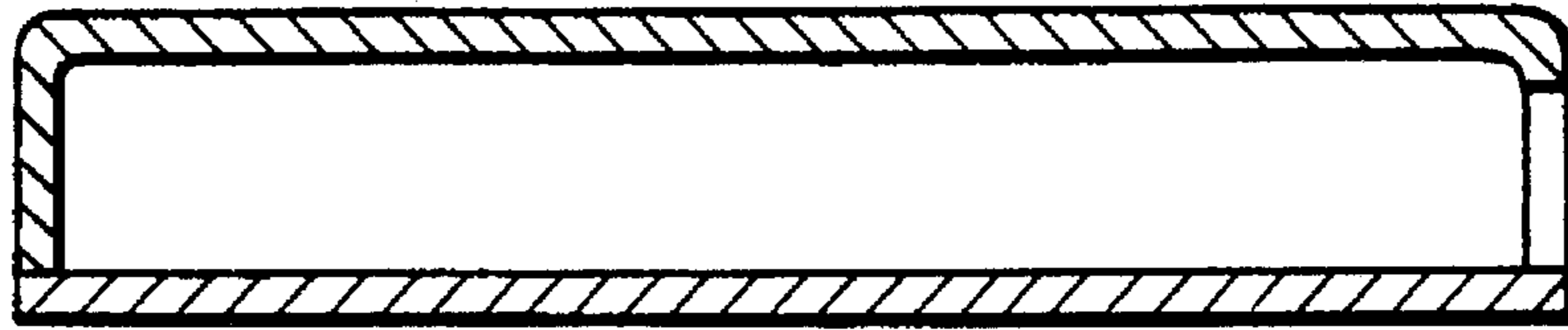

FIG. 8

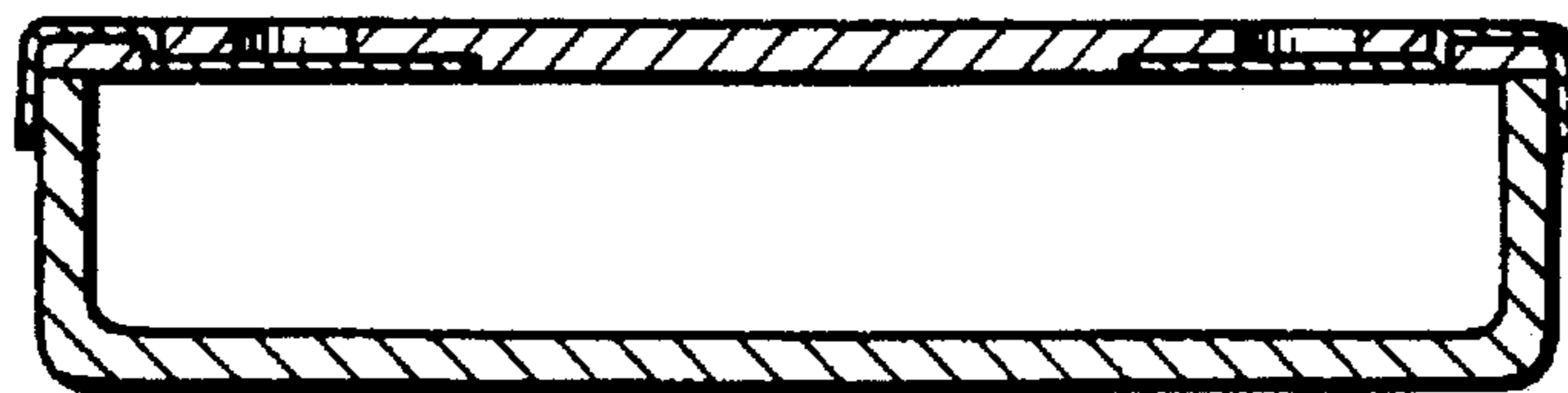

FIG. 9

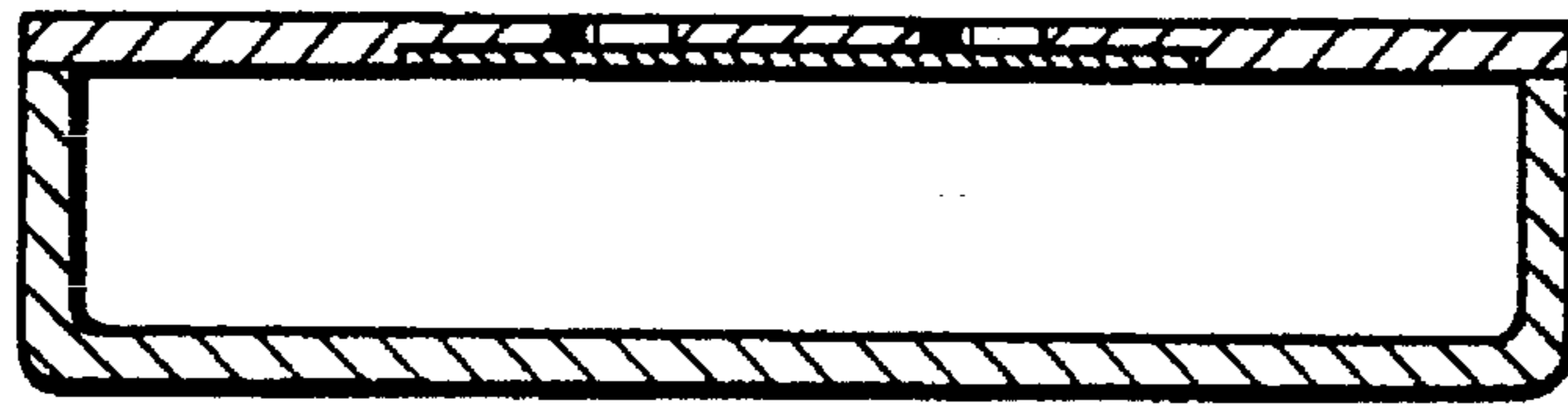

FIG. 10

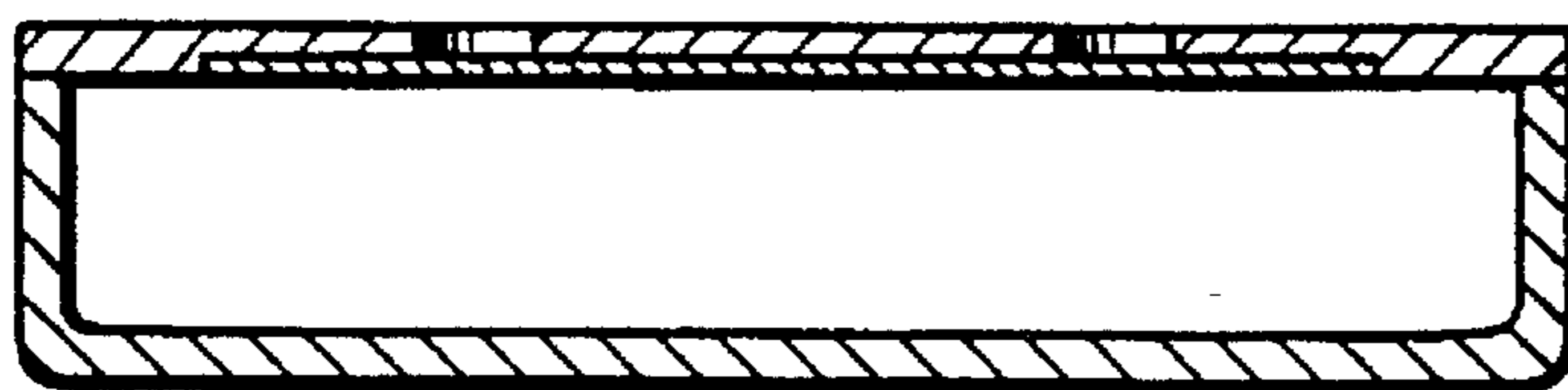

FIG. II

