



US00D375225S

United States Patent [19] Cousins

[11] Patent Number: **Des. 375,225**

[45] Date of Patent: ****Nov. 5, 1996**

[54] **STEAMER LID**

[75] Inventor: **Morison S. Cousins**, Winter Park, Fla.

[73] Assignee: **Dart Industries Inc.**, Deerfield, Ill.

[**] Term: **14 Years**

[21] Appl. No.: **45,530**

[22] Filed: **Oct. 23, 1995**

[52] U.S. Cl. **D7/391**

[58] Field of Search D7/391, 393, 396.1;
99/339, 361, 410, 416, 103

[56] **References Cited**

U.S. PATENT DOCUMENTS

D. 118,445	1/1940	Gardner	D7/361
D. 122,775	10/1940	Hoople	.	
D. 134,334	11/1942	Kapner et al.	D7/361 X
D. 159,918	8/1950	Muller-Munk	D7/361
D. 160,647	10/1950	Muller-Munk	D7/391
D. 160,648	10/1950	Muller-Munk	D7/391
D. 261,215	10/1981	Groh et al.	D7/391
D. 261,348	10/1981	Groh et al.	D7/391
D. 324,626	3/1992	Giugiaro	.	
D. 330,309	10/1992	Minuti	.	
607,046	8/1948	Greenwood et al.	.	
1,397,302	3/1921	Georges	.	
2,821,740	2/1958	Heller	.	

Primary Examiner—Louis S. Zarfaz
Assistant Examiner—Frank Martinez
Attorney, Agent, or Firm—John A. Doninger

[57] **CLAIM**

The ornamental design for a steamer lid, as shown and described.

DESCRIPTION

FIG. 1 is a top, front and side perspective view of a steamer lid showing my new design;
FIG. 2 is a top plan view thereof;
FIG. 3 is a bottom plan view thereof;
FIG. 4 is a front elevation view thereof;
FIG. 5 is a rear elevation view thereof;
FIG. 6 is a left side elevation view thereof;
FIG. 7 is a right side elevation view thereof;
FIG. 8 is a cross-section thereof taken on line 8—8 in FIG. 2;
FIG. 9 is a cross-section thereof taken on line 9—9 in FIG. 2;
FIG. 10 is a top, front and side perspective view of a variation thereof;
FIG. 11 is a top plan view of the variation thereof;
FIG. 12 is a bottom plan view of the variation thereof;
FIG. 13 is a front elevation view of the variation thereof;
FIG. 14 is a rear elevation view of the variation thereof;
FIG. 15 is a left side elevation view of the variation thereof;
FIG. 16 is a right side elevation view of the variation thereof;
FIG. 17 is a cross-section of the variation thereof taken on line 17—17 in FIG. 11; and,
FIG. 18 is a cross-section of the variation thereof taken on line 18—18 in FIG. 11.

1 Claim, 8 Drawing Sheets

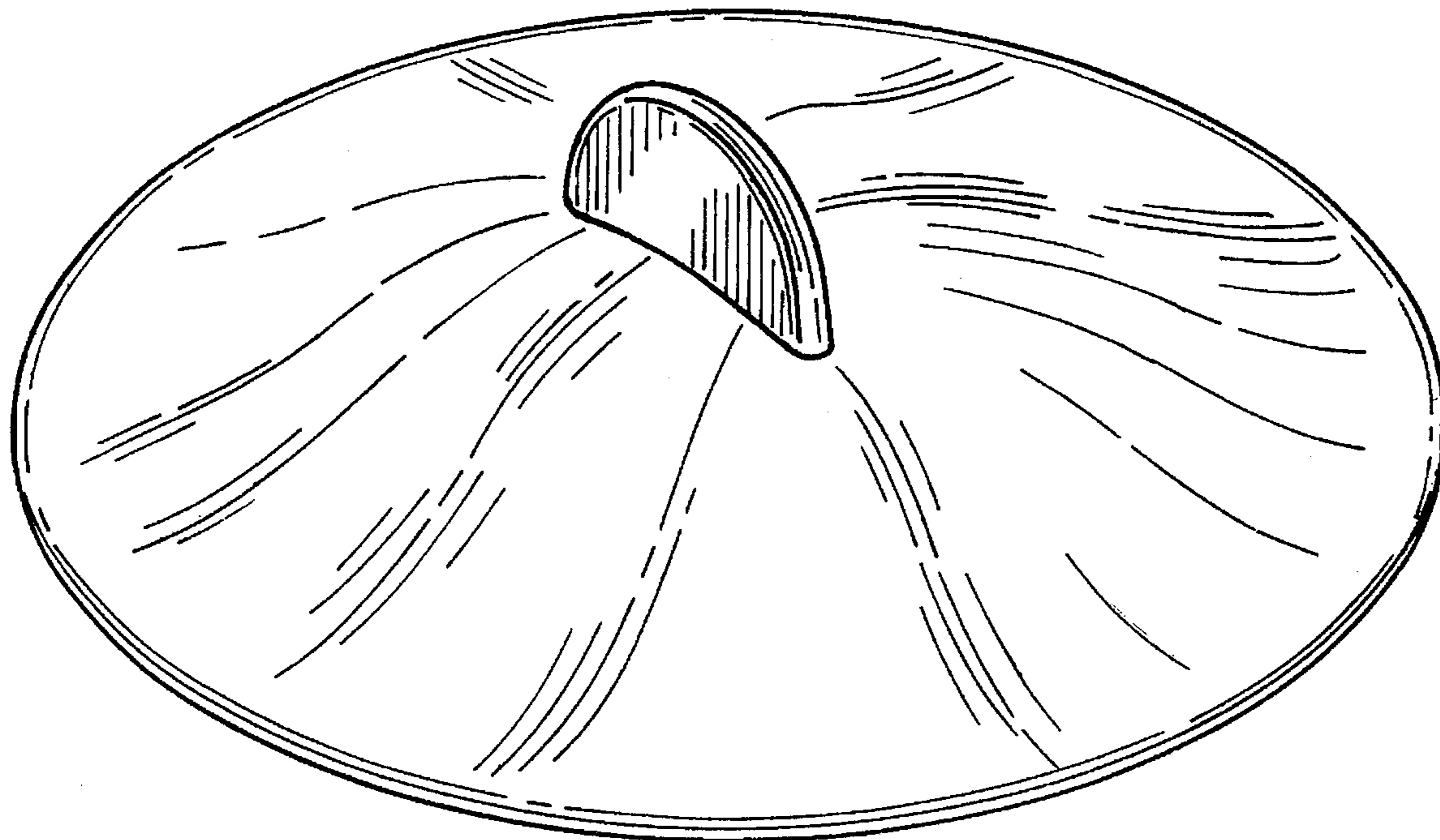

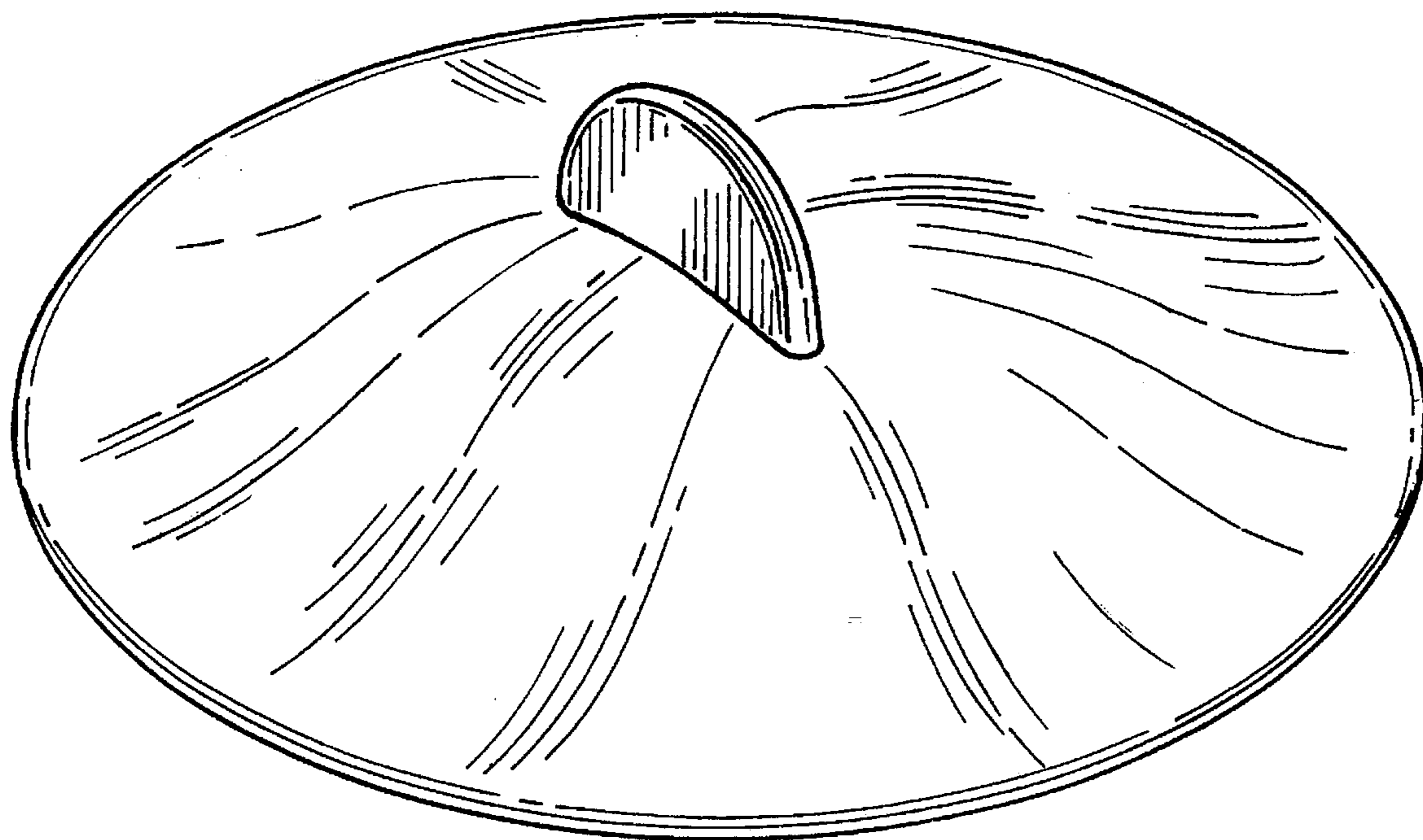

FIG. 1

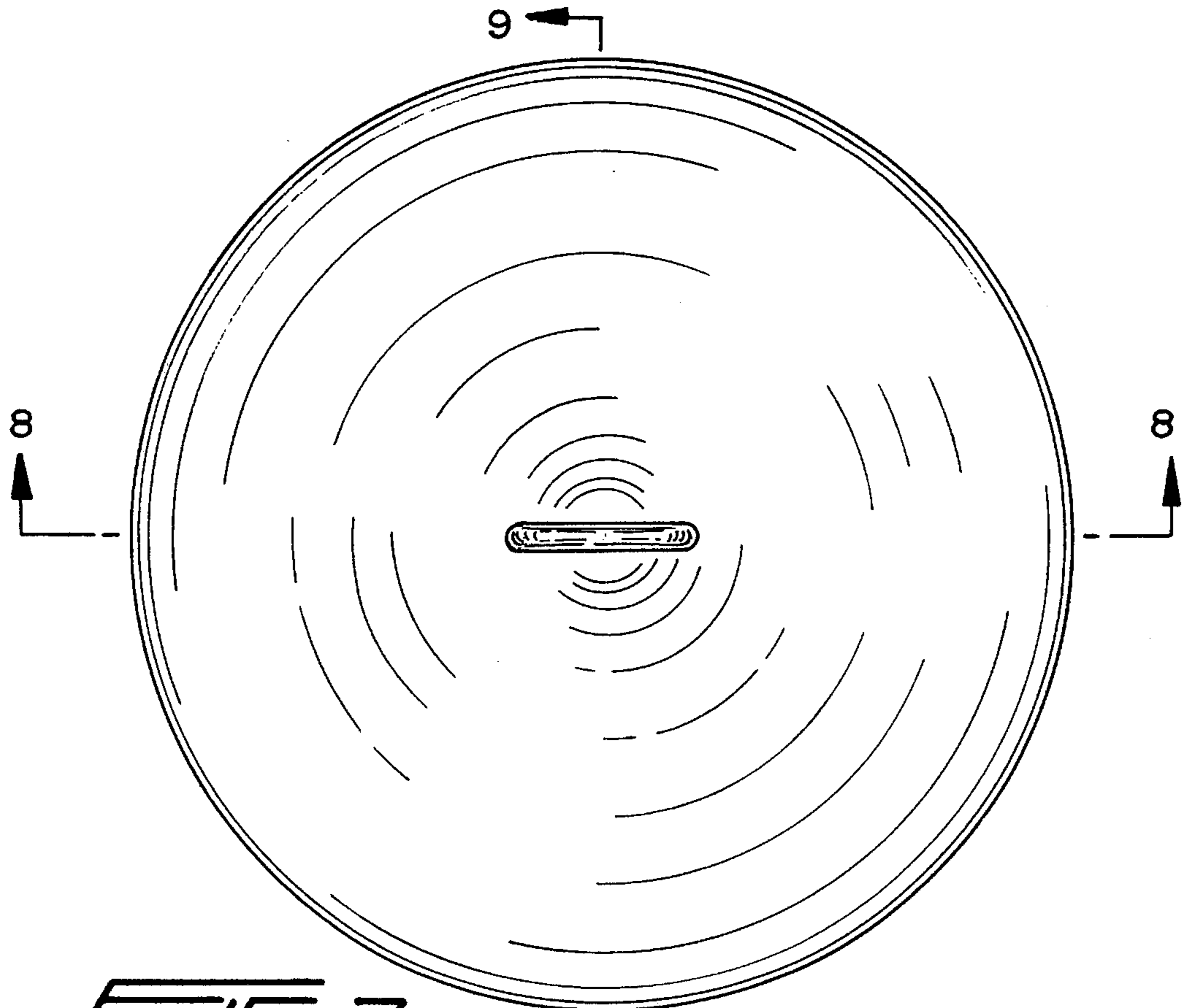

FIG. 2

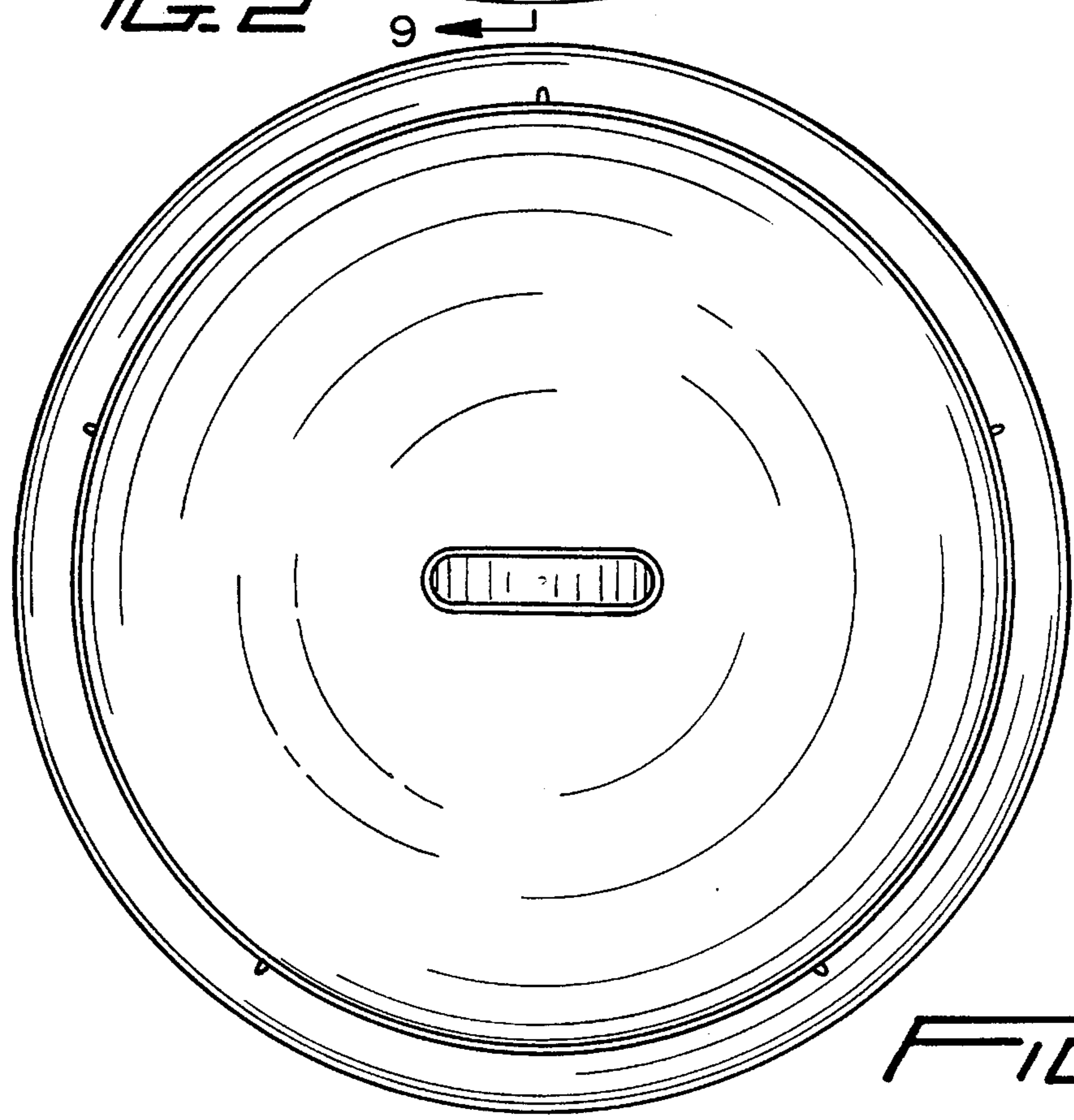

FIG. 3

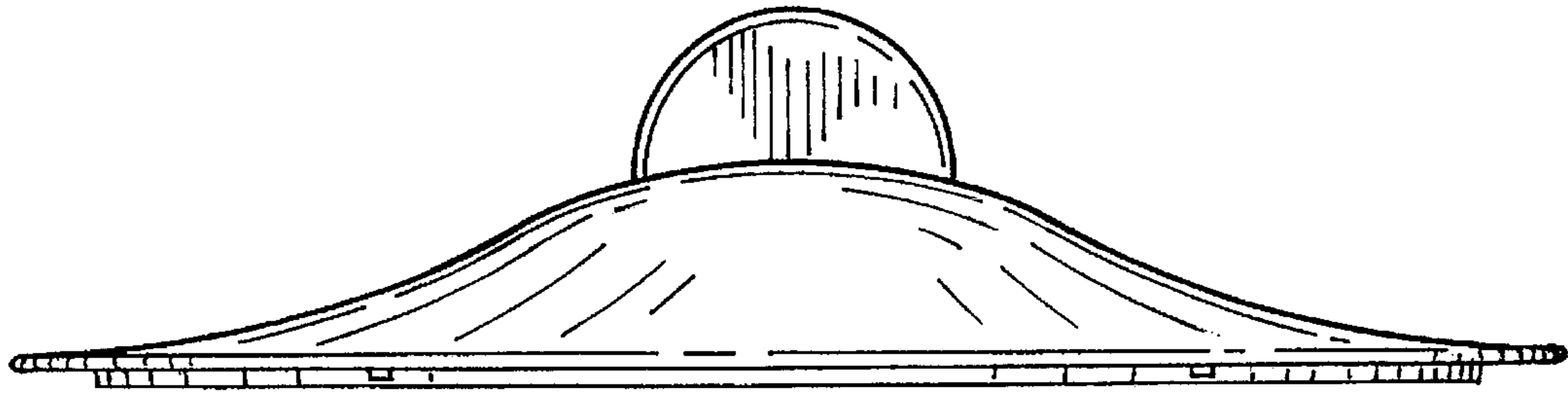

FIG. 4

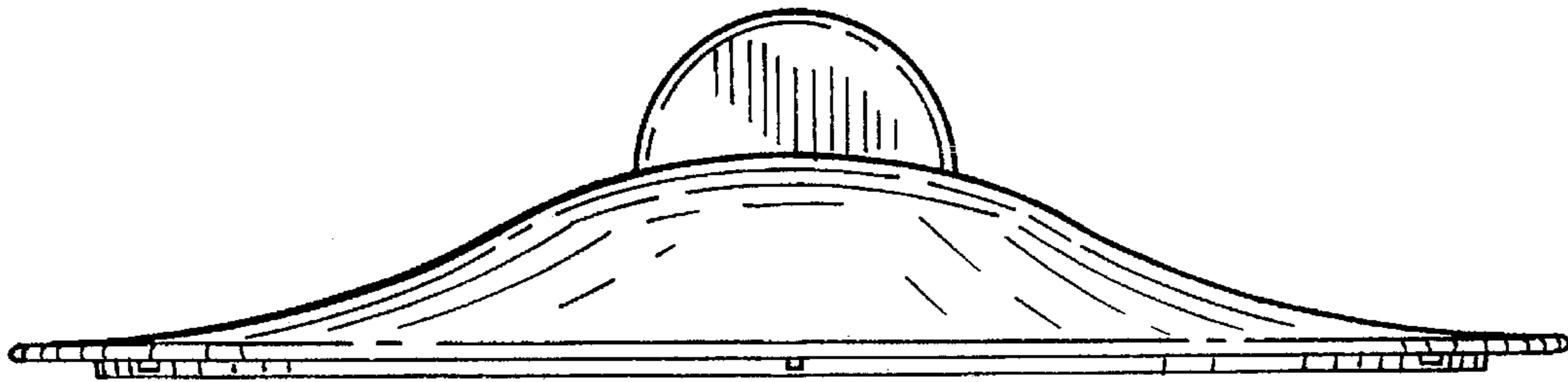

FIG. 5

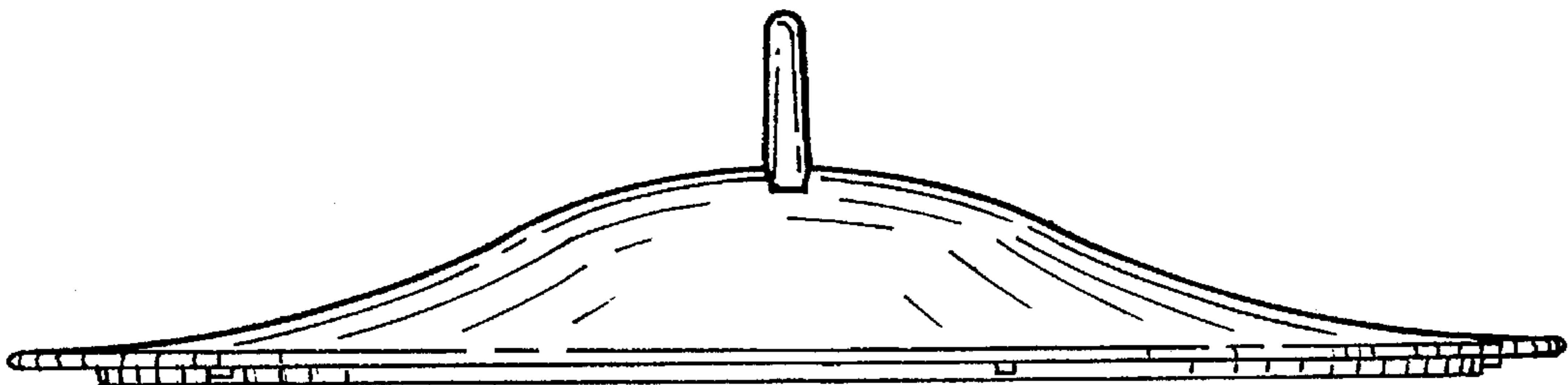

FIG. 6

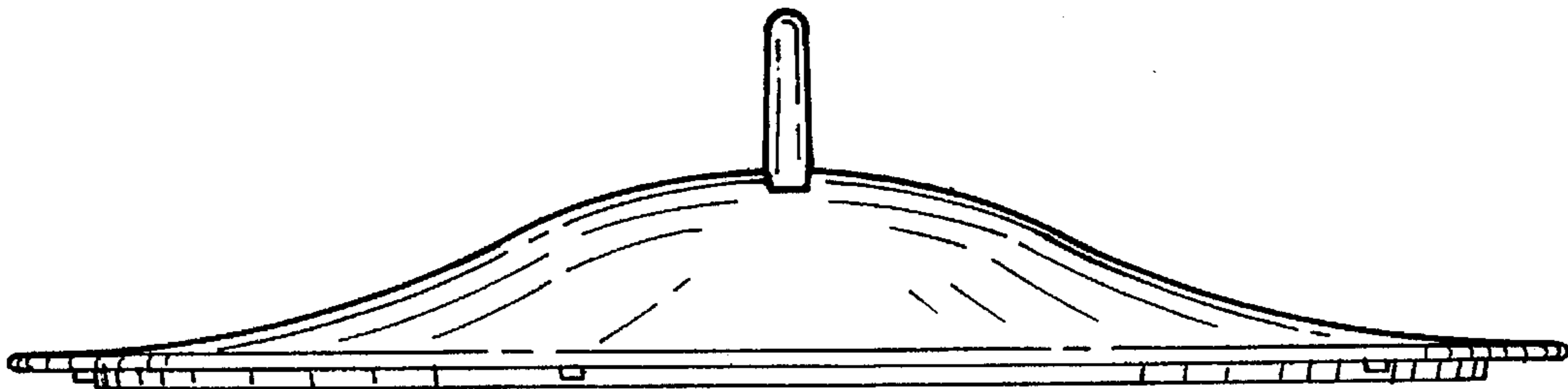

FIG. 7

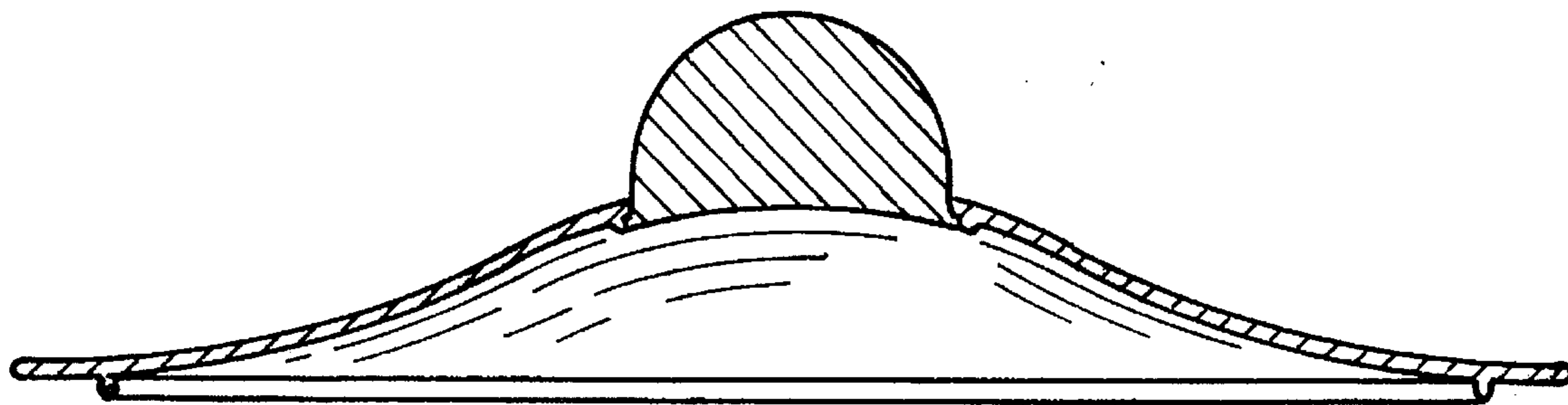

FIG. 8

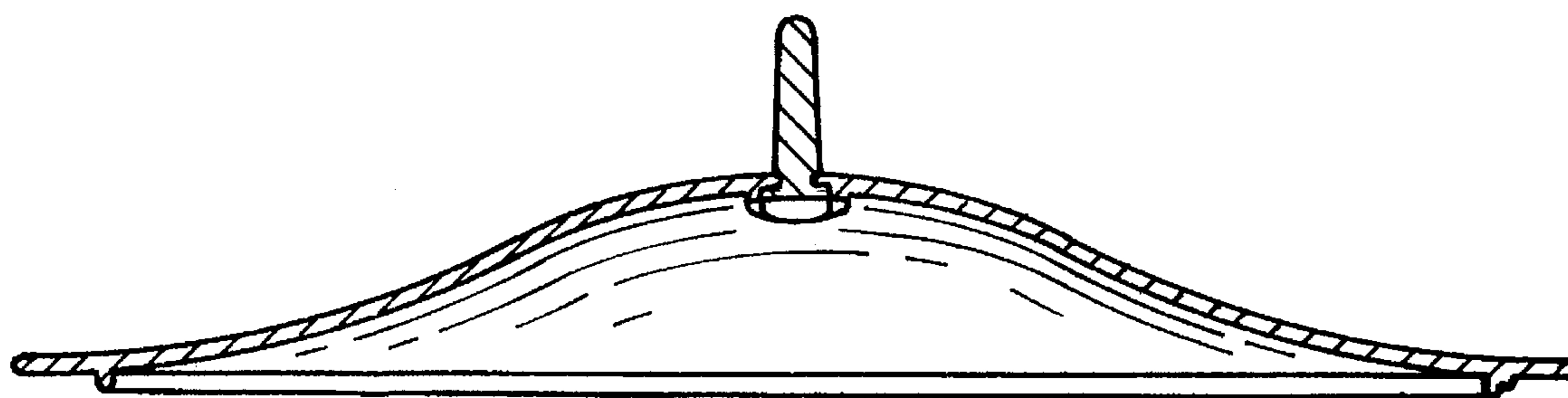

FIG. 9

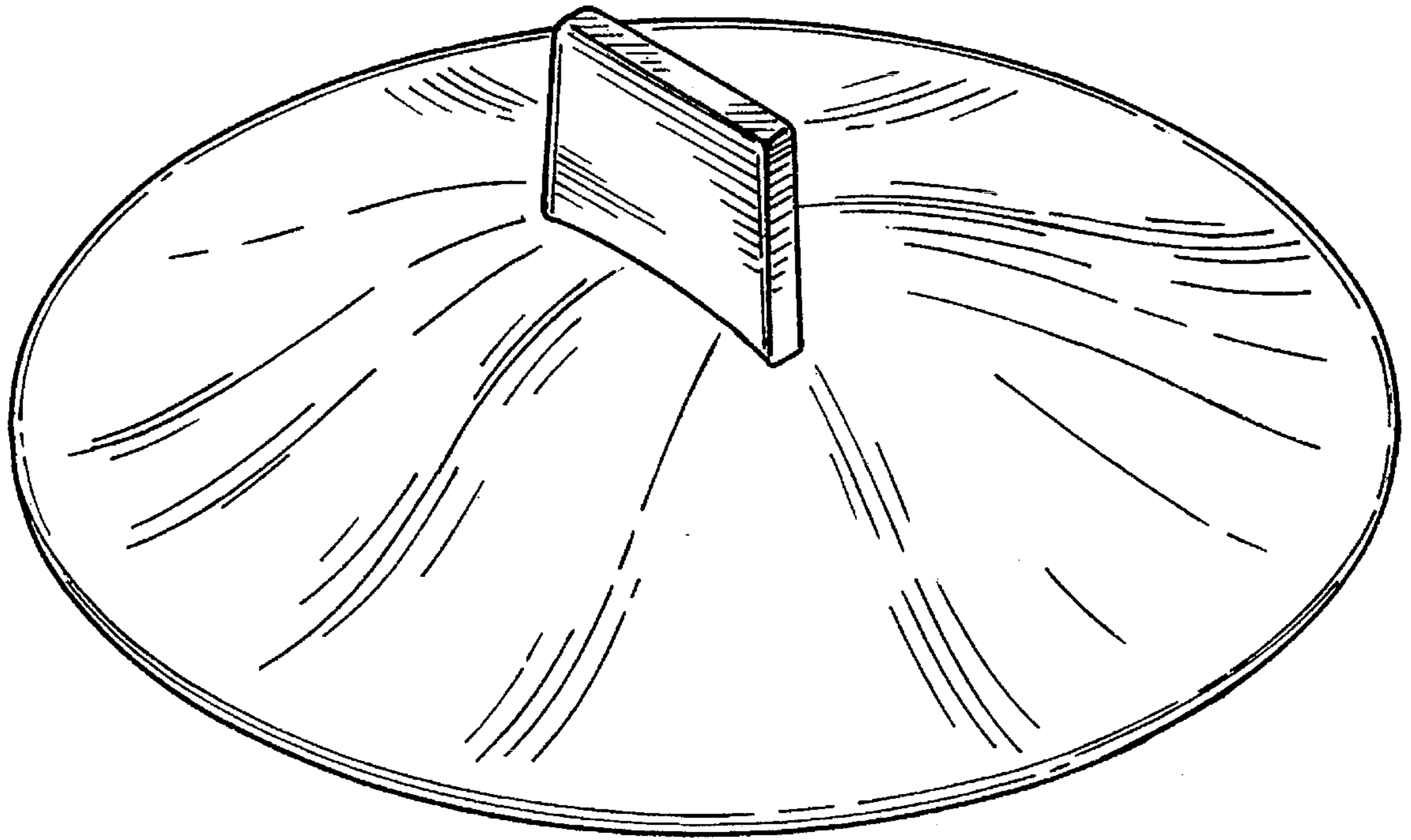

FIG. 10

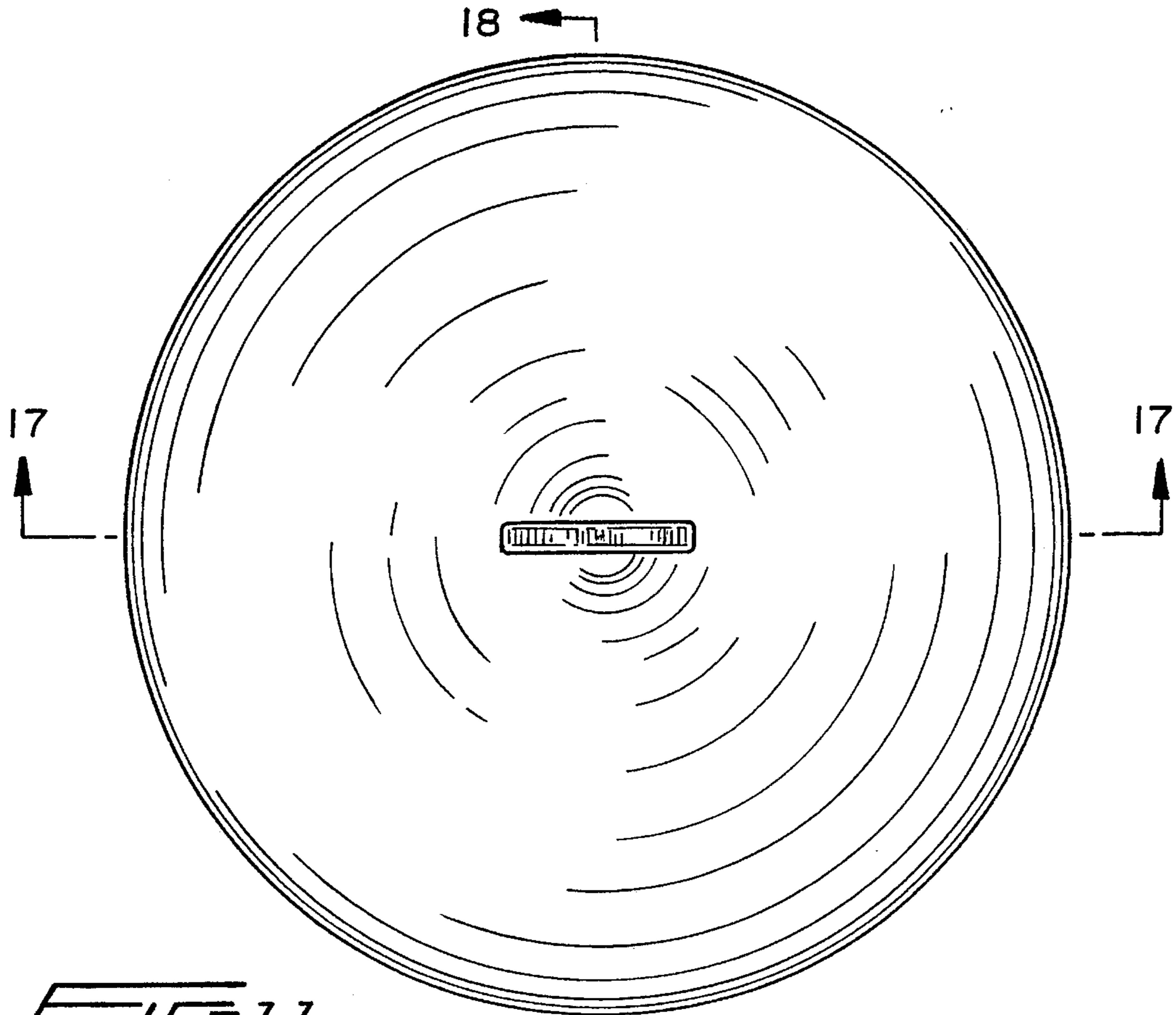

FIG. 11

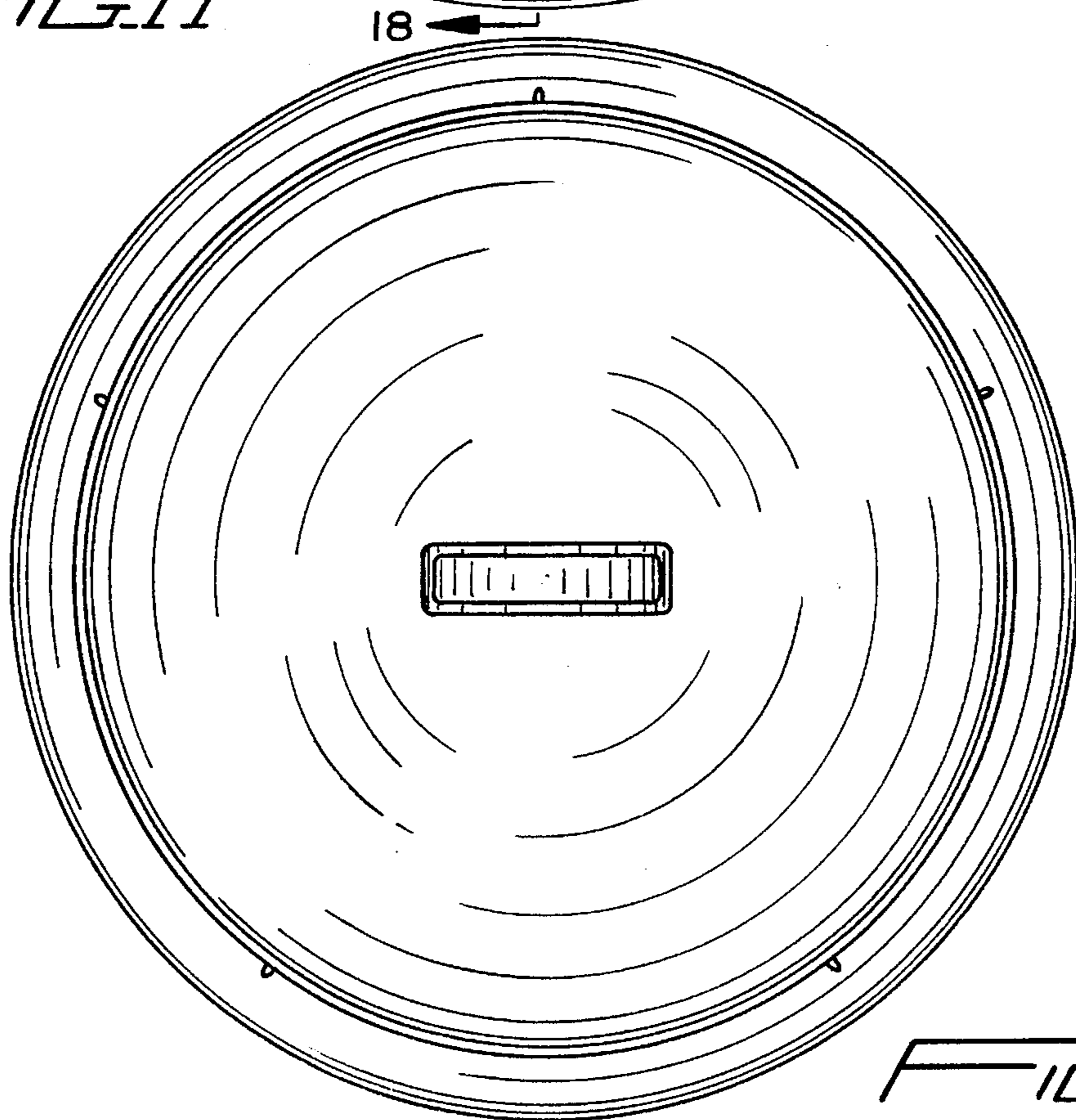

FIG. 12

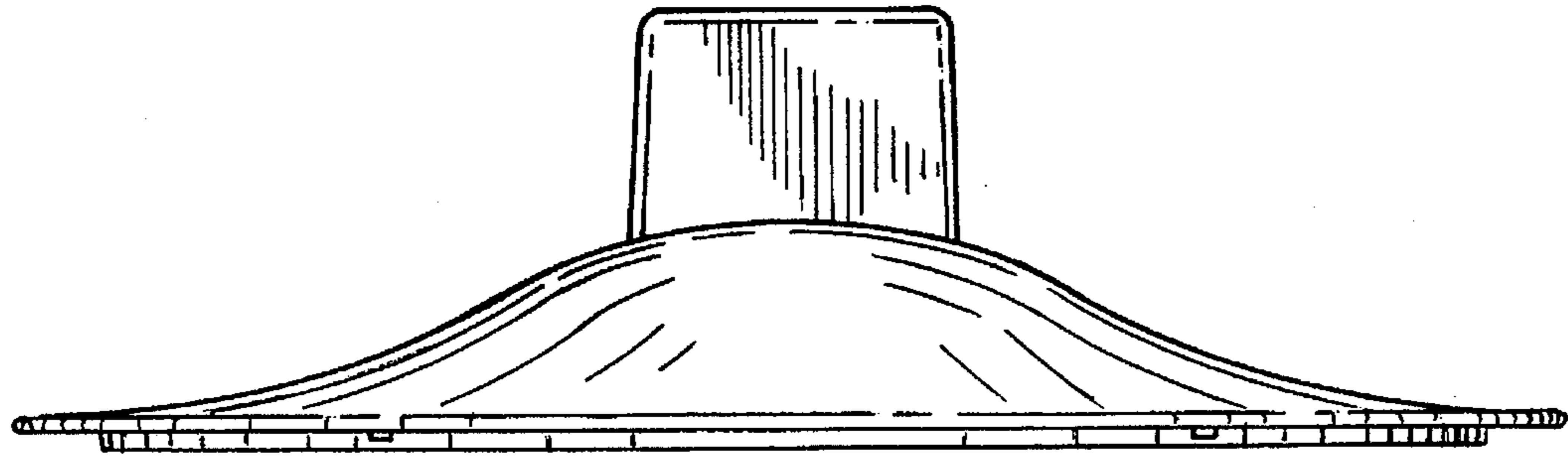

FIG. 13

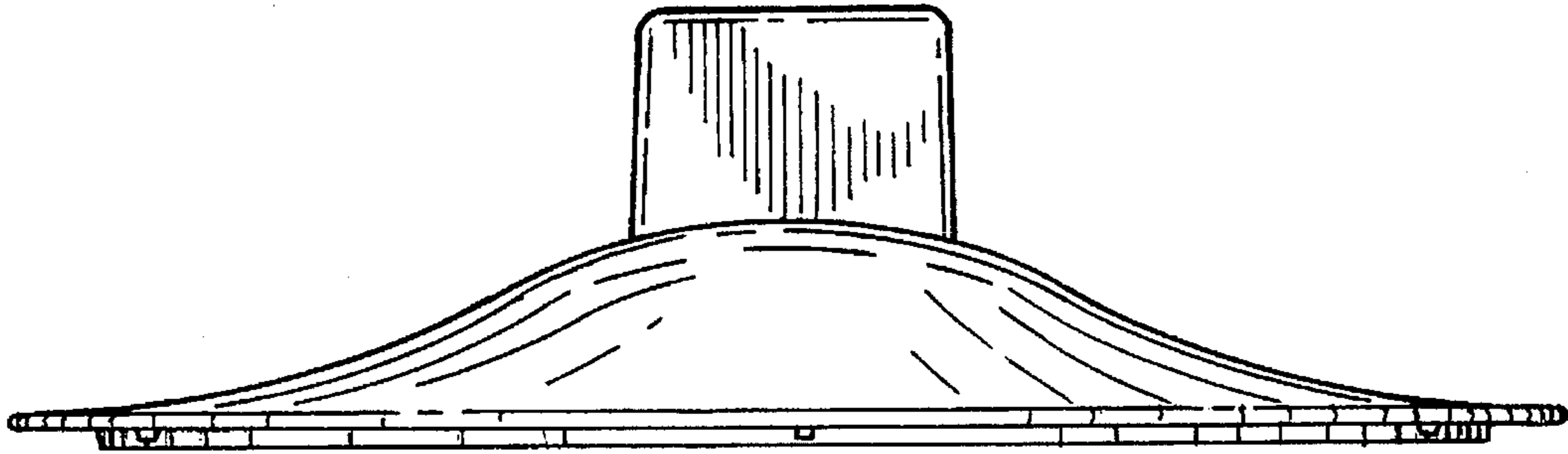

FIG. 14

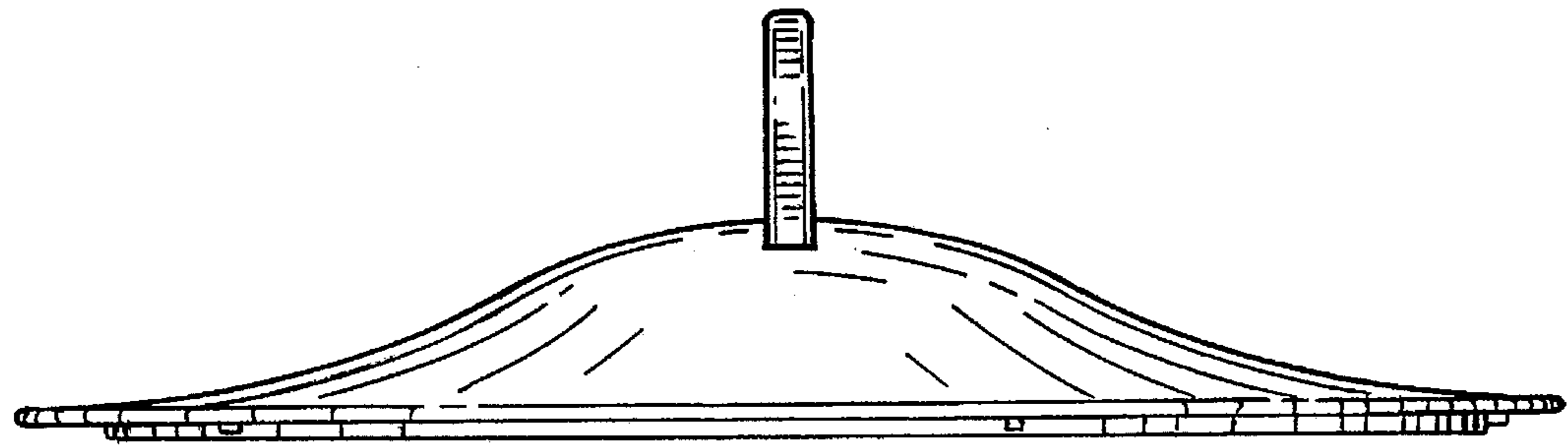

FIG. 15

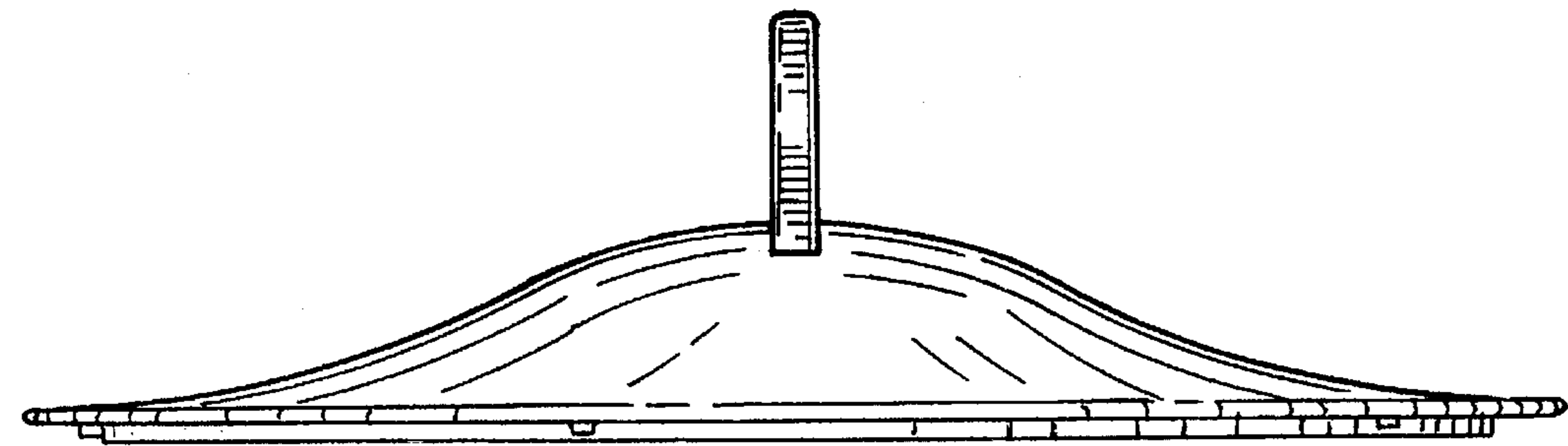

FIG. 16

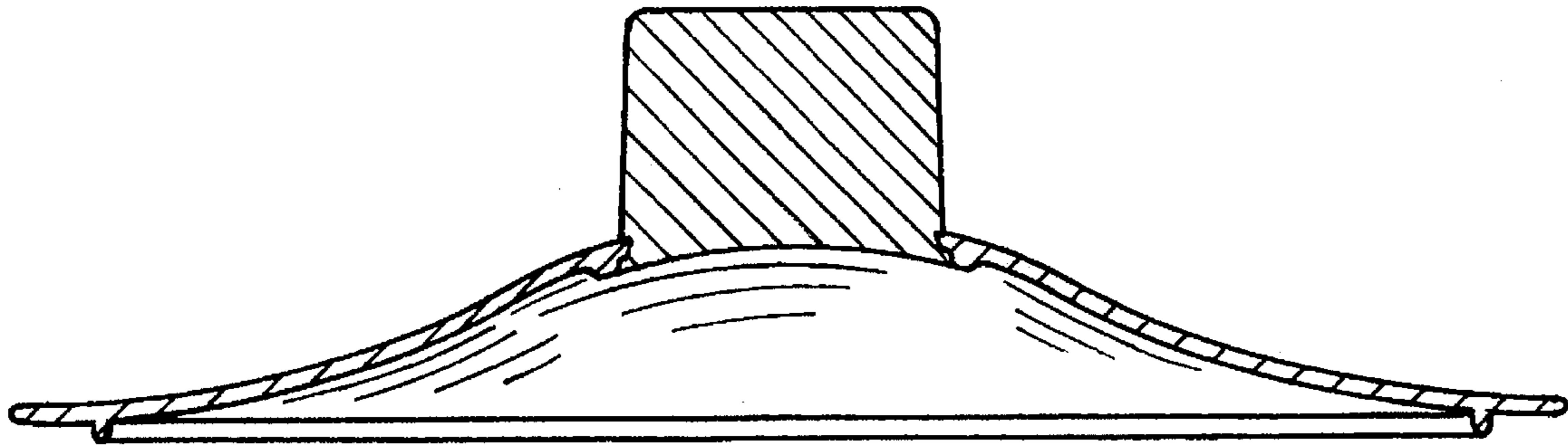

FIG. 17

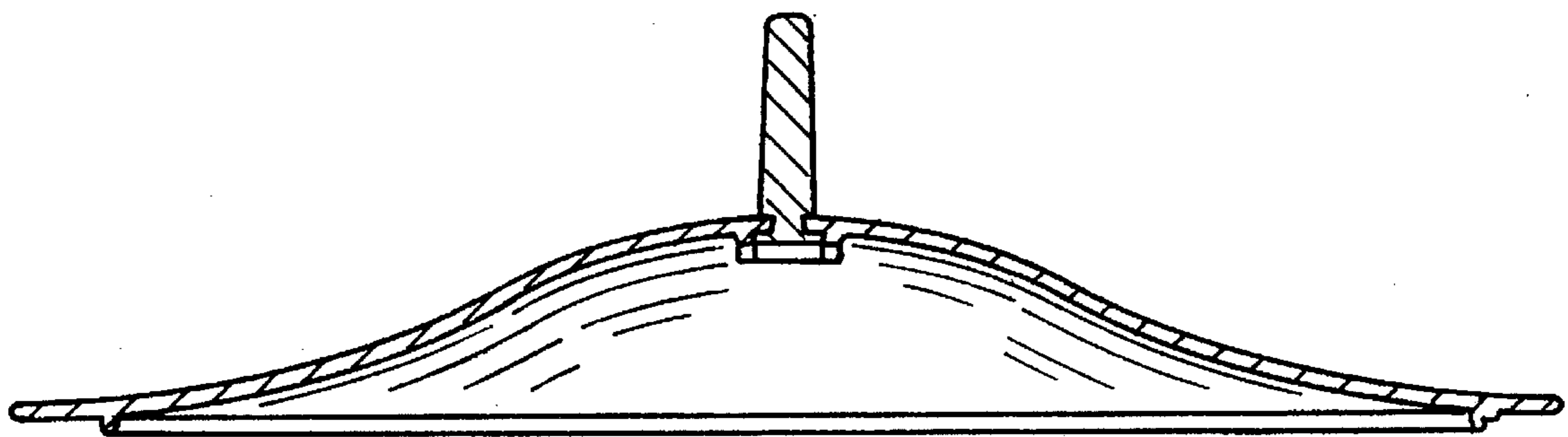

FIG. 18