



US00D375211S

United States Patent [19]

Mizzi

[11] Patent Number: **Des. 375,211**

[45] Date of Patent: ****Nov. 5, 1996**

[54] **MODULAR BEDROOM STORAGE UNIT**

[76] Inventor: **Joseph A. Mizzi**, 18992 Florida St., Apt. B-10, Huntington Beach, Calif. 92648

[**] Term: **14 Years**

[21] Appl. No.: **37,186**

[22] Filed: **Apr. 6, 1995**

[52] U.S. Cl. **D6/397; D6/384**

[58] Field of Search **D6/396, 397, 432-448, D6/384, 422-428, 477-479; 5/2.1; 312/204**

3,950,796	4/1976	Hollingsworth .
4,109,328	8/1978	Mason .
5,003,650	4/1991	Caya .
5,233,707	8/1993	Perkins .

FOREIGN PATENT DOCUMENTS

565533	8/1975	Denmark .
1163476	9/1969	United Kingdom .

Primary Examiner—Carmen H. Vales-Lado
Attorney, Agent, or Firm—Dennis H. Lambert

[57] CLAIM

The ornamental design for a modular bedroom storage unit, as shown and described.

References Cited

U.S. PATENT DOCUMENTS

D. 246,018	10/1977	Hero et al.	D6/384
D. 283,184	4/1986	Saporiti	D6/436
D. 312,641	12/1990	Morales et al.	D6/397 X
D. 314,090	1/1991	Stephens et al.	D6/397
D. 321,099	10/1991	Fullhart	D6/384
D. 335,974	6/1993	Thomas	D6/399
D. 336,572	6/1993	Gunderson et al.	D6/399
D. 356,220	3/1995	Belisle	D6/446
D. 358,269	5/1995	Korch et al.	D6/397
D. 365,698	1/1996	Pauer et al.	D6/397
3,325,233	6/1967	Oppenhuizen et al. .	
3,596,297	8/1971	James .	

DESCRIPTION

FIG. 1 is a front, top and side perspective view of the modular bedroom storage unit embodying the design of the present invention;
FIG. 2 is a right side elevational view of FIG. 1;
FIG. 3 is a left side elevational view thereof;
FIG. 4 is a front elevational view thereof;
FIG. 5 is a rear elevational view thereof;
FIG. 6 is a top plan view thereof; and,
FIG. 7 is a bottom plan view thereof.

1 Claim, 3 Drawing Sheets

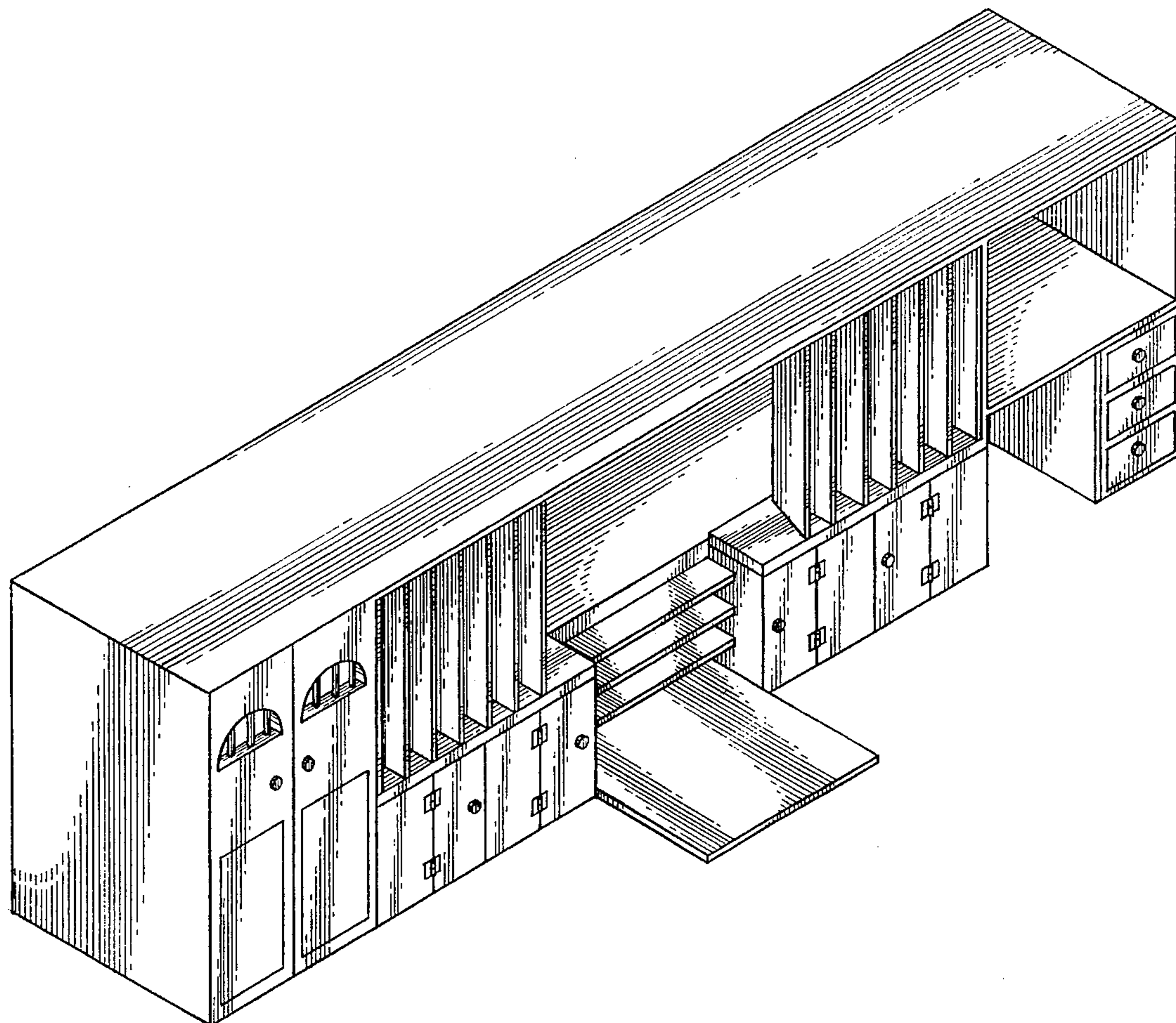

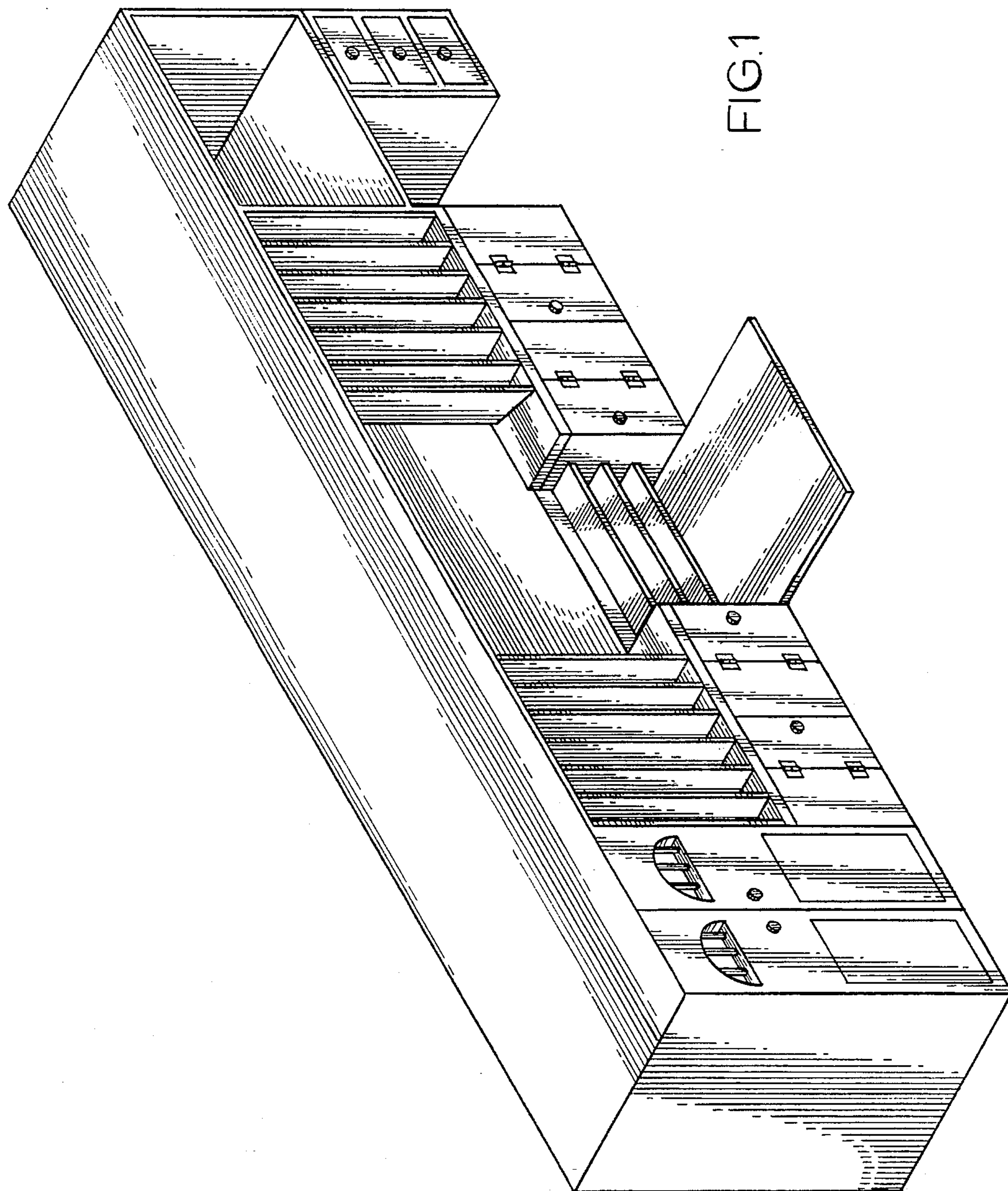

FIG.1

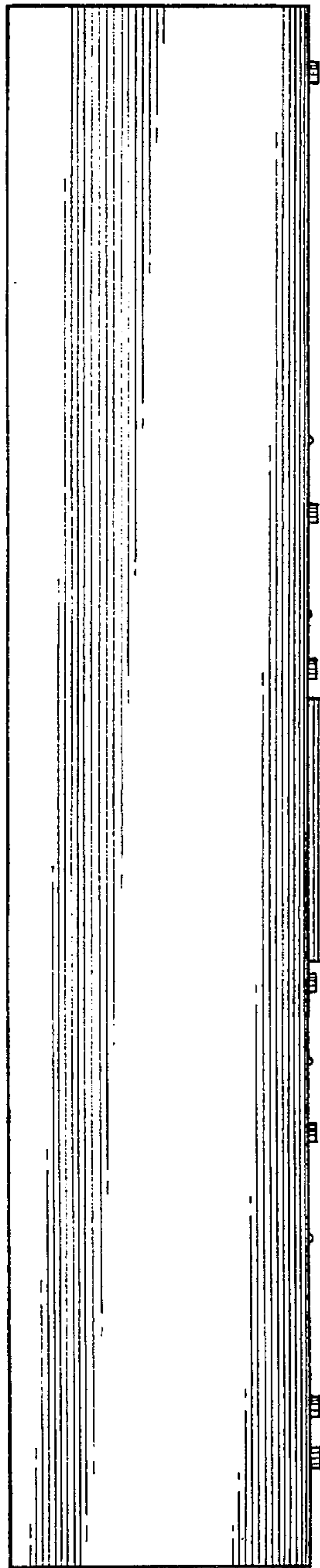

FIG. 6

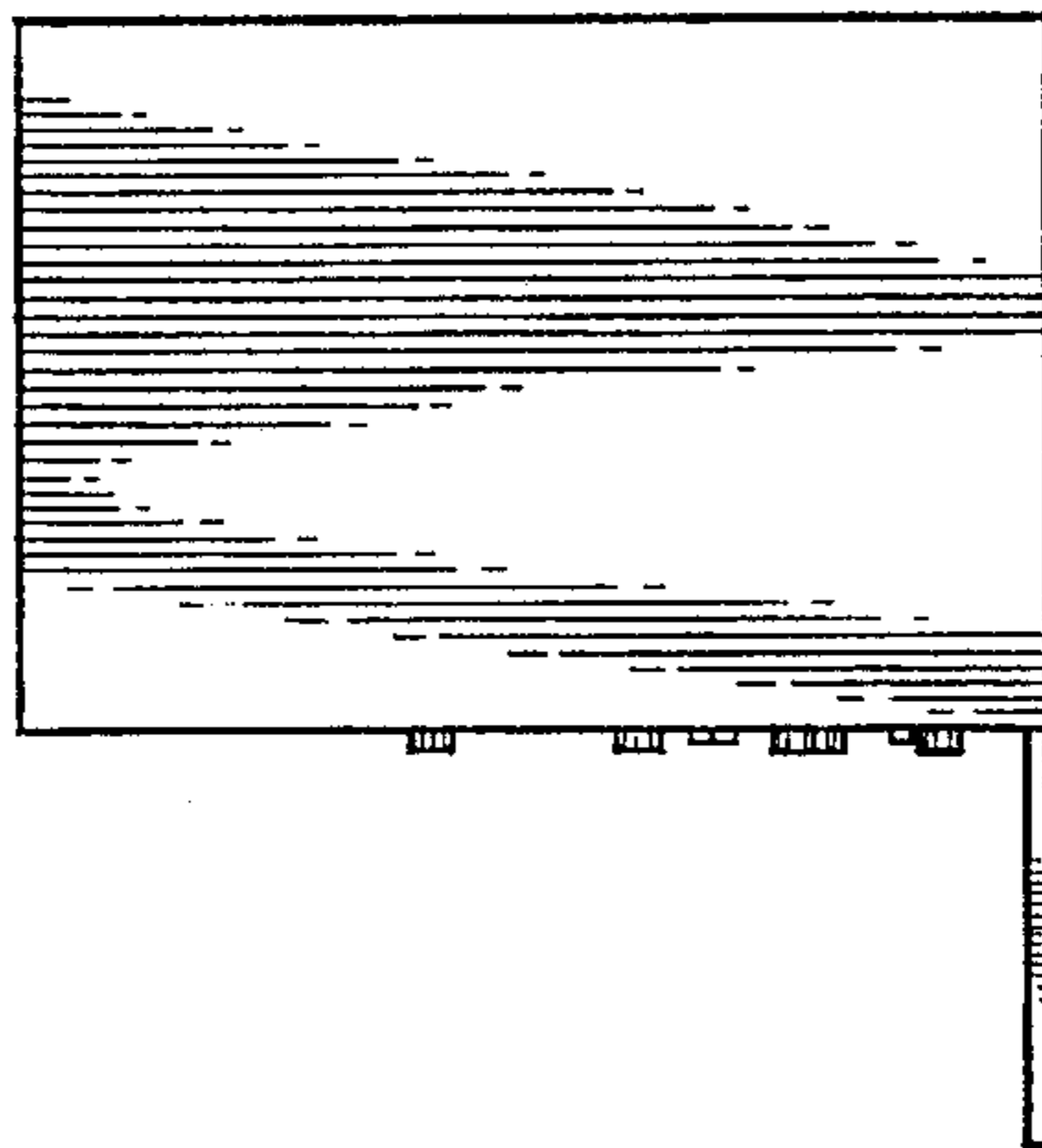

FIG. 2

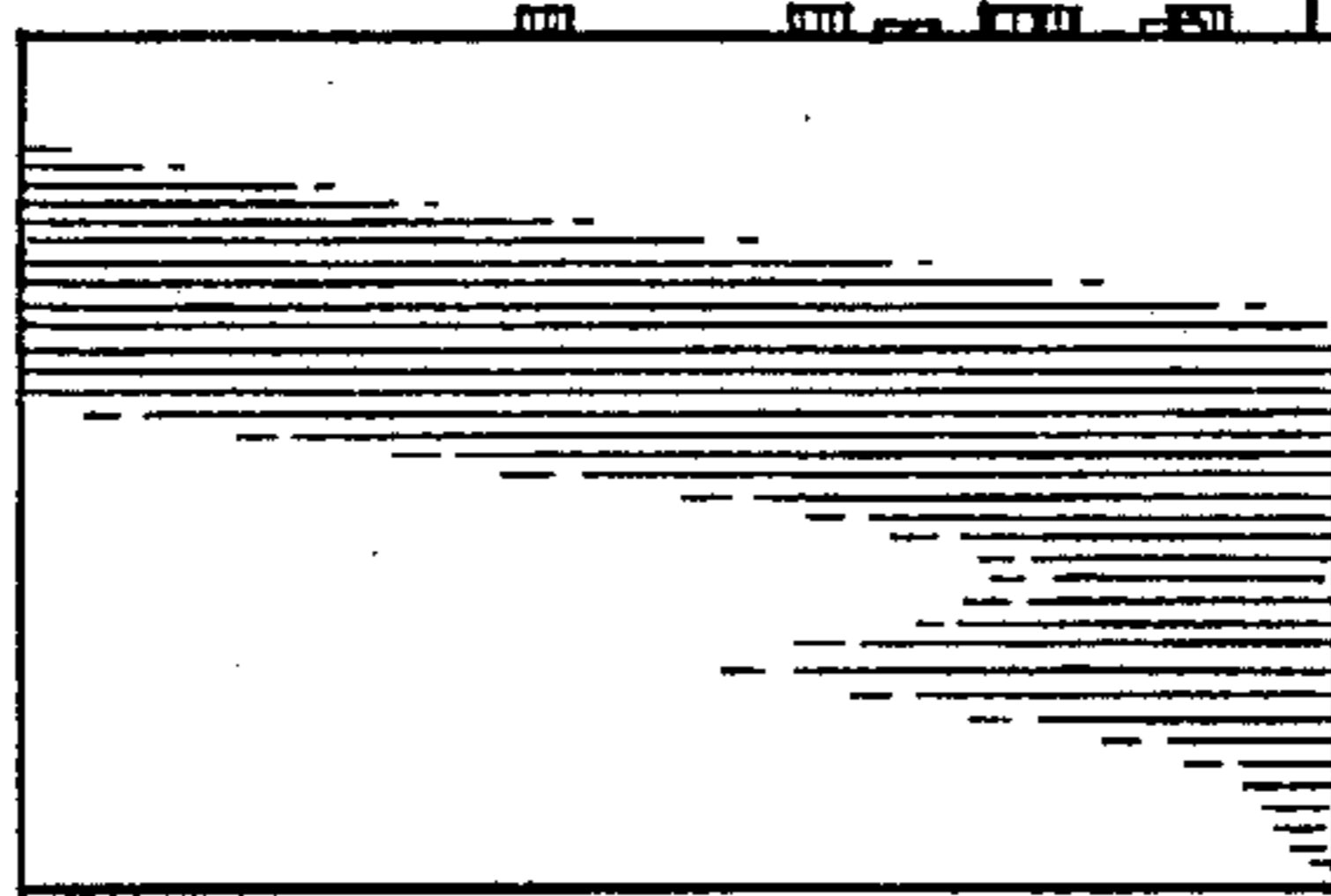

FIG. 3

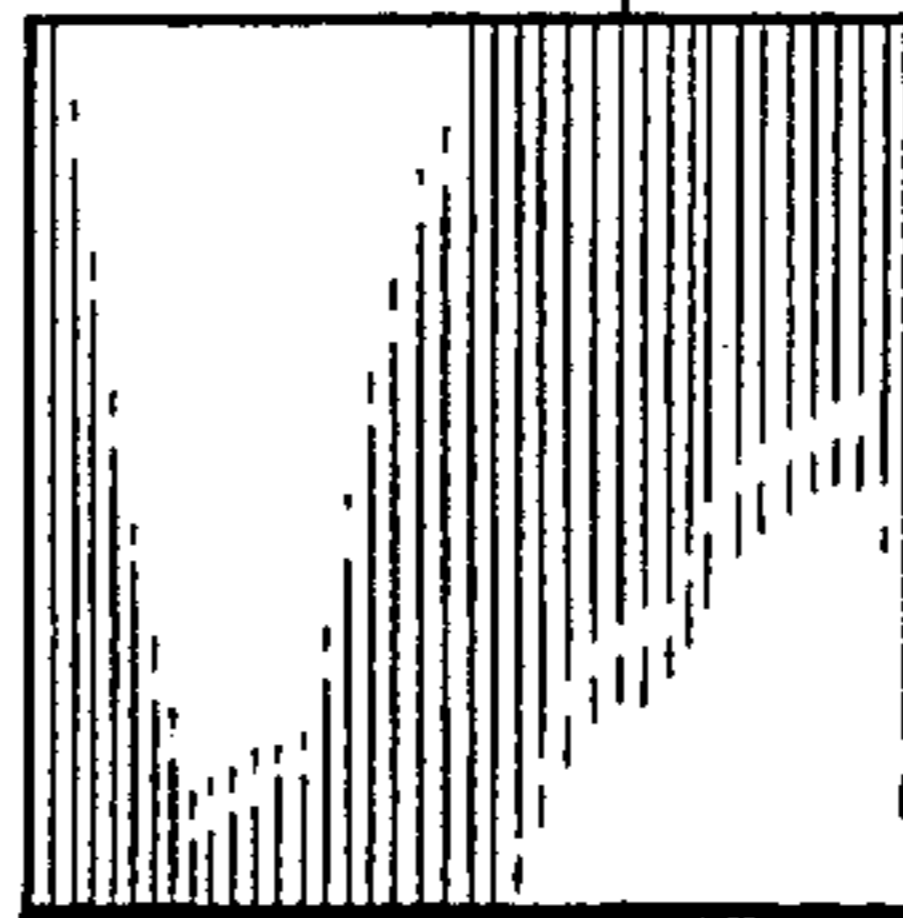
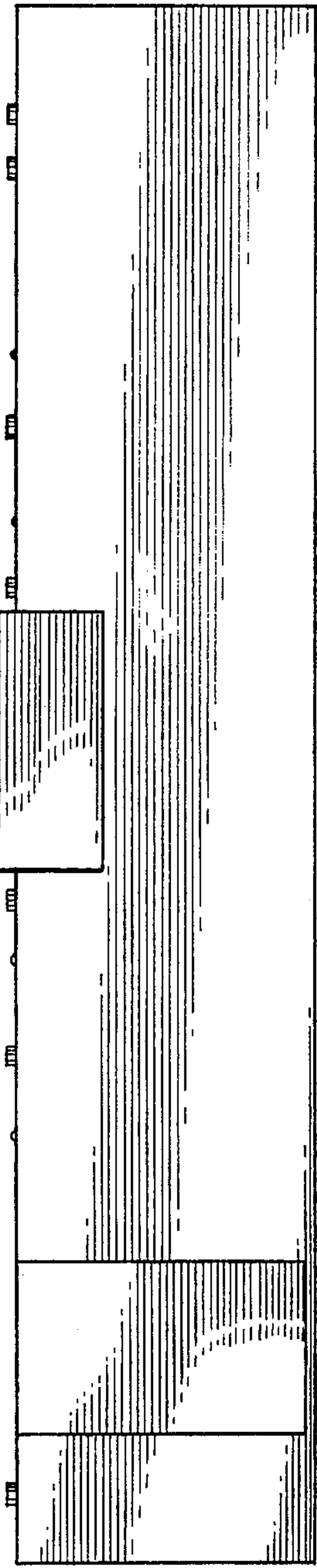

FIG. 7



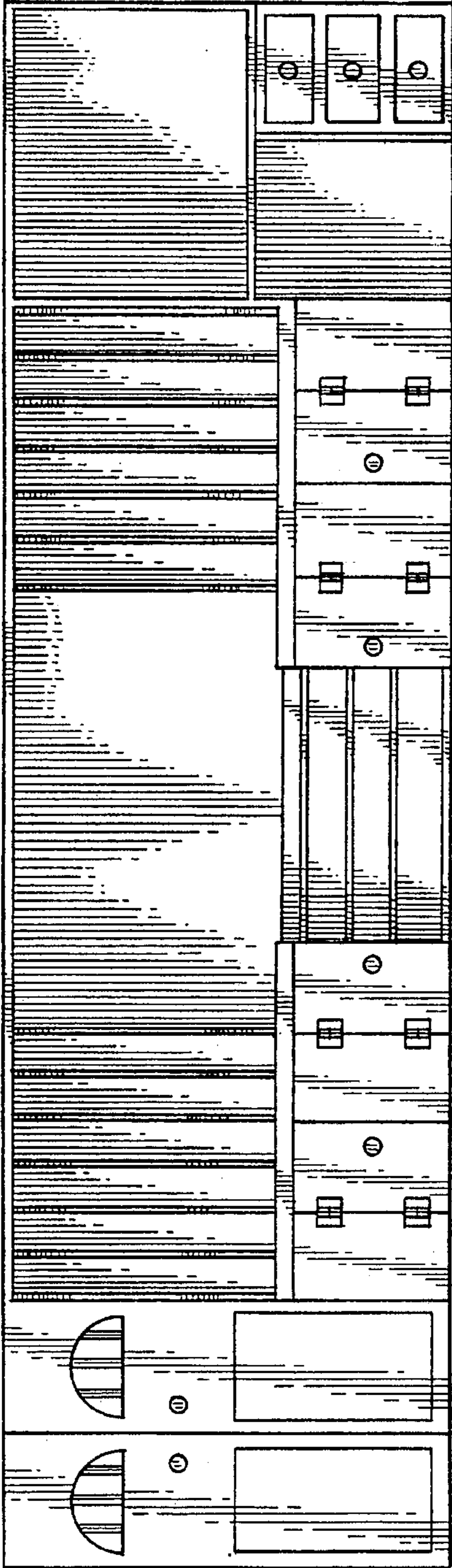

FIG. 4

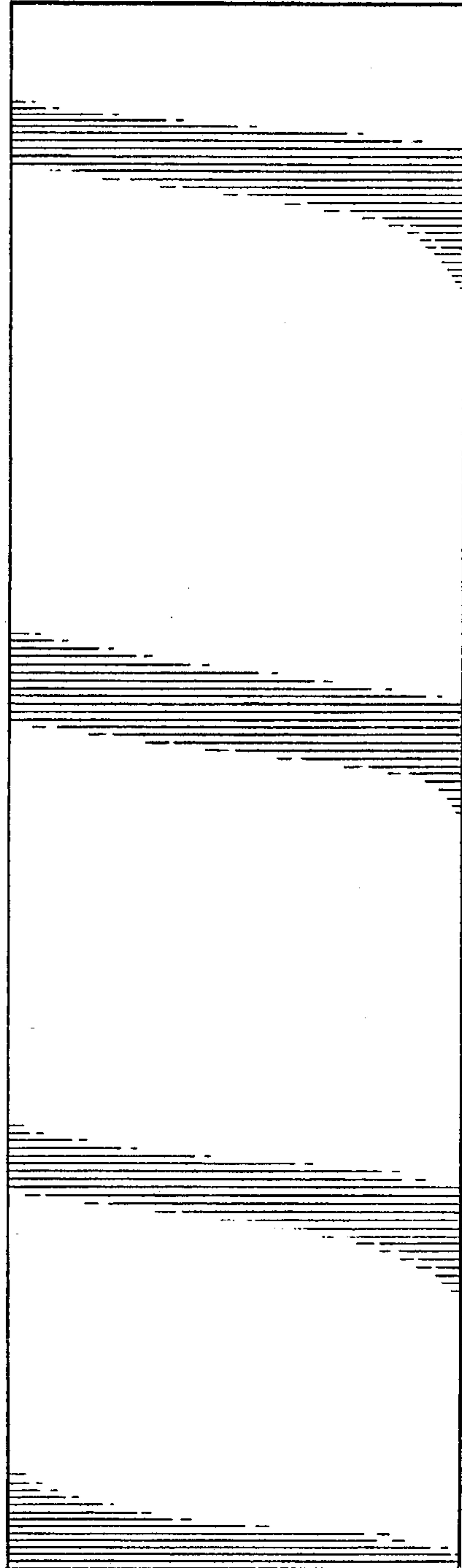

FIG. 5