



US00D375152S

United States Patent [19]

[11] Patent Number: **Des. 375,152**

Jacuzzi

[45] Date of Patent: ****Oct. 29, 1996**

[54] BATH TUB

[75] Inventor: **Remo Jacuzzi**, Little Rock, Ark.

[73] Assignee: **Jason International, Inc.**, North Little Rock, Ark.

[**] Term: **14 Years**

[21] Appl. No.: **37,875**

[22] Filed: **Apr. 21, 1995**

[52] U.S. Cl. **D23/277**

[58] Field of Search D23/277, 280.1-280.4;
D24/201, 202, 204, 205; 4/538, 541.1-541.6

[56] **References Cited**

U.S. PATENT DOCUMENTS

D. 216,119	11/1969	Kaiser	
D. 219,824	2/1971	Goodoll	D23/280.1
D. 318,521	7/1991	Zarinfar	D23/280.1
D. 354,115	1/1995	McKeone	D23/277
D. 362,050	9/1995	Jacuzzi	D23/277

OTHER PUBLICATIONS

"The First Family of Luxury Bathing," Brochure, Jason International, Inc., N. Little Rock, AR, (admitted prior art). Jason Luxury Bathing Systems, "Ahhh . . . the luxury of Jason™," Pamphlet, Jason International, Inc. N. Little Rock, AR, (admitted prior art).

Jason® Whirlpool Products, "Technical Data Designer Series Whirlpool Bath Products", Sales Data Sheet SJI-005-190, Jason International, Inc., N. Little Rock, AR, Jan. 1, 1990.

Primary Examiner—Stella Reid
Assistant Examiner—Eric Watterson
Attorney, Agent, or Firm—Banner & Allegretti

[57] **CLAIM**

The ornamental design for a bath tub, as shown and described.

DESCRIPTION

FIG. 1 is a top perspective view of a bath tub showing my new design;
FIG. 2 is a top plan view thereof;
FIG. 3 is a bottom plan view thereof;
FIG. 4 is a right end elevational view thereof;
FIG. 5 is a left end elevational view thereof;
FIG. 6 is a cross-sectional view taken along line 6-6 of FIG. 2;
FIG. 7 is a right side elevational view of the bath tub shown in FIG. 1, the left side being a mirror image thereof; and, FIG. 8 is a cross-sectional view taken along line 8-8 of FIG. 2.

1 Claim, 4 Drawing Sheets

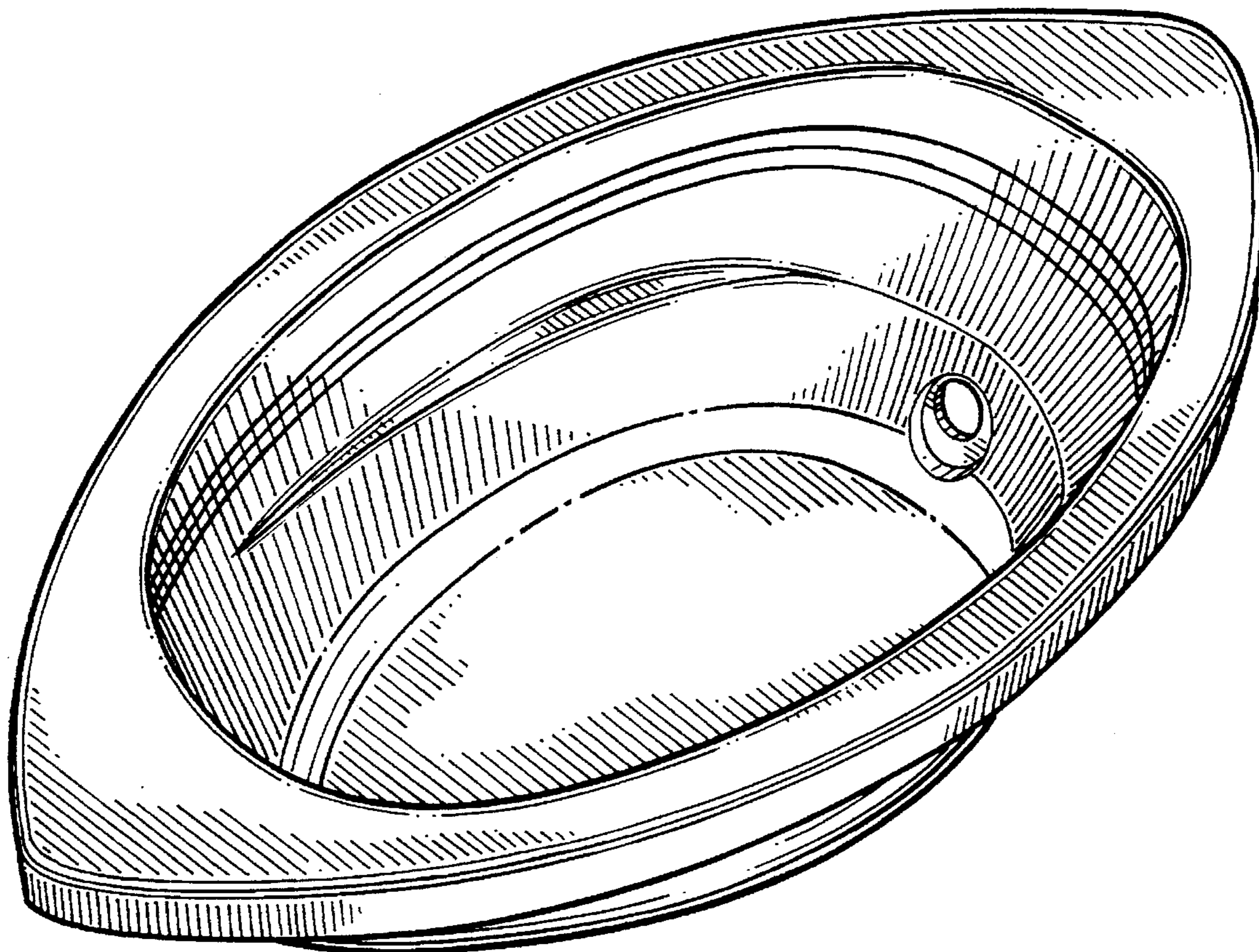

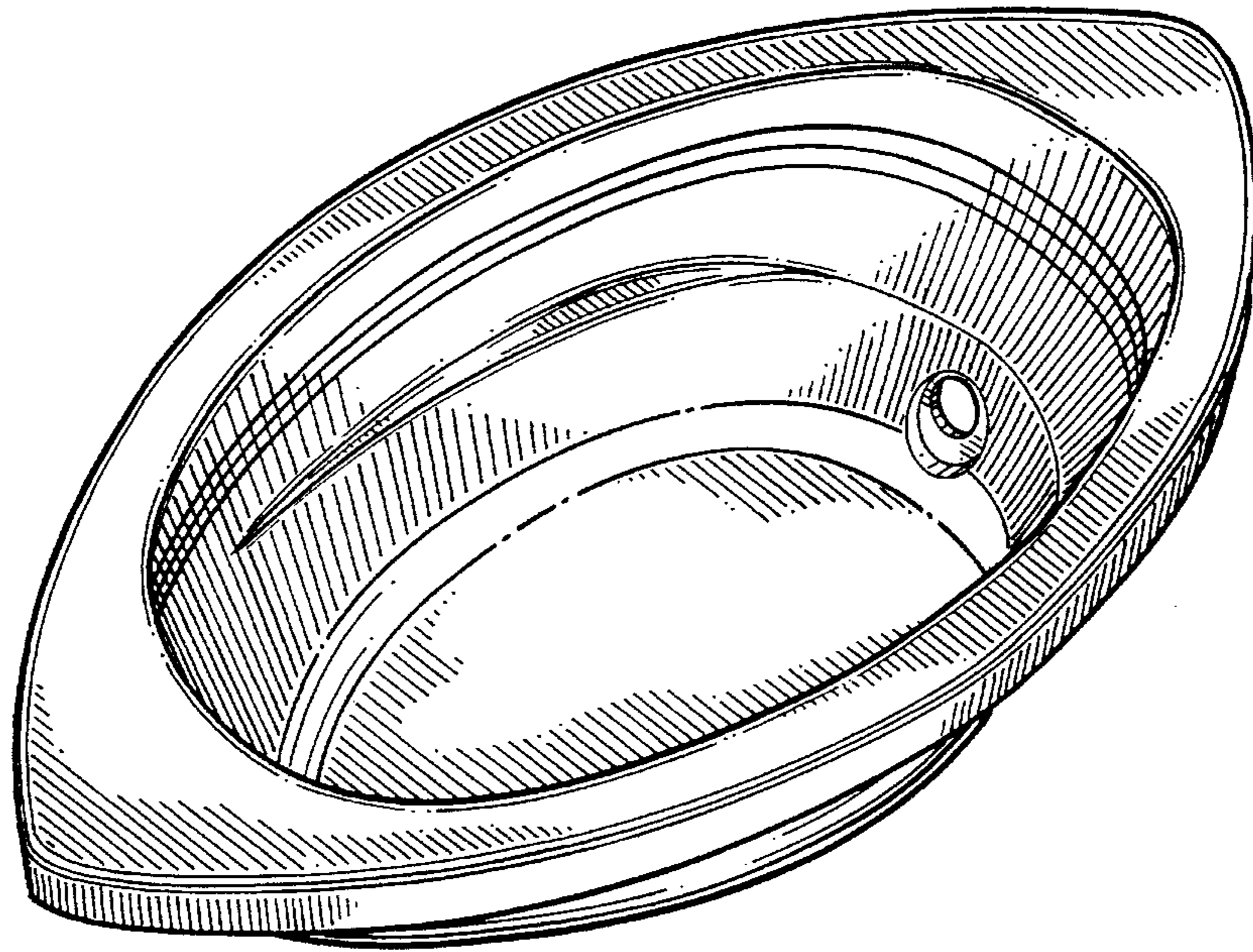

FIG. 1

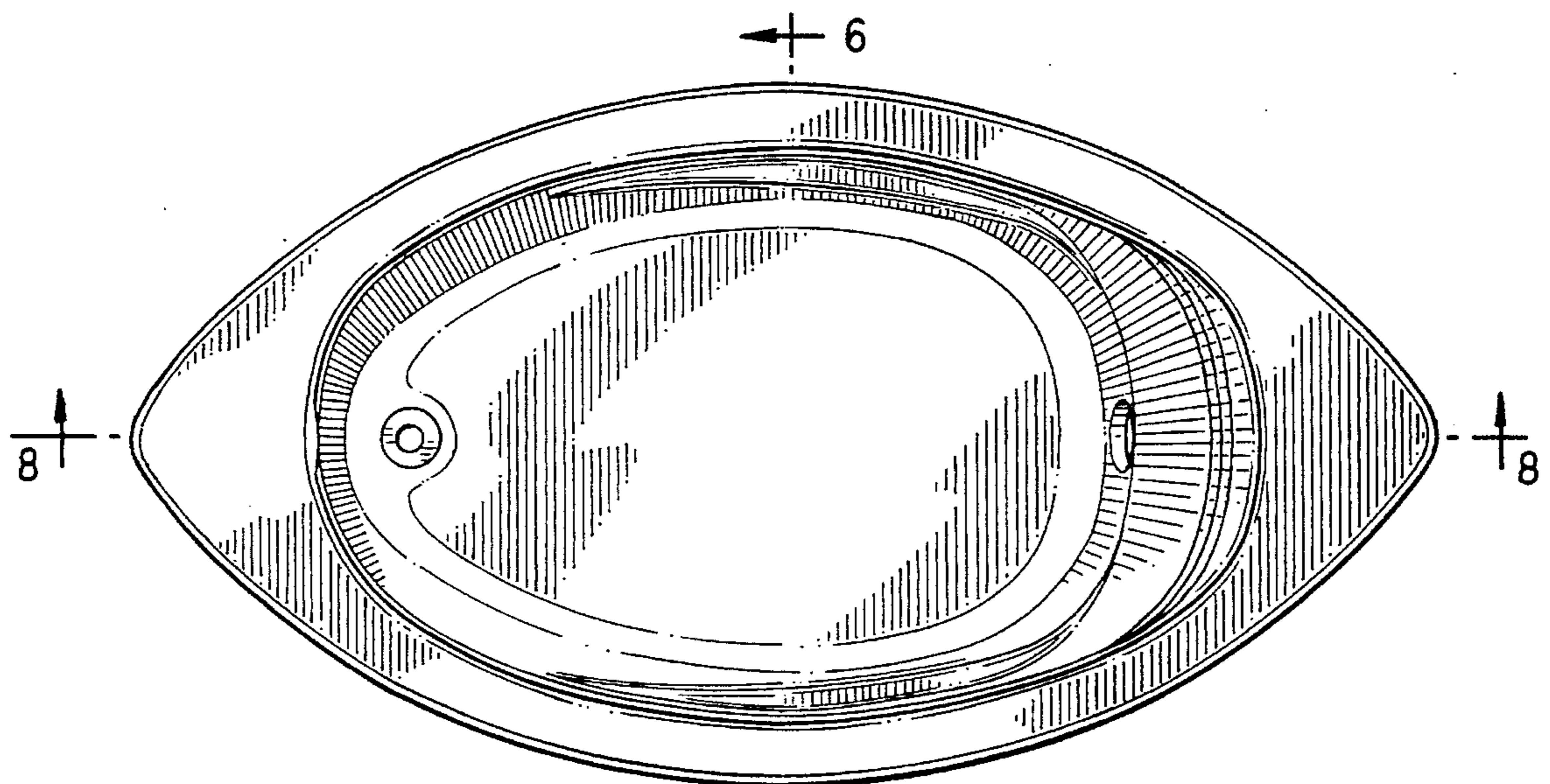

FIG. 2

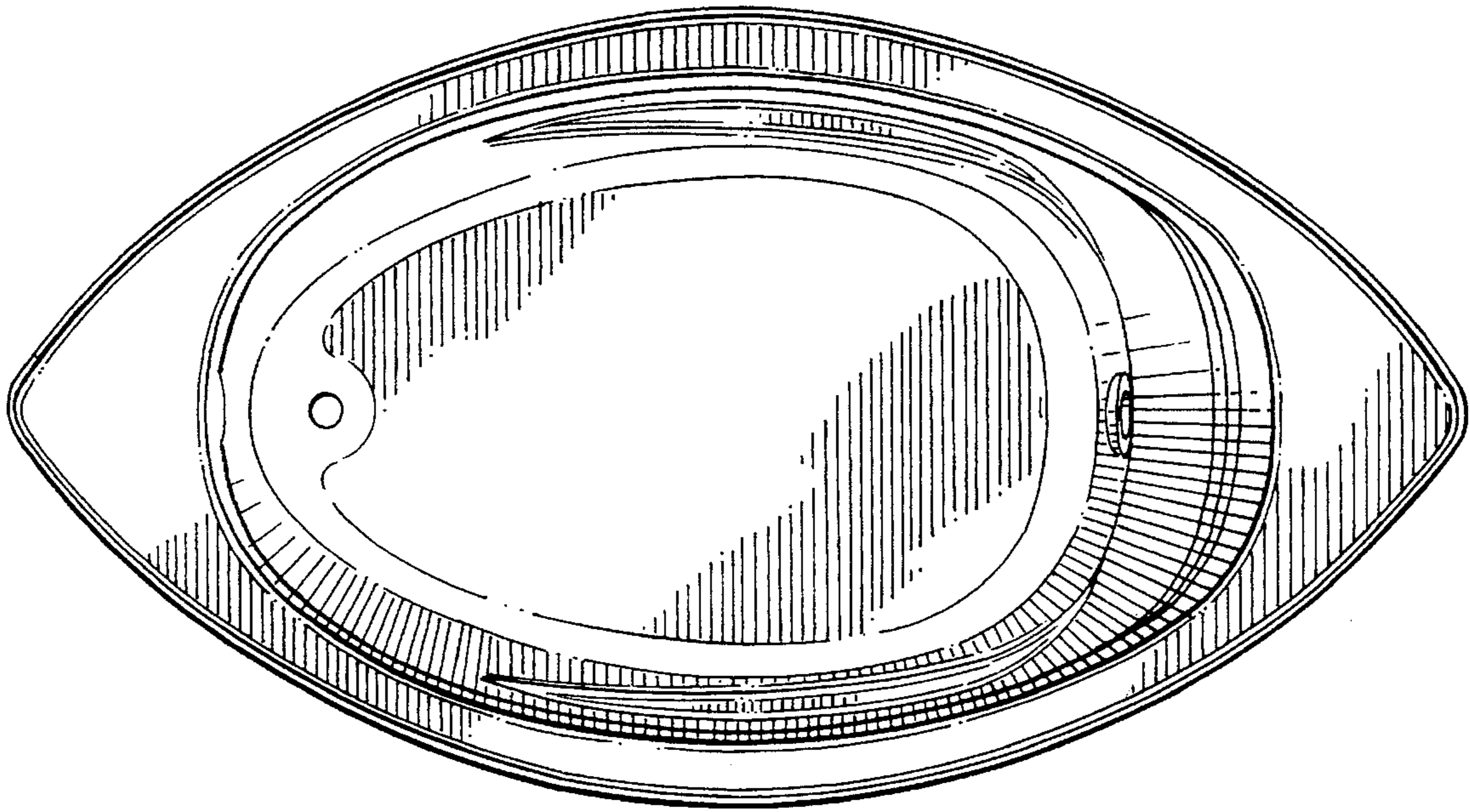

FIG. 3

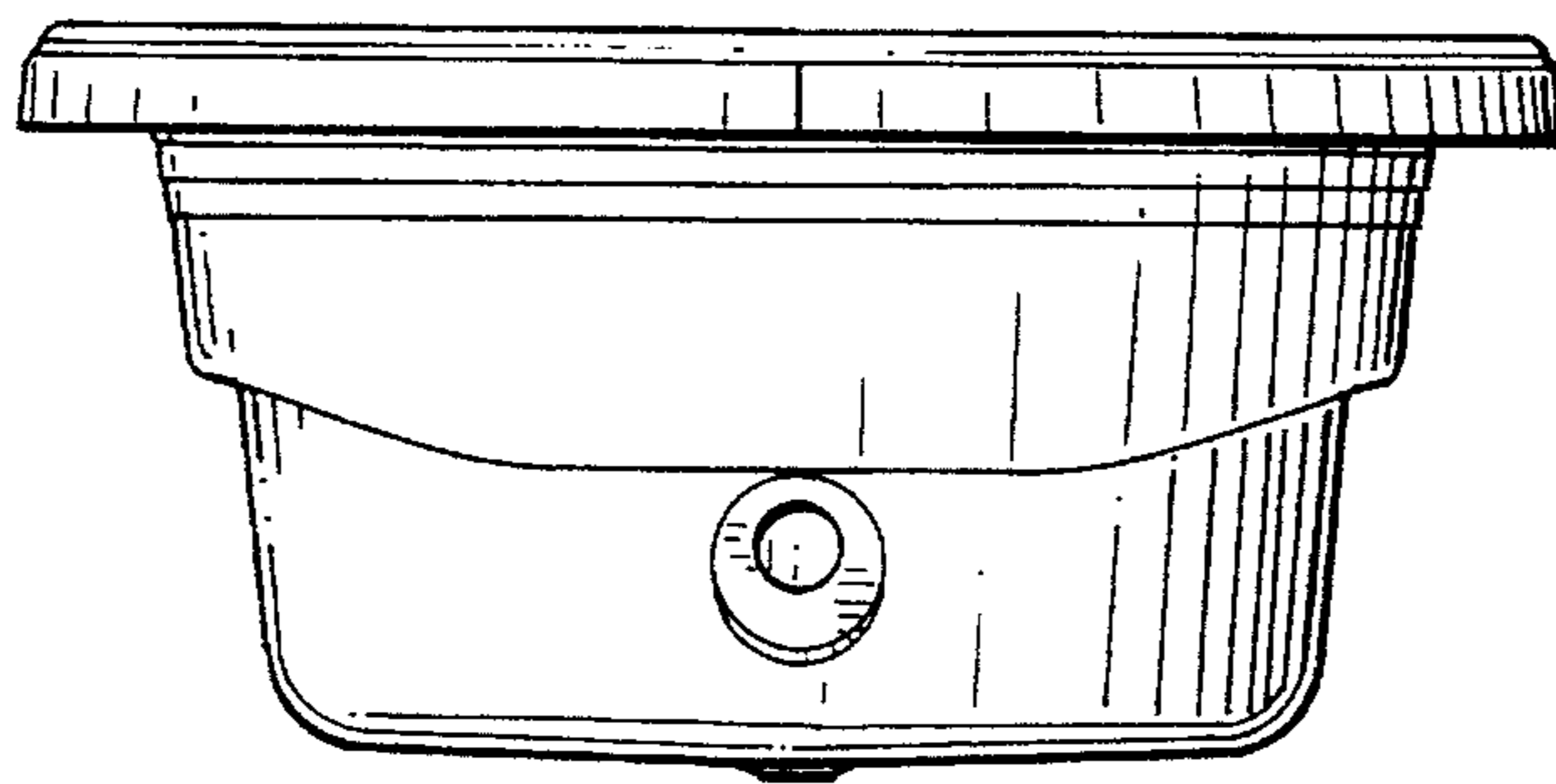

FIG. 4

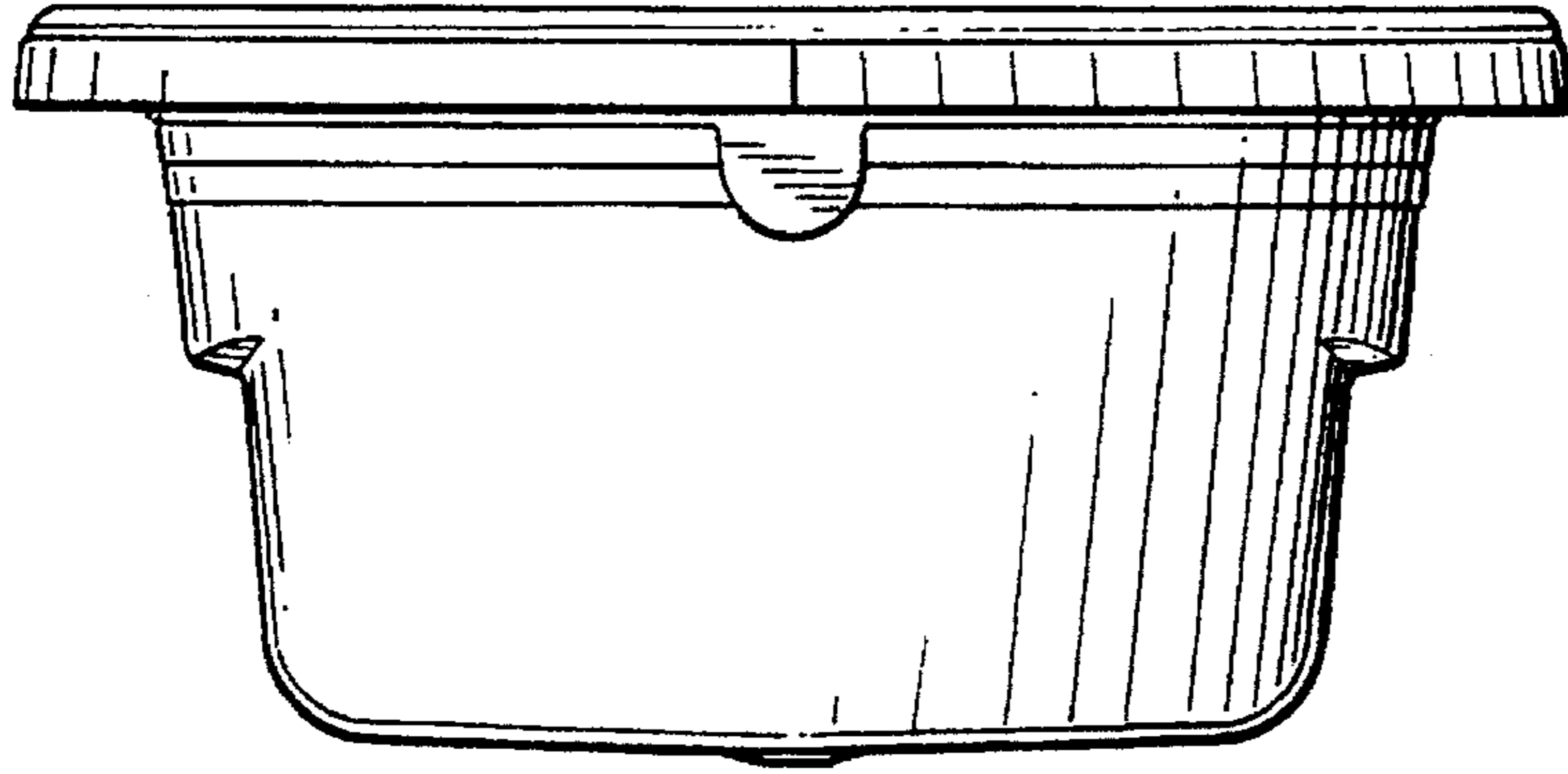

FIG. 5

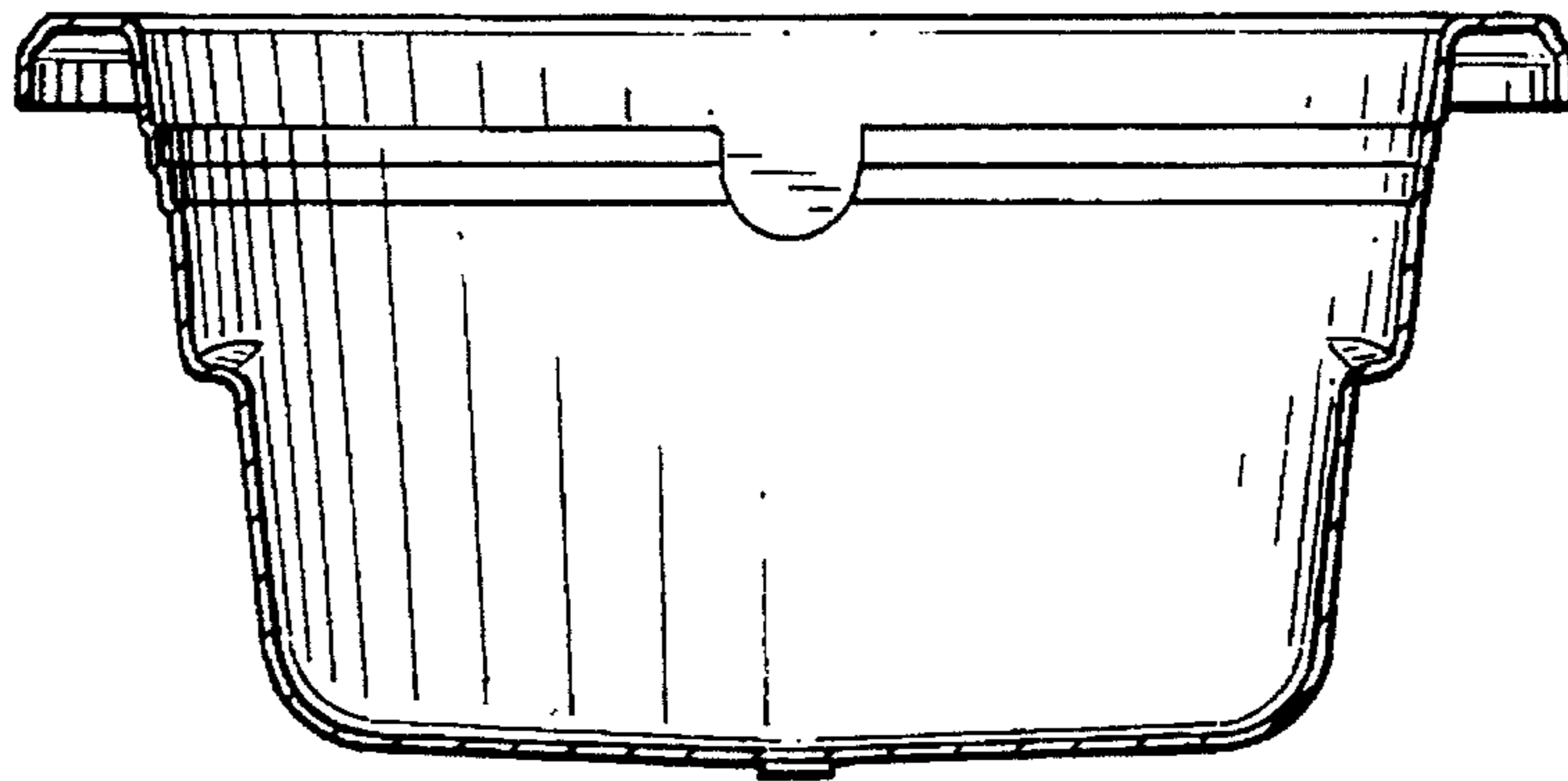

FIG. 6

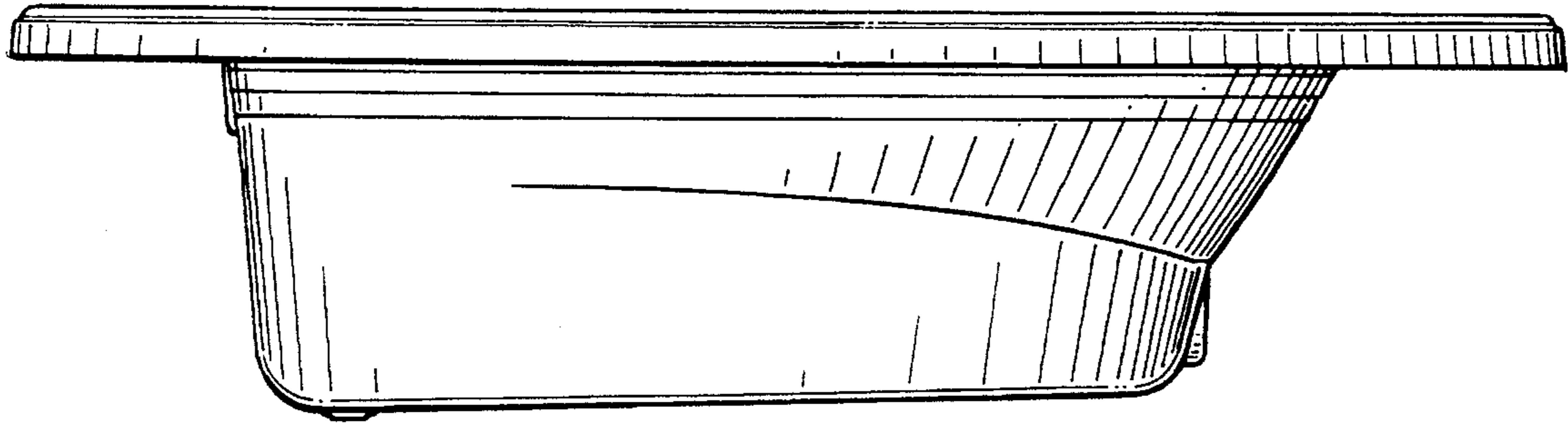

FIG. 7

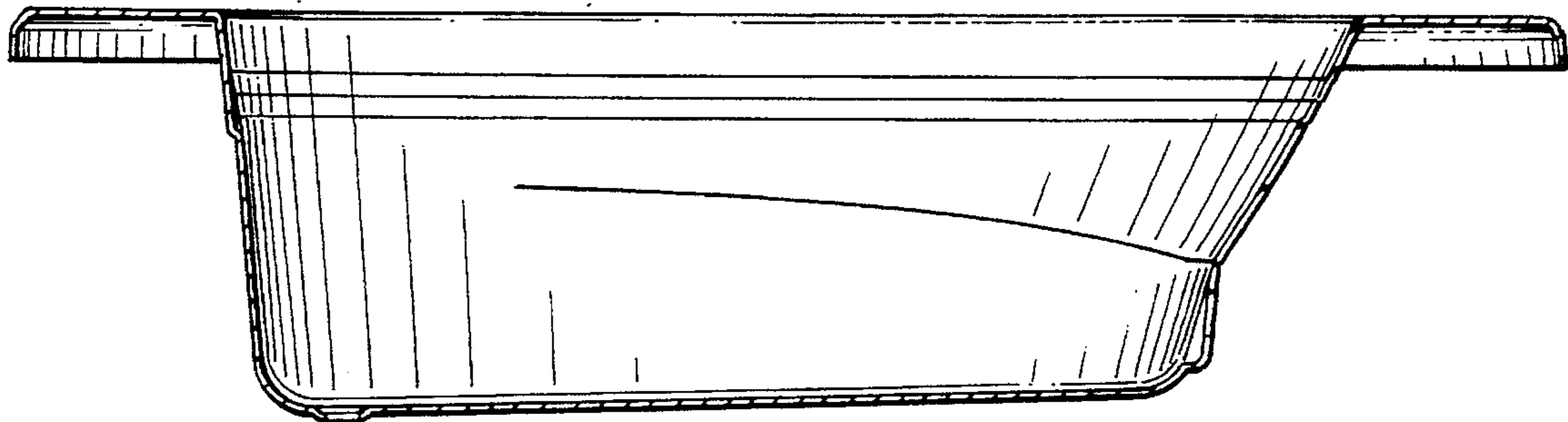

FIG. 8