



US00D375095S

United States Patent [19]

[11] **Patent Number: Des. 375,095**

Hillenmayer et al.

[45] **Date of Patent: **Oct. 29, 1996**

[54] **TELEPHONE**

[57] **CLAIM**

[75] Inventors: **Stefan Hillenmayer; Ulrich Skrypalle**, both of Munich, Germany; **Wayne E. McKinnon**, Georgetown, Tex.; **David E. Bryant**, Austin, Tex.; **Mary E. Kingsbury**, Dallas, Tex.; **Erich C. Elkins**, San Francisco, Calif.; **Doug A. Erwin**, Austin, Tex.

The ornamental design for a telephone, as shown and described.

DESCRIPTION

[73] Assignee: **Siemens Rolm Communications Inc.**, Santa Clara, Calif.

FIG. 1 is a first perspective view of a first embodiment of the telephone of the present invention, with a display rotated toward the body of the telephone;

[**] Term: **14 Years**

FIG. 2 is a second perspective view of the first embodiment, with the display rotated away from the body of the telephone;

[21] Appl. No.: **40,263**

FIG. 3 is a top view of the first embodiment;

[22] Filed: **Jun. 14, 1995**

FIG. 4 is a front elevational view of the first embodiment;

[52] **U.S. Cl.** **D14/151**

FIG. 5 is a right-side elevational view of the first embodiment;

[58] **Field of Search** **D14/140, 142, D14/149-151, 147, 148, 240, 241, 137, 138; 379/434-436, 419, 420, 428, 440, 454, 455**

FIG. 6 is a left-side elevational view of the first embodiment;

FIG. 7 is a rear elevational view of the first embodiment;

FIG. 8 is a bottom view of the first embodiment;

FIG. 9 is a first perspective view of a second embodiment of the telephone of the present invention, with a display rotated toward the body of the telephone;

[56] **References Cited**

U.S. PATENT DOCUMENTS

D. 297,137	8/1988	Richter et al.	D14/151
D. 311,191	10/1990	Ando	D14/241
D. 311,399	10/1990	Ando	D14/241
D. 319,235	8/1991	Sato	D14/151
D. 319,443	8/1991	Fuqua et al.	D14/241 X
D. 339,583	9/1993	Taniguchi	D14/151
D. 346,384	4/1994	Ford et al.	D14/151
D. 346,385	4/1994	Wetzel et al.	D14/151
3,941,951	3/1976	Engstrom et al.	379/436
4,790,007	12/1988	Richter et al.	379/435 X
5,121,427	6/1992	Gumb et al.	379/435

FIG. 10 is a second perspective view of the second embodiment, with the display rotated away from the body of the telephone;

FIG. 11 is a top view of the second embodiment;

FIG. 12 is a front elevational view of the second embodiment;

FIG. 13 is a right-side elevational view of the second embodiment;

FIG. 14 is a left-side elevational view of the second embodiment;

FIG. 15 is a rear elevational view of the second embodiment; and,

FIG. 16 is a bottom view of the second embodiment.

Primary Examiner—Jeffrey Asch

1 Claim, 8 Drawing Sheets

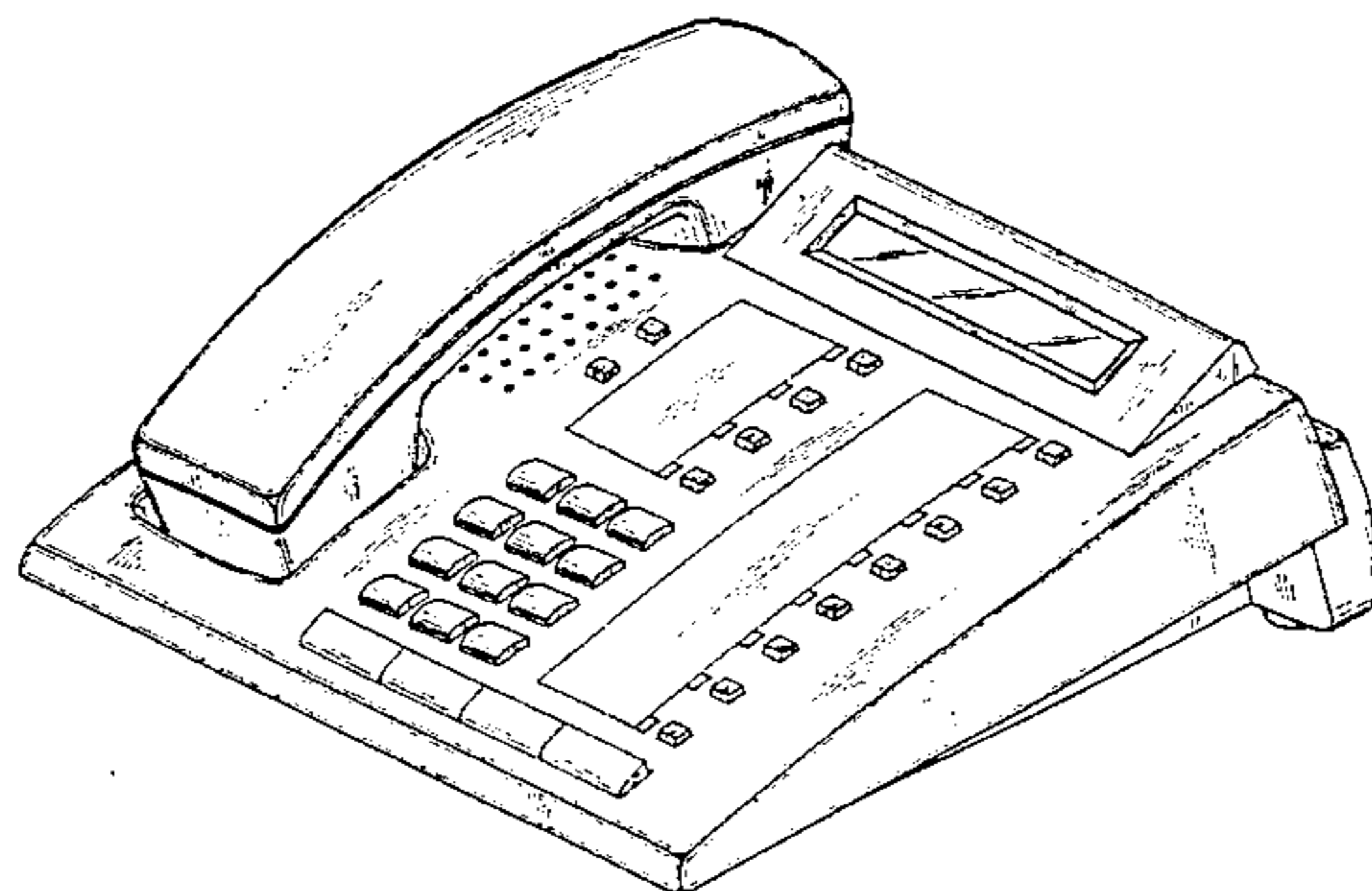
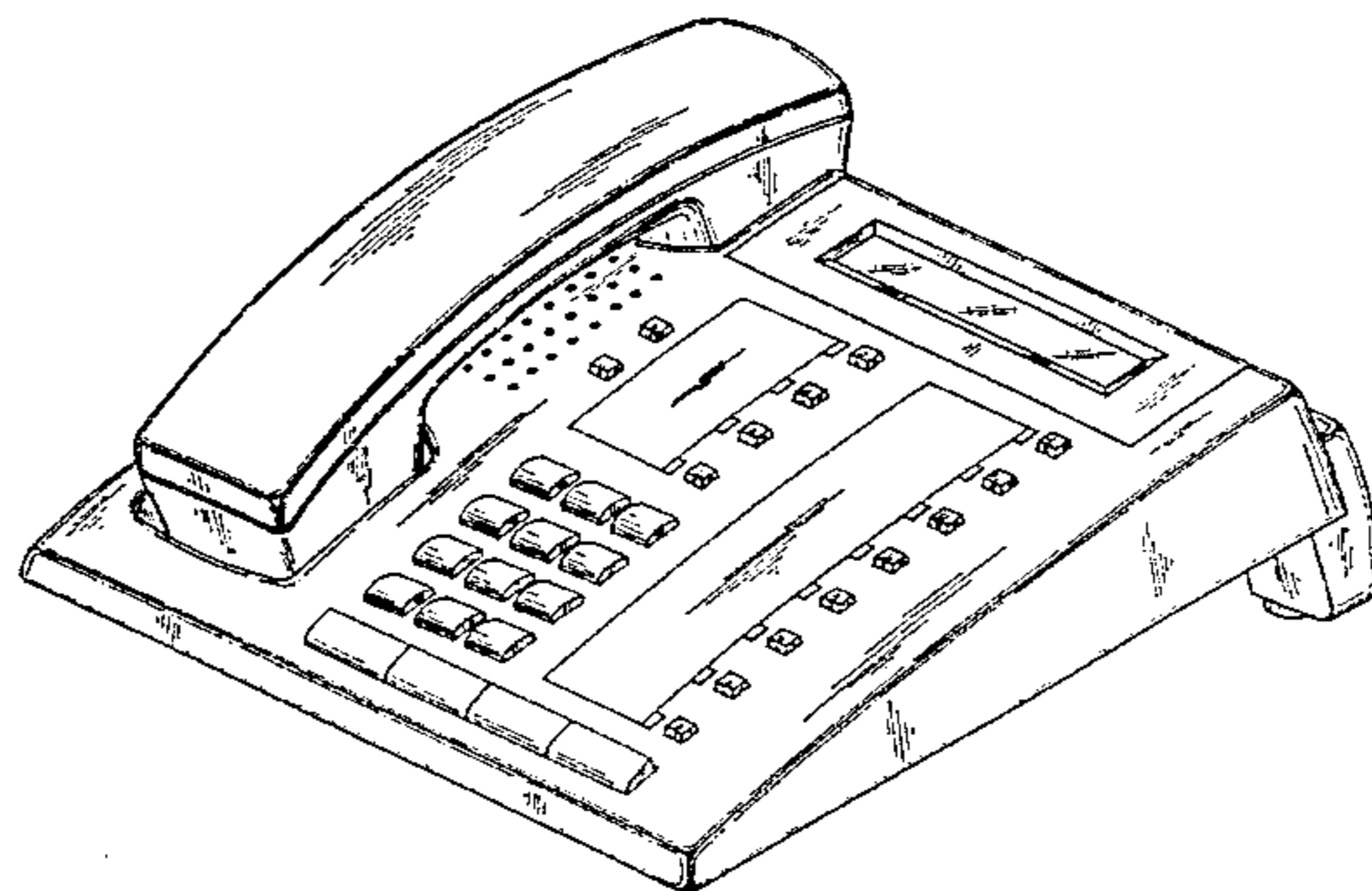

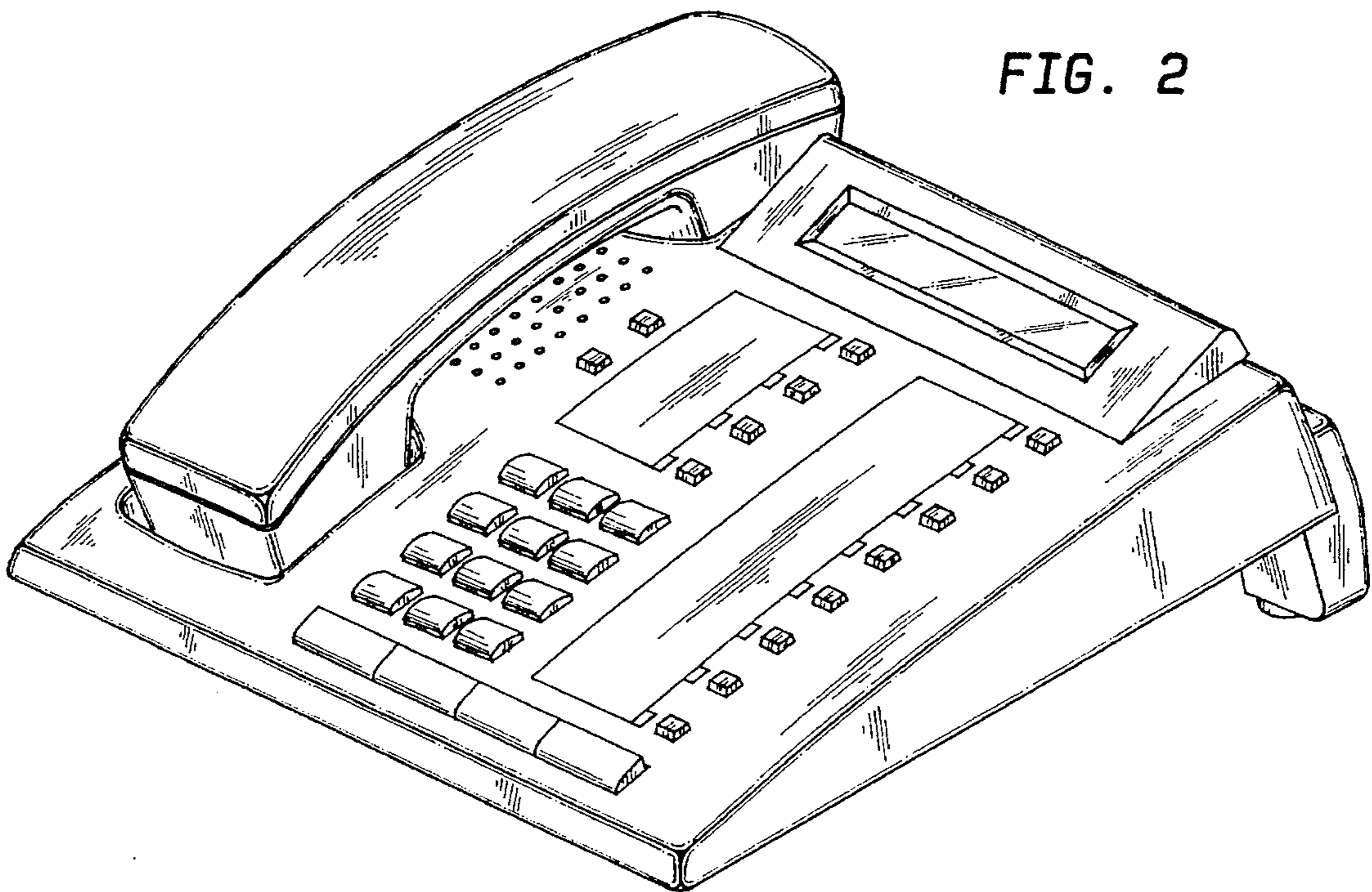
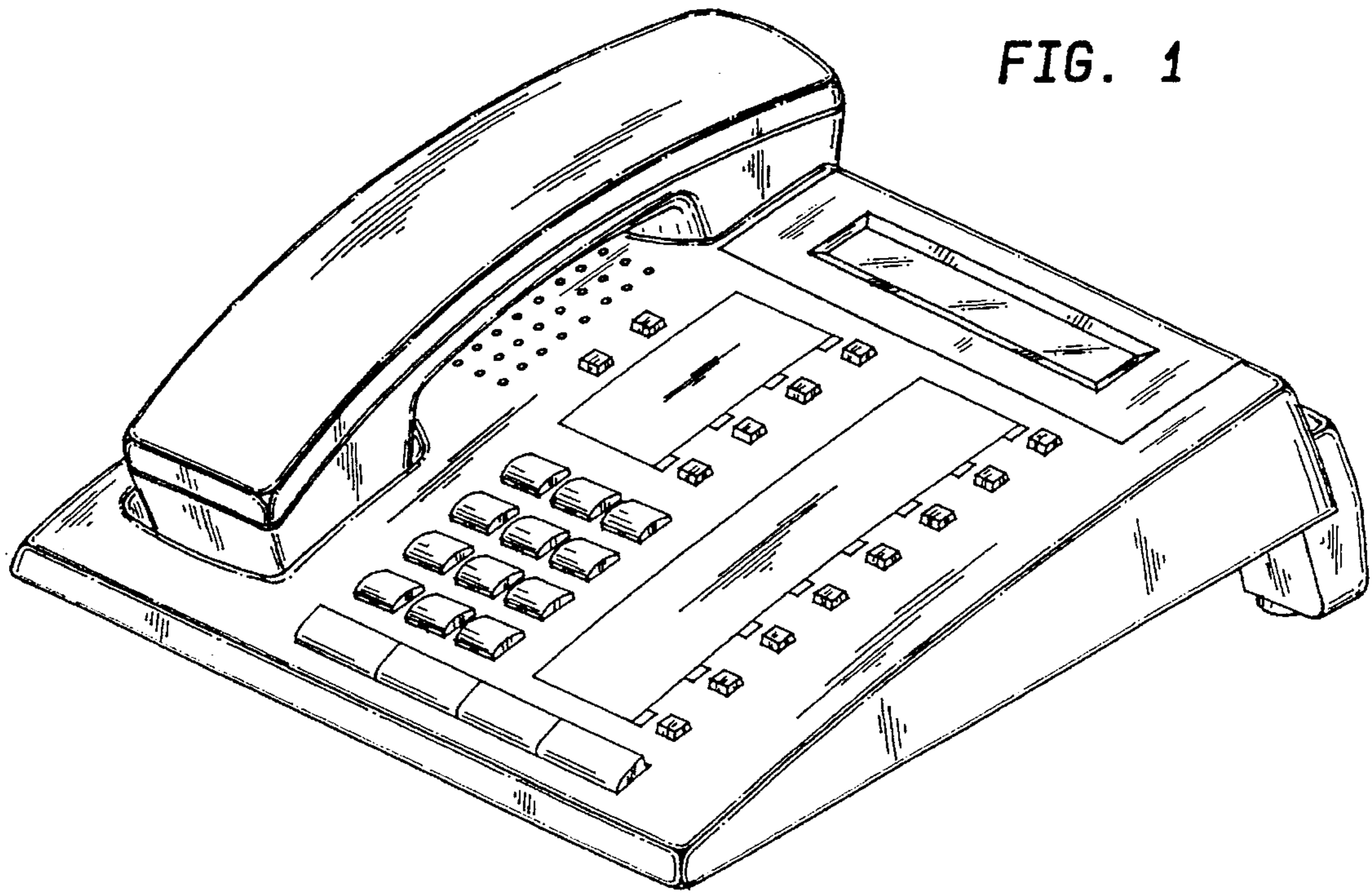

FIG. 3

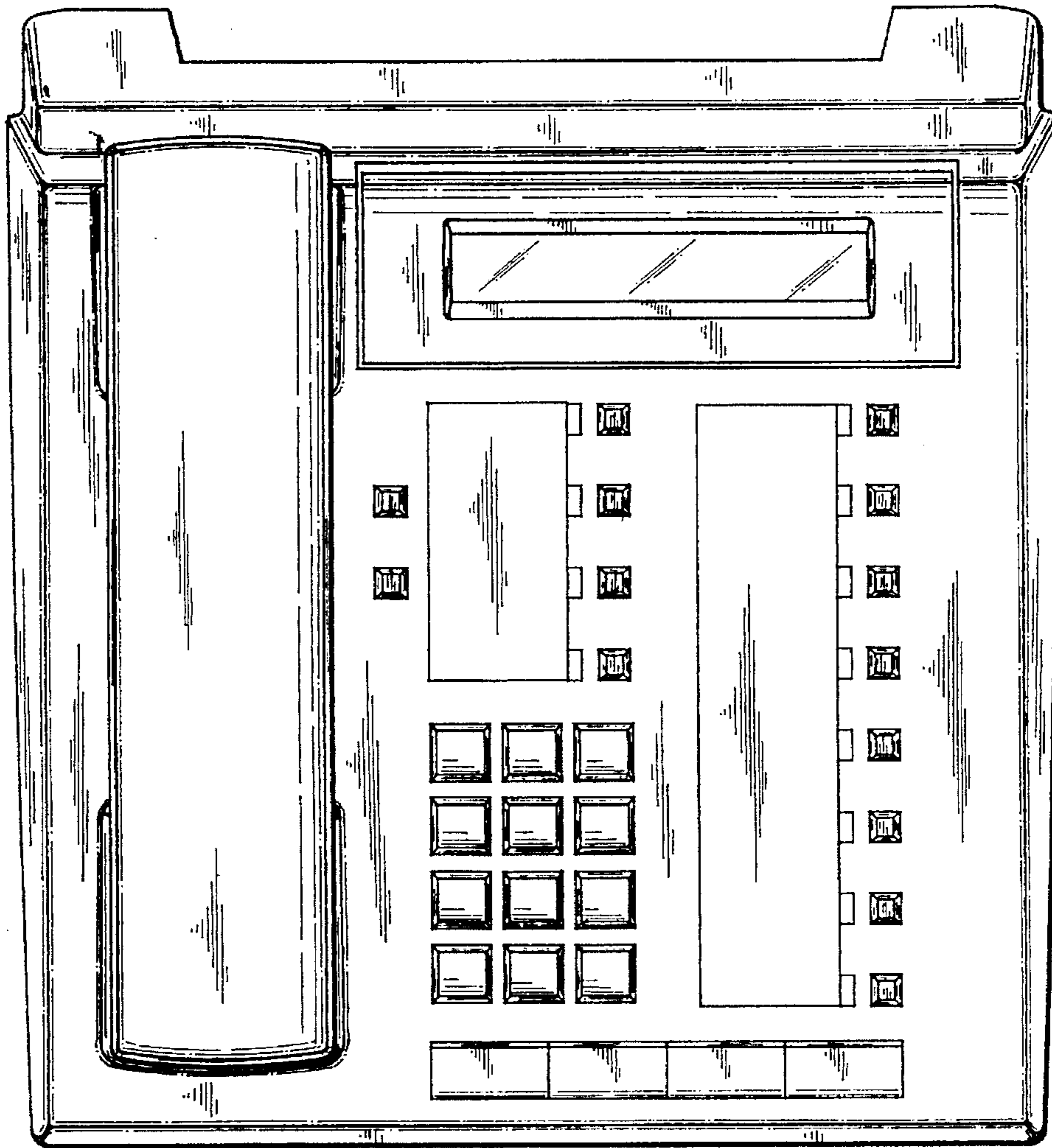

FIG. 4

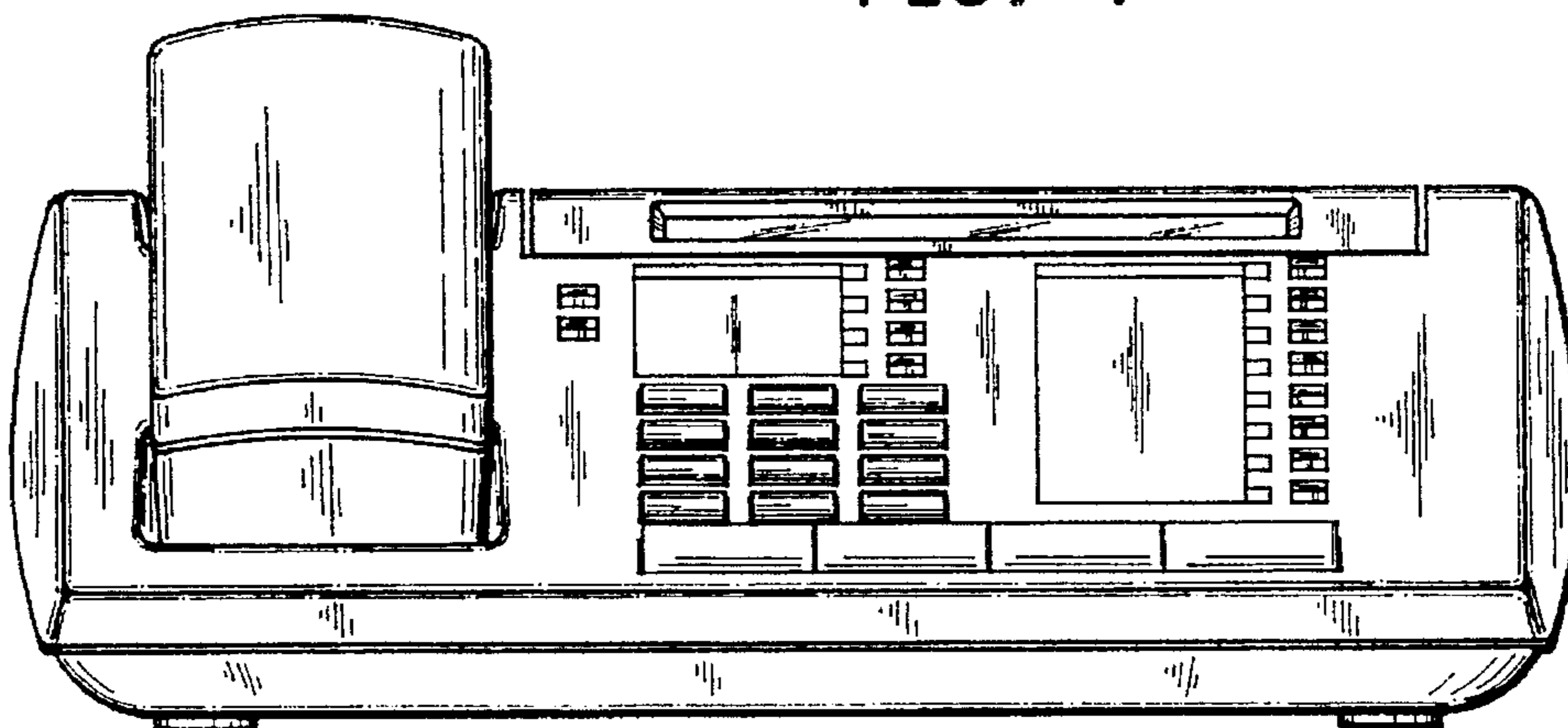

FIG. 5

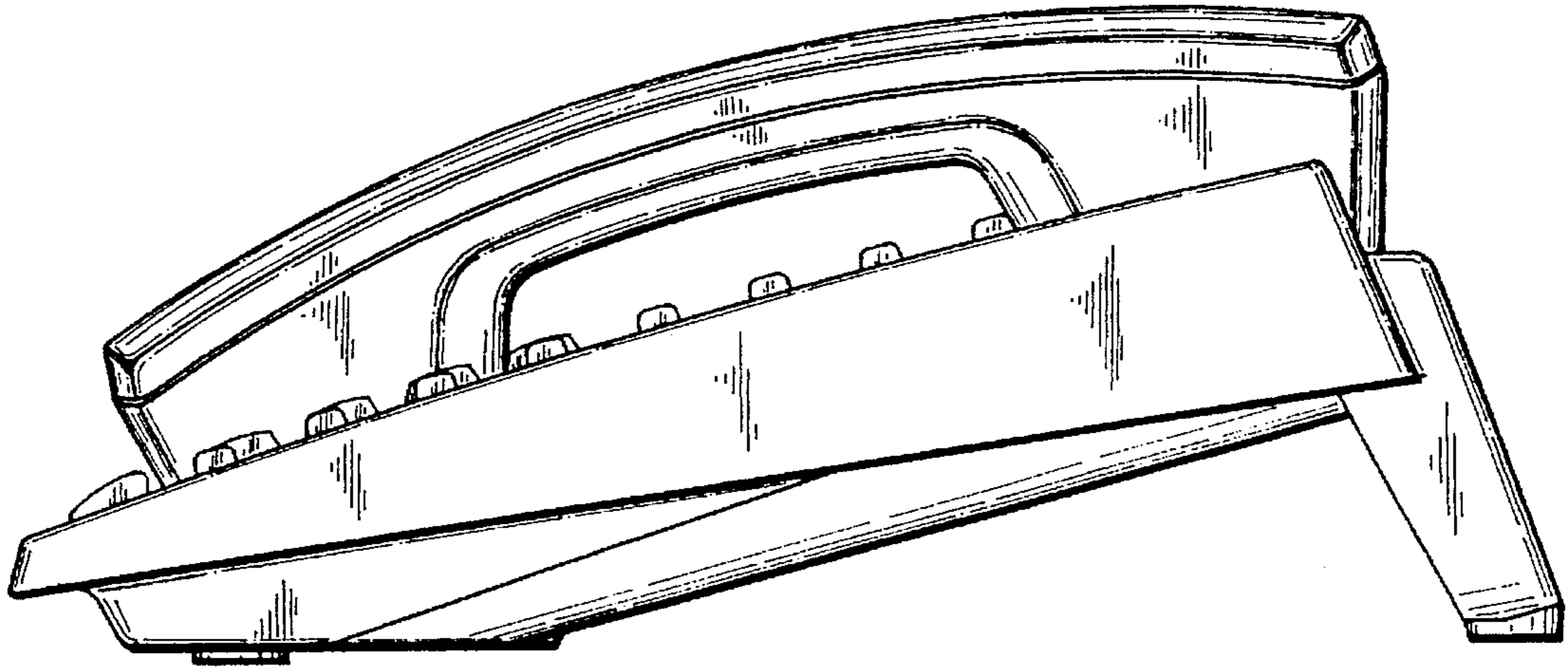

FIG. 6

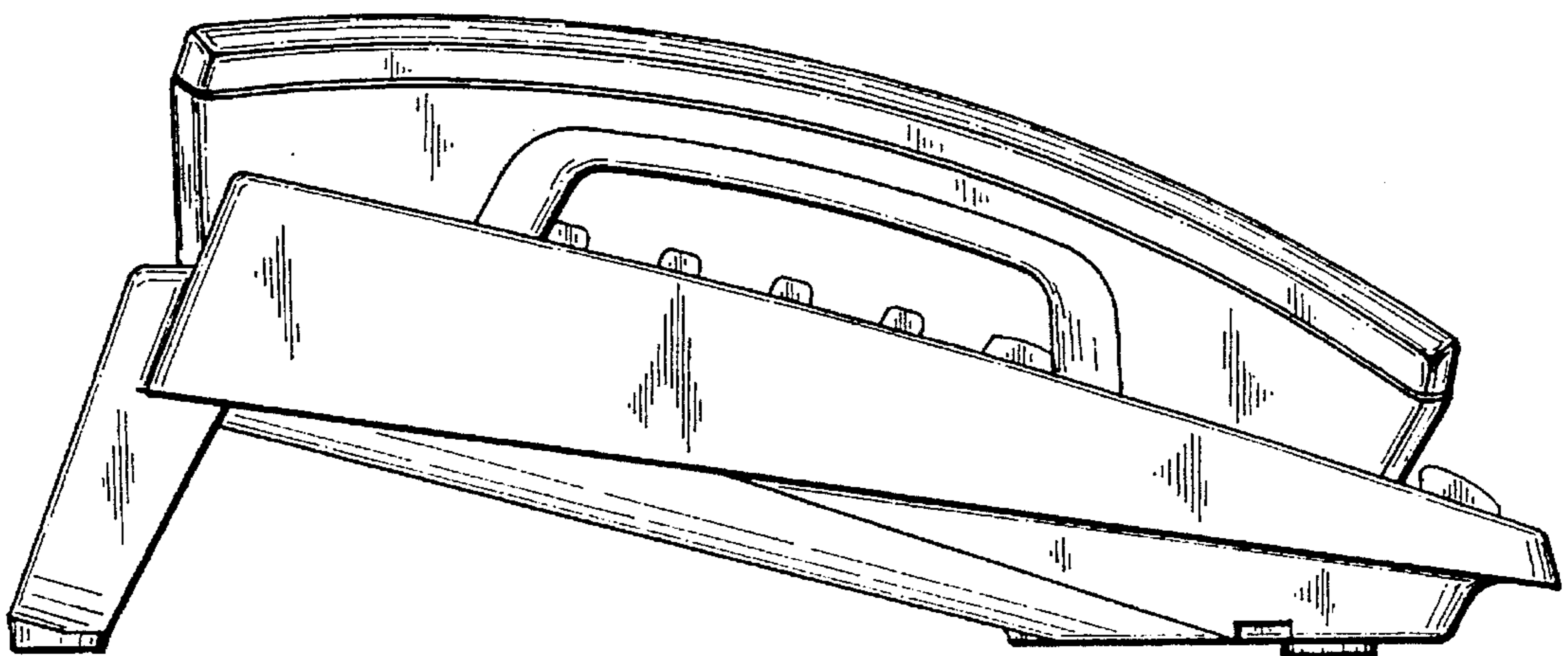

FIG. 7

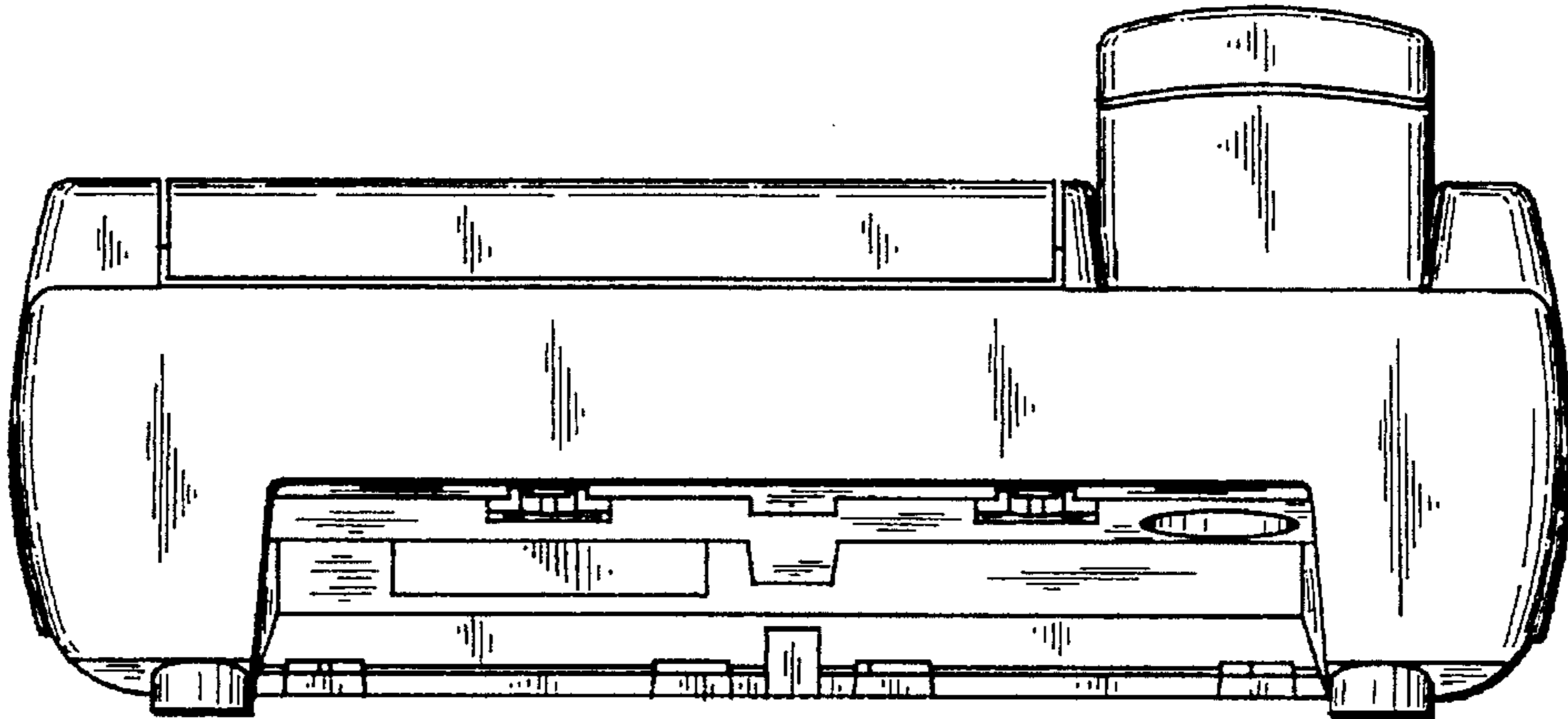
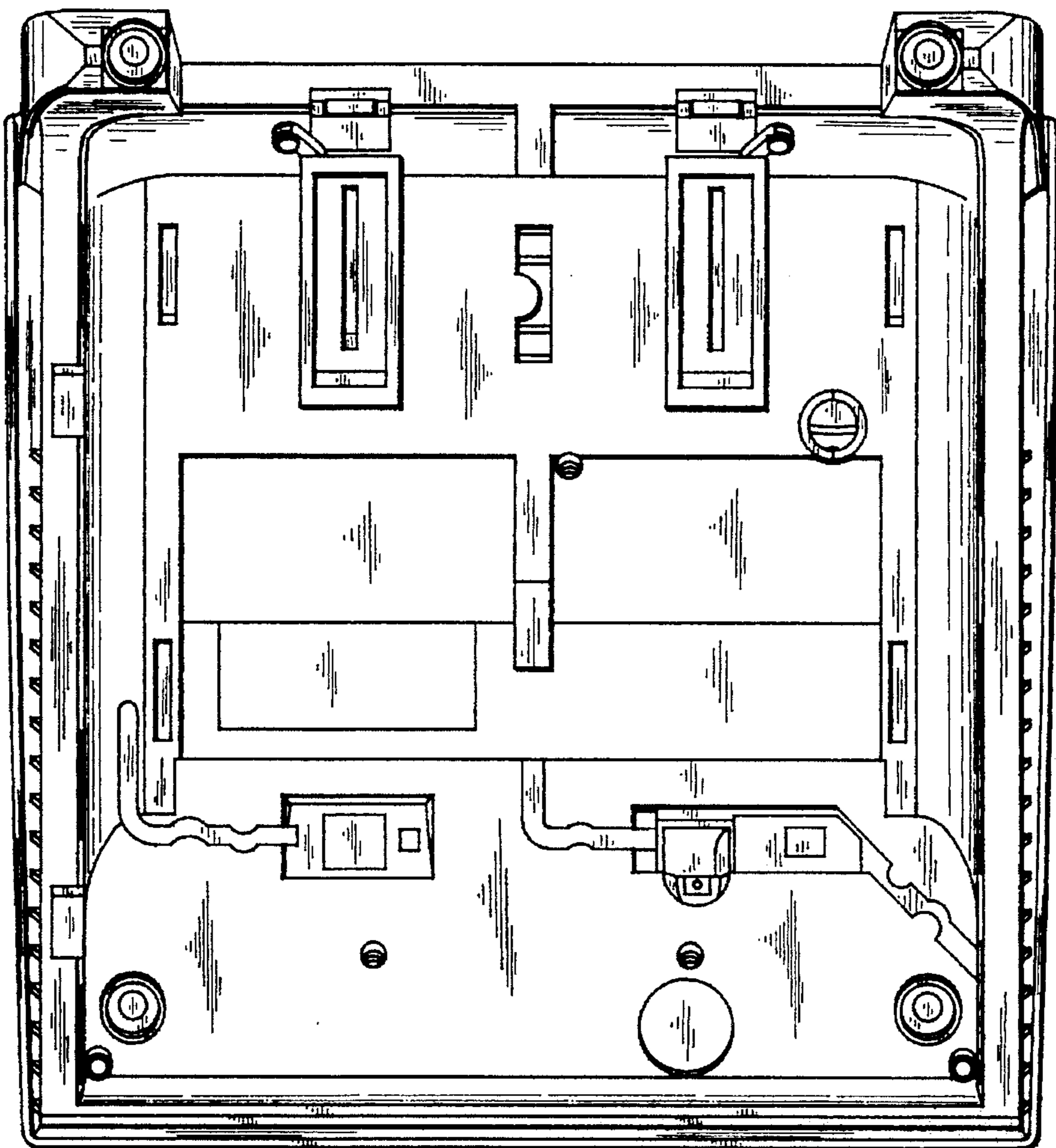

FIG. 8



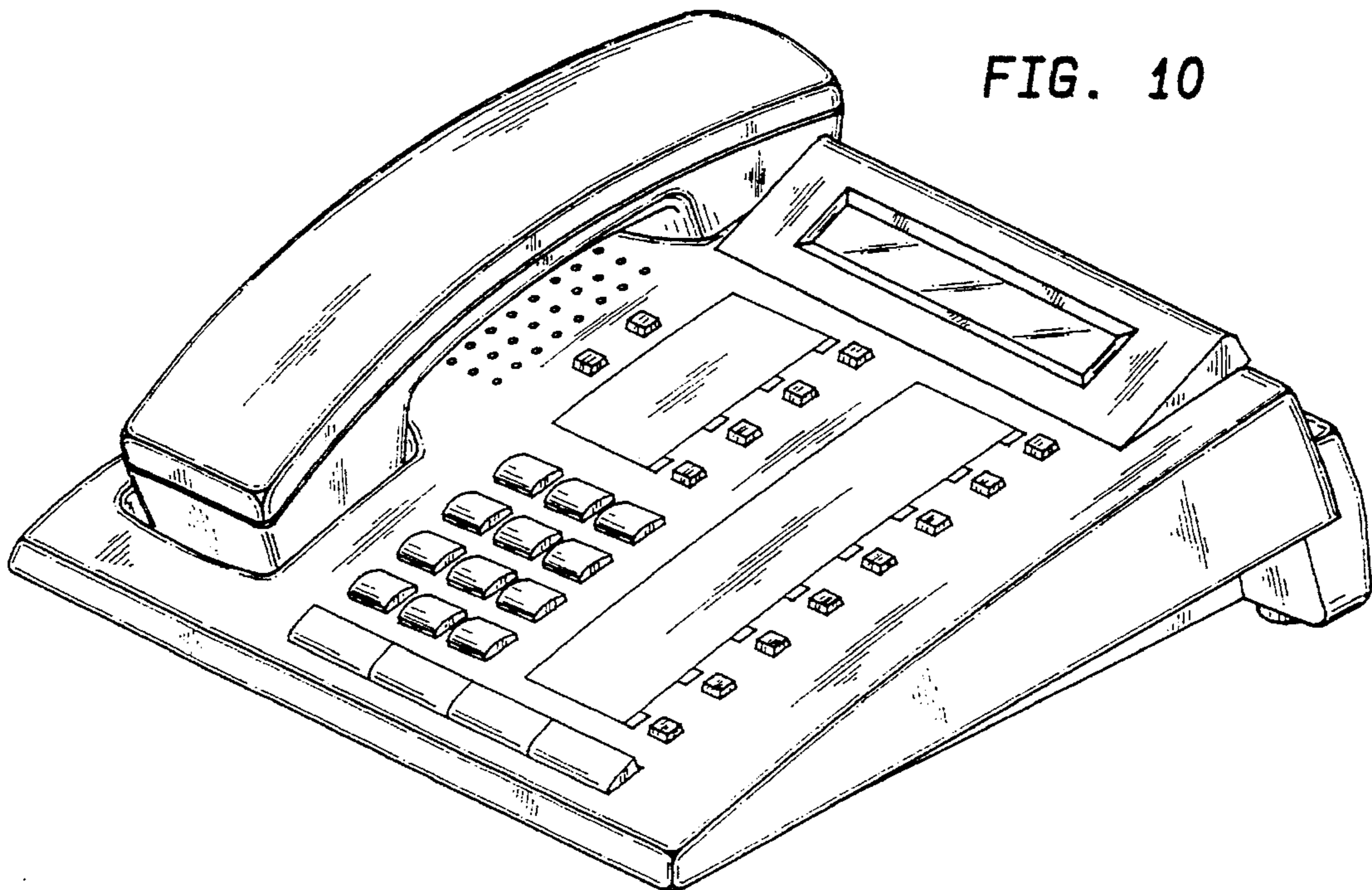
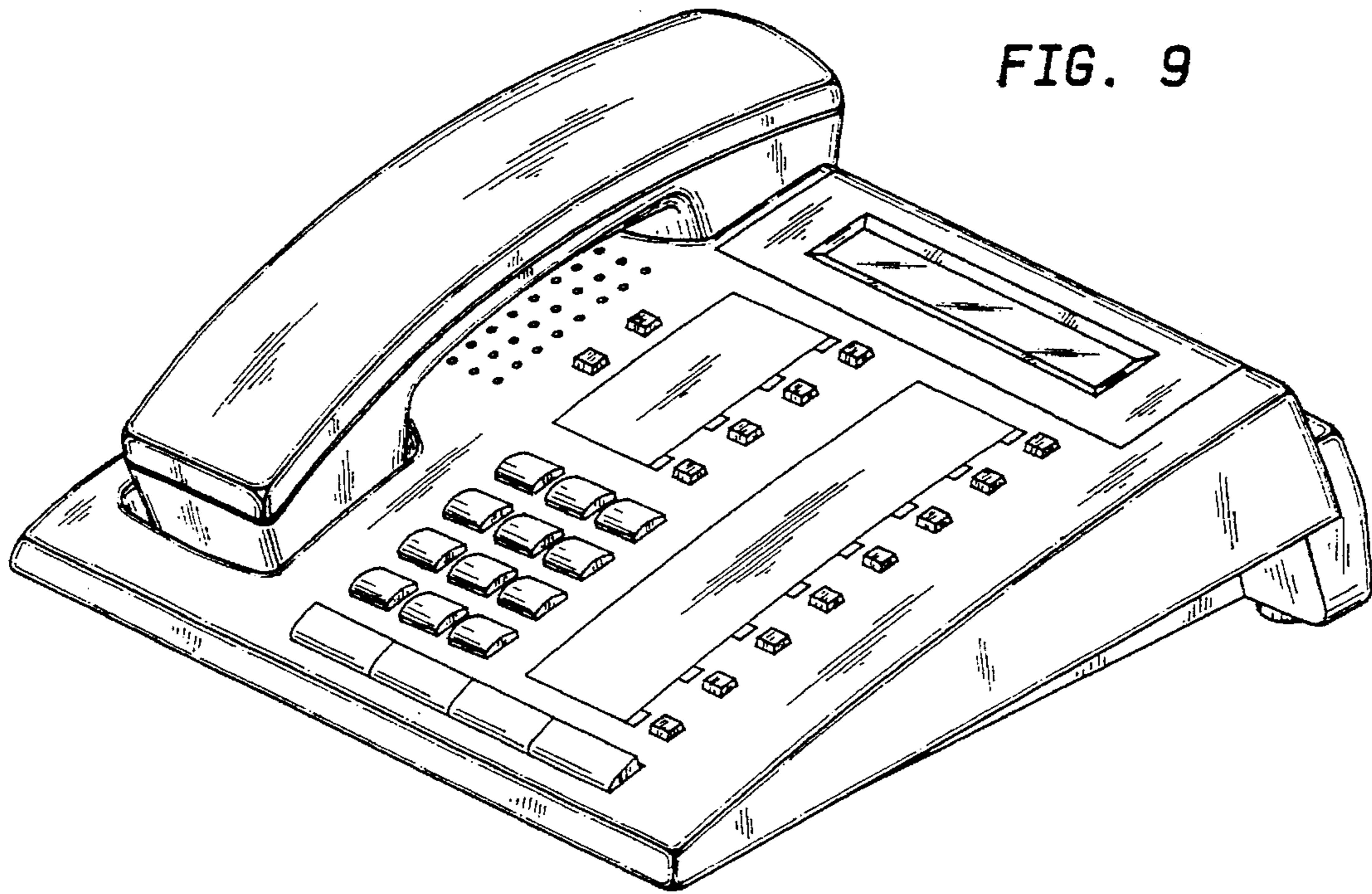

FIG. 11

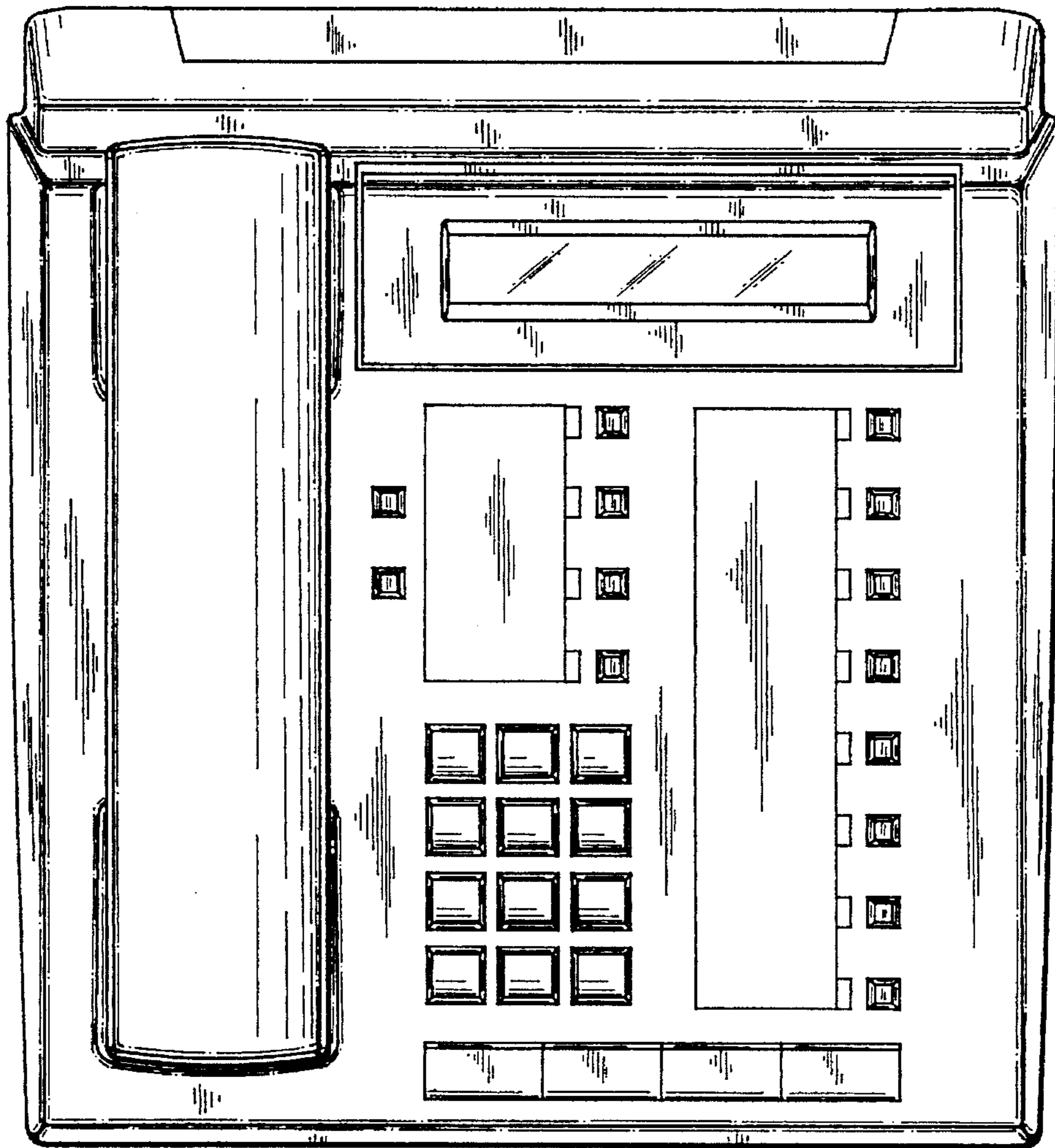

FIG. 12

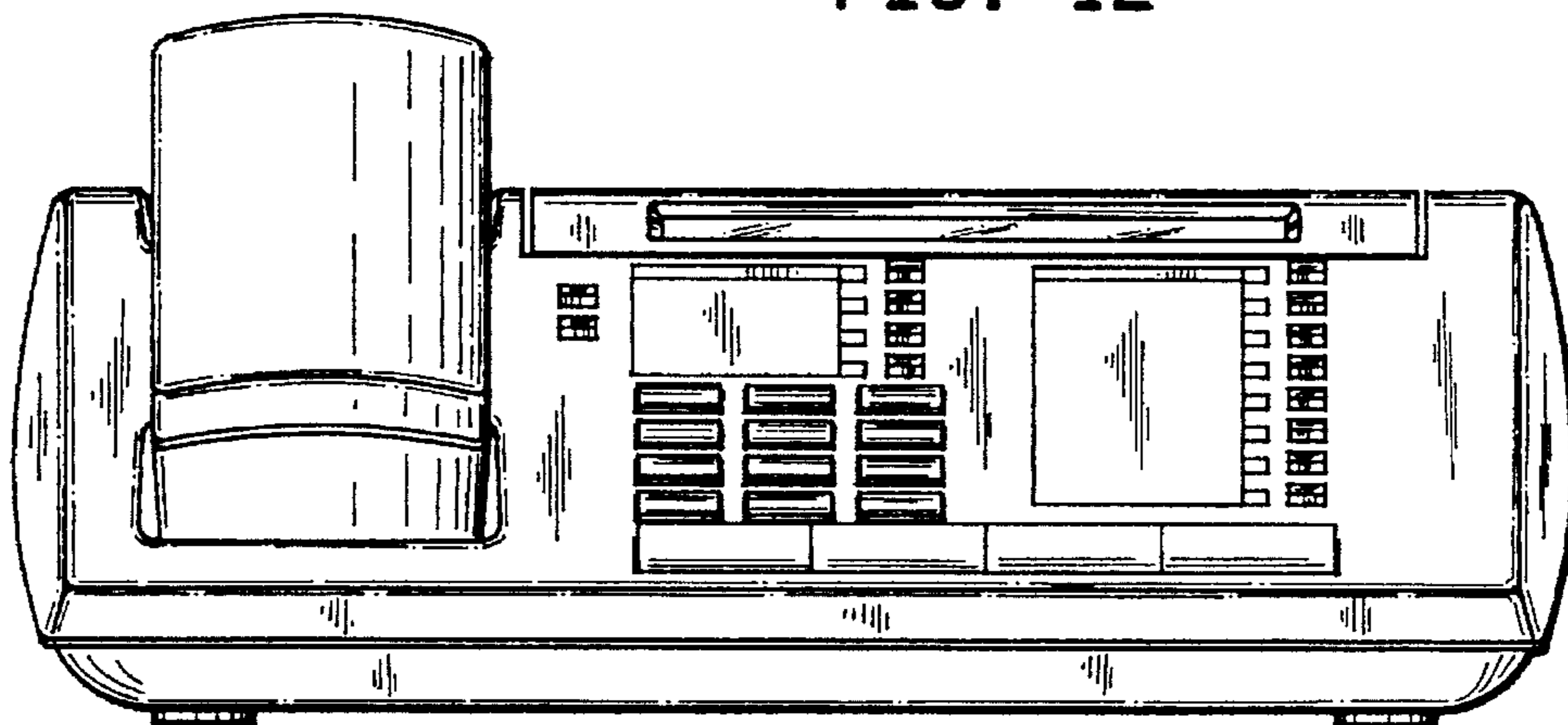

FIG. 13

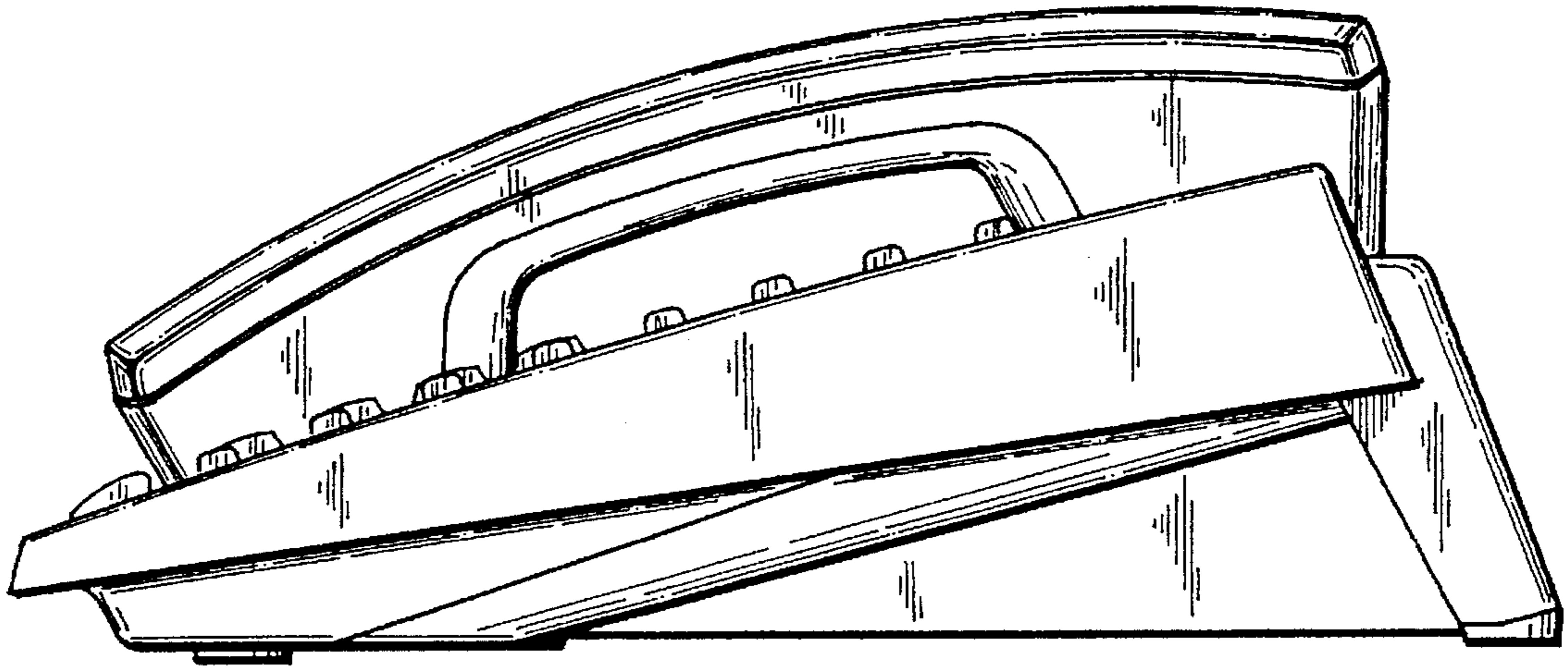

FIG. 14

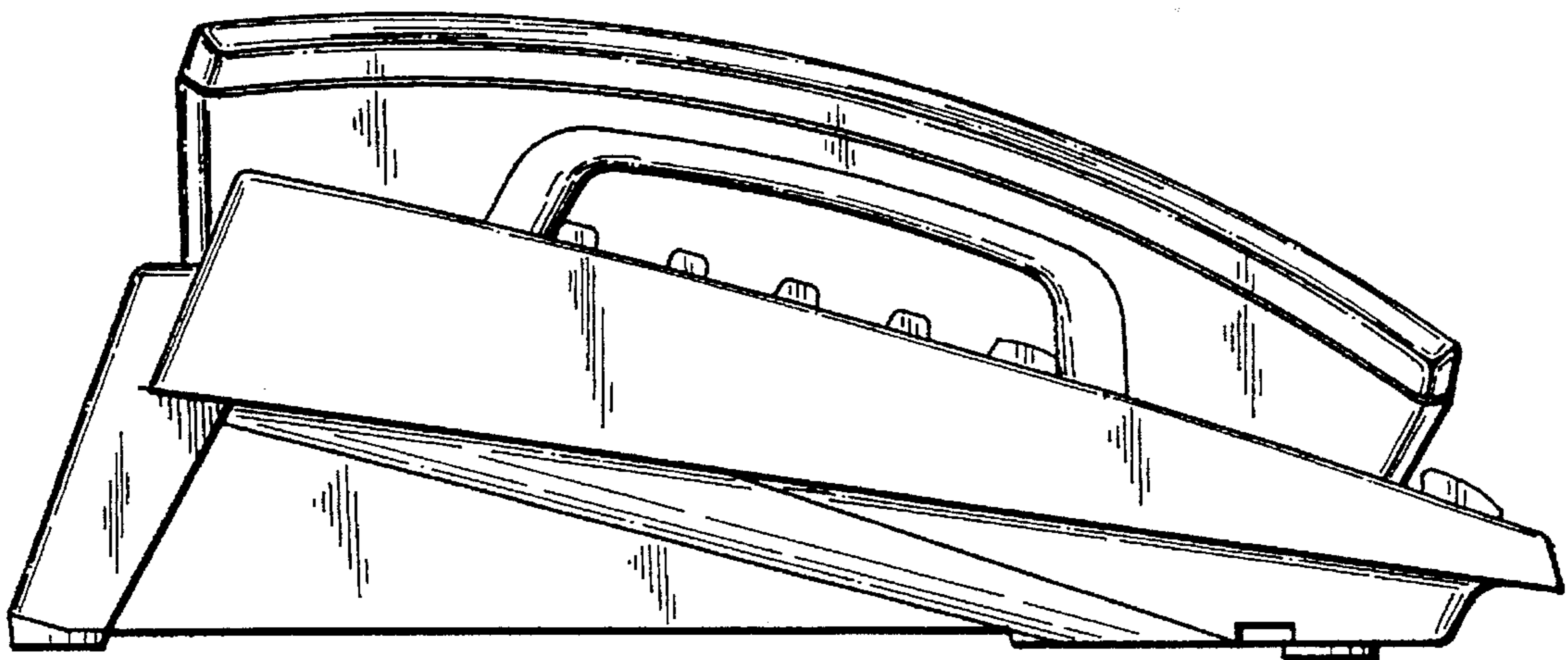

FIG. 15

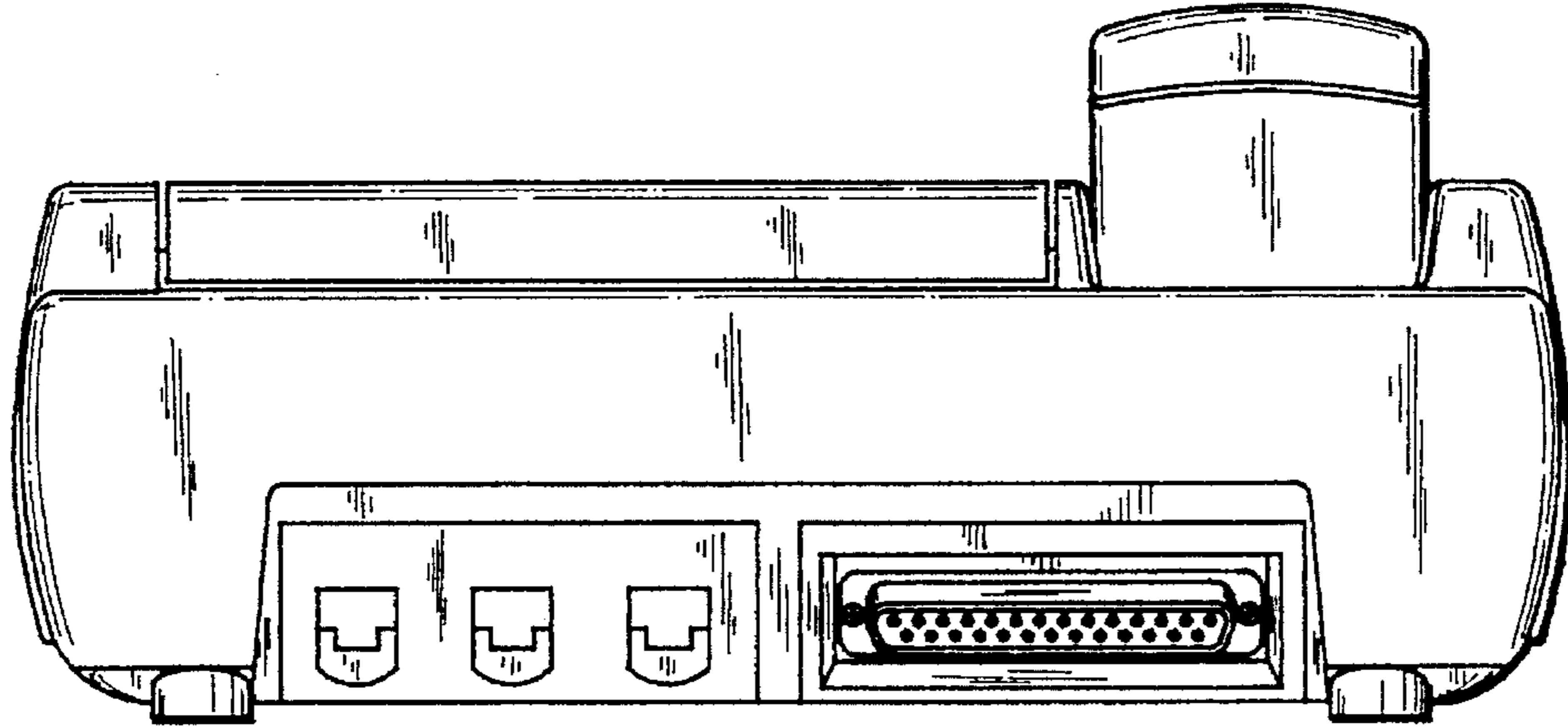

FIG. 16

