



US00D375092S

# United States Patent [19]

Hilsenrath et al.

[11] Patent Number: **Des. 375,092**

[45] Date of Patent: **\*\*Oct. 29, 1996**

[54] **PORTABLE COMMUNICATIONS TERMINAL**

[75] Inventors: **Oliver Hilsenrath**, Ridgewood, N.J.;  
**John Moon**, East Northport, N.Y.;  
**William A. Opet**, Wayne, Pa.

[73] Assignee: **Geotek Communications, Inc.**,  
Montvale, N.J.

[\*\*] Term: **14 Years**

[21] Appl. No.: **35,235**

[22] Filed: **Feb. 17, 1995**

[52] U.S. Cl. .... **D14/142; D14/148**

[58] Field of Search ..... **D14/140, 142,**  
**D14/137, 138, 147, 148, 149-151, 144,**  
**141, 240, 241, 248, 101; D10/46, 104,**  
**106; 379/419, 420, 428, 440, 434-436,**  
**454, 455, 58-61; 455/89, 90**

[56] **References Cited**

**U.S. PATENT DOCUMENTS**

D. 279,372	6/1985	Baba et al. ....	D14/148 X
D. 287,011	12/1986	Kaku .....	D14/151
D. 294,250	2/1988	Watanabe et al. ....	D14/151 X
D. 313,595	1/1991	Morooka .....	D14/144 X

D. 315,154	3/1991	Iizuka et al. ....	D14/151
D. 325,730	4/1992	Van Der Zon .....	D14/142 X
D. 327,679	7/1992	Nakamachi et al. ....	D14/142 X
D. 339,342	9/1993	Chan .....	D14/149
D. 348,667	7/1994	Oksman .....	D14/148
D. 353,342	12/1994	King et al. ....	D10/46 X
D. 359,283	6/1995	Rudkiewicz .....	D14/149
4,881,258	11/1989	Kaiwa et al. ....	455/90 X

*Primary Examiner*—Jeffrey Asch  
*Attorney, Agent, or Firm*—Cobrin Gittes & Samuel

[57] **CLAIM**

The ornamental design for a portable communications terminal, as shown.

**DESCRIPTION**

FIG. 1 is a perspective of a portable communications terminal showing our new design;  
FIG. 2 is a top plan view thereof;  
FIG. 3 is a front elevational view thereof;  
FIG. 4 is a left side elevational view thereof;  
FIG. 5 is a right side elevational view thereof;  
FIG. 6 is a rear elevational view thereof; and,  
FIG. 7 is a bottom plan view thereof.

**1 Claim, 4 Drawing Sheets**

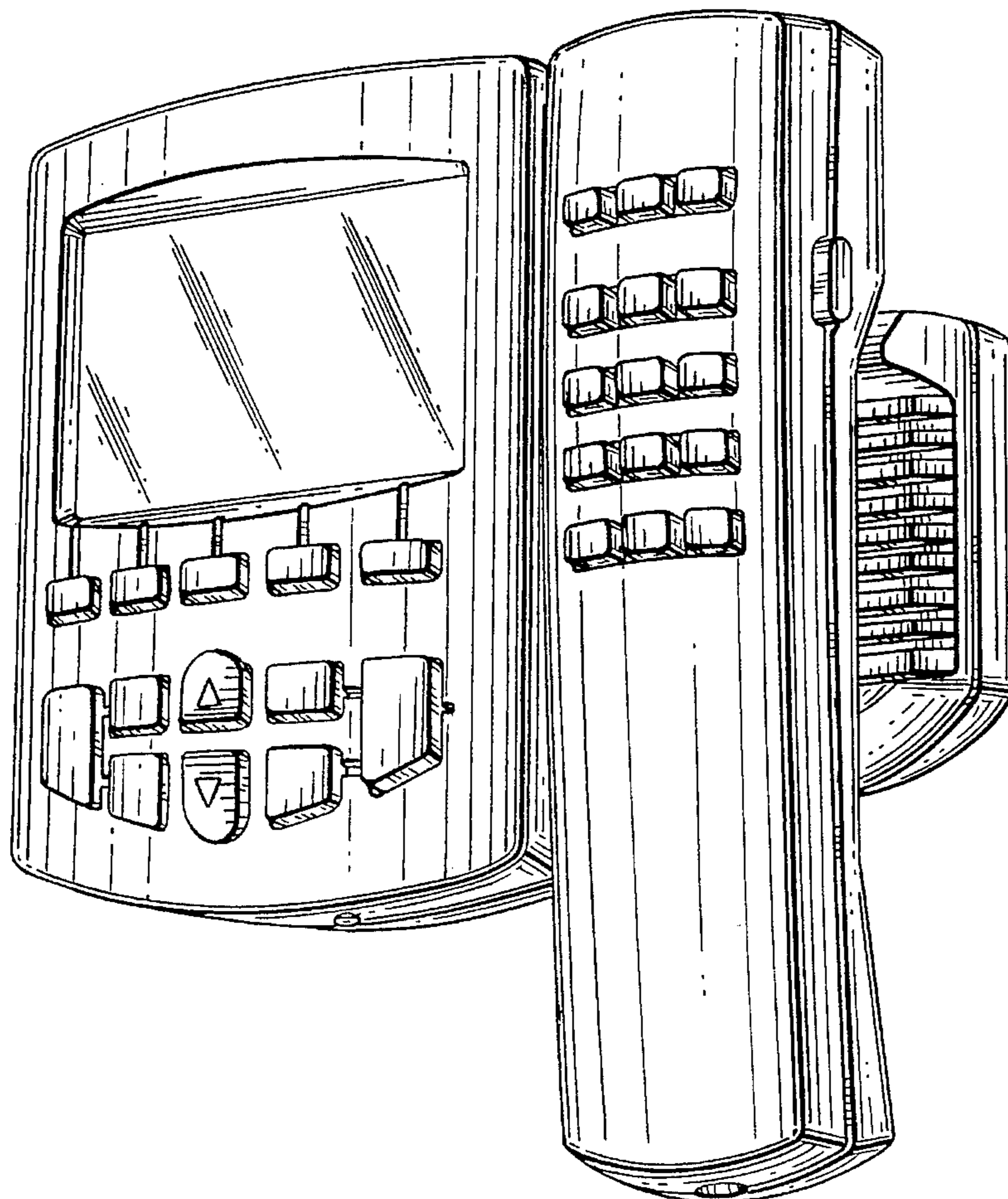

*FIG. 1*

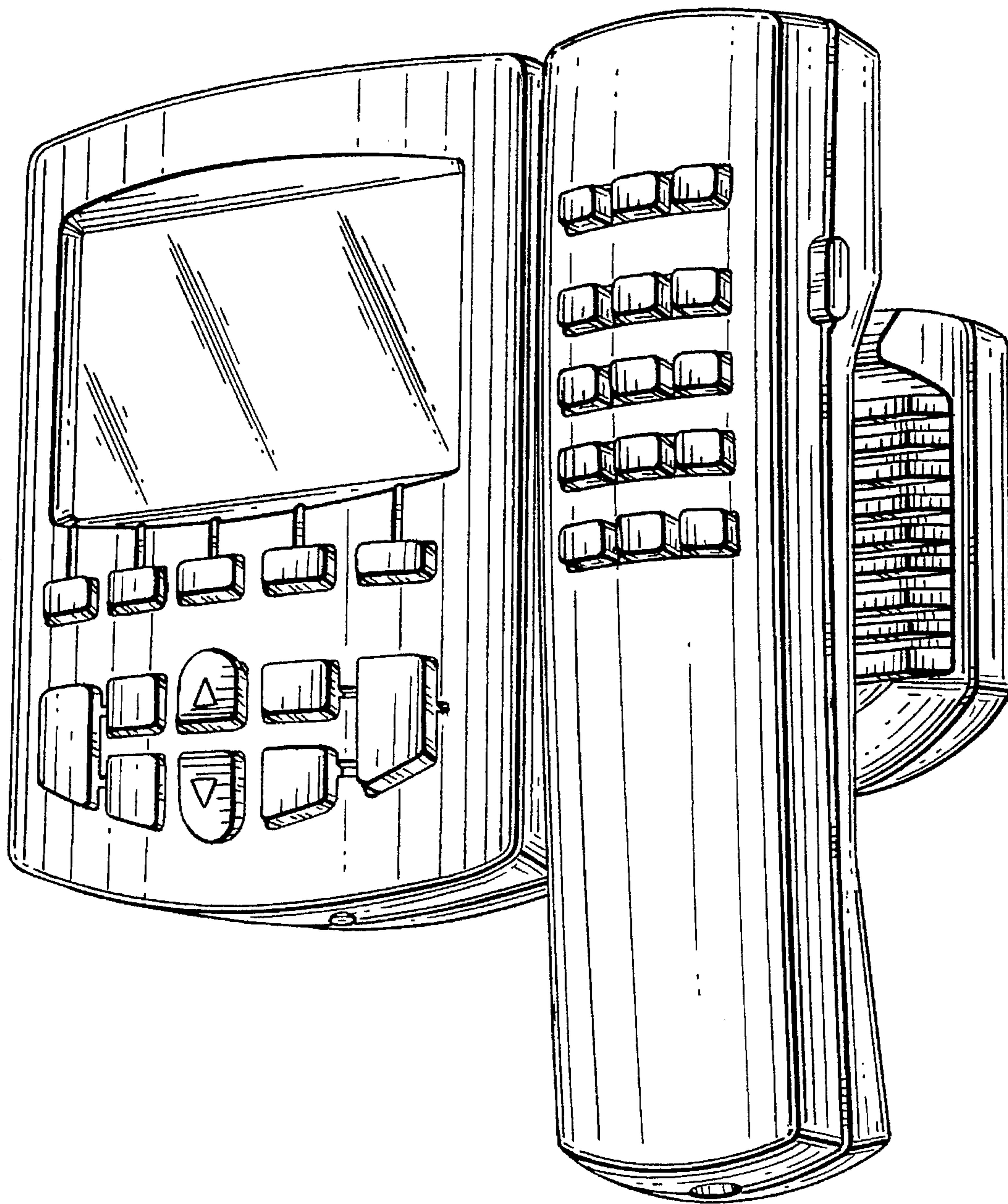



FIG. 2

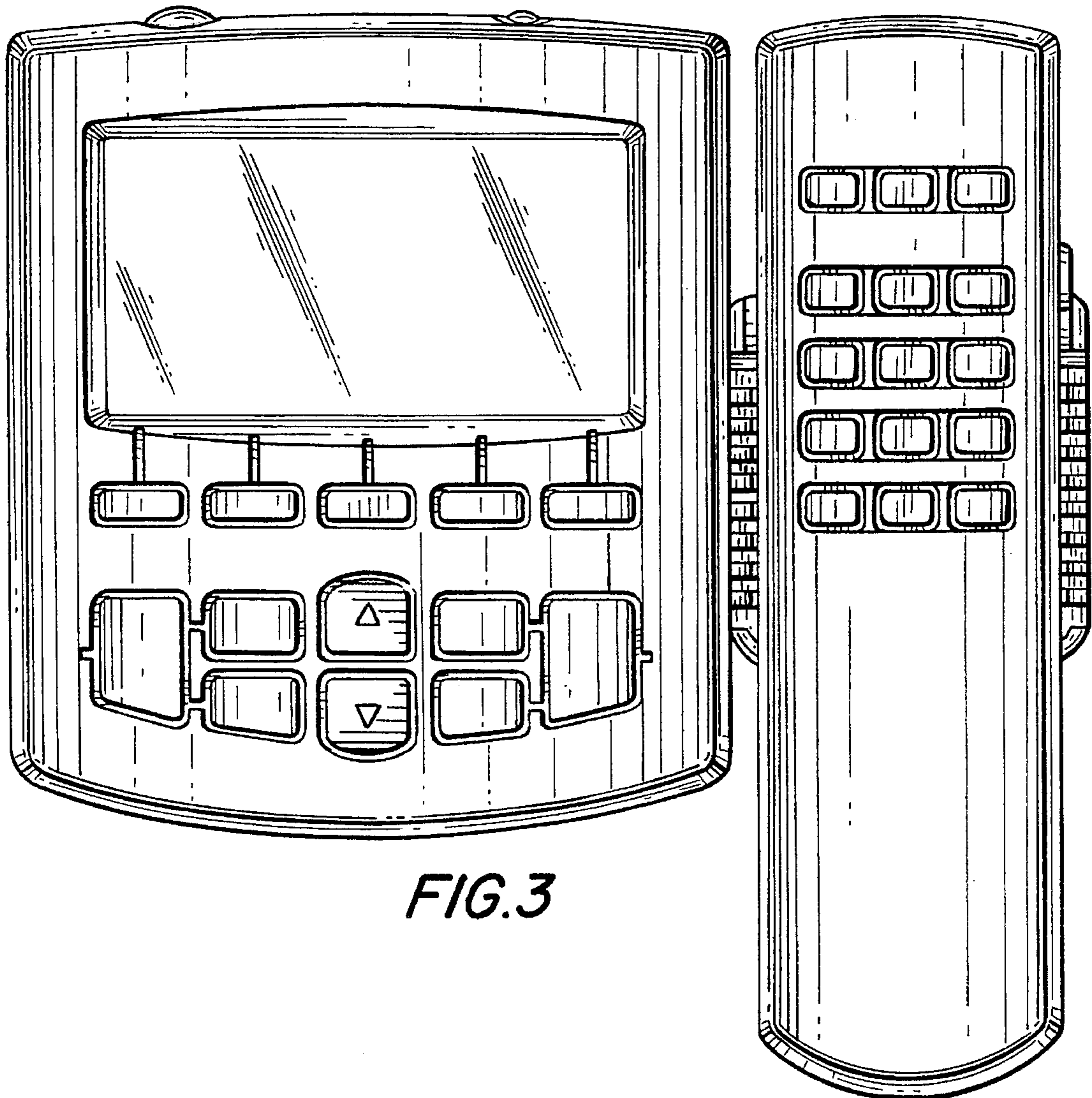
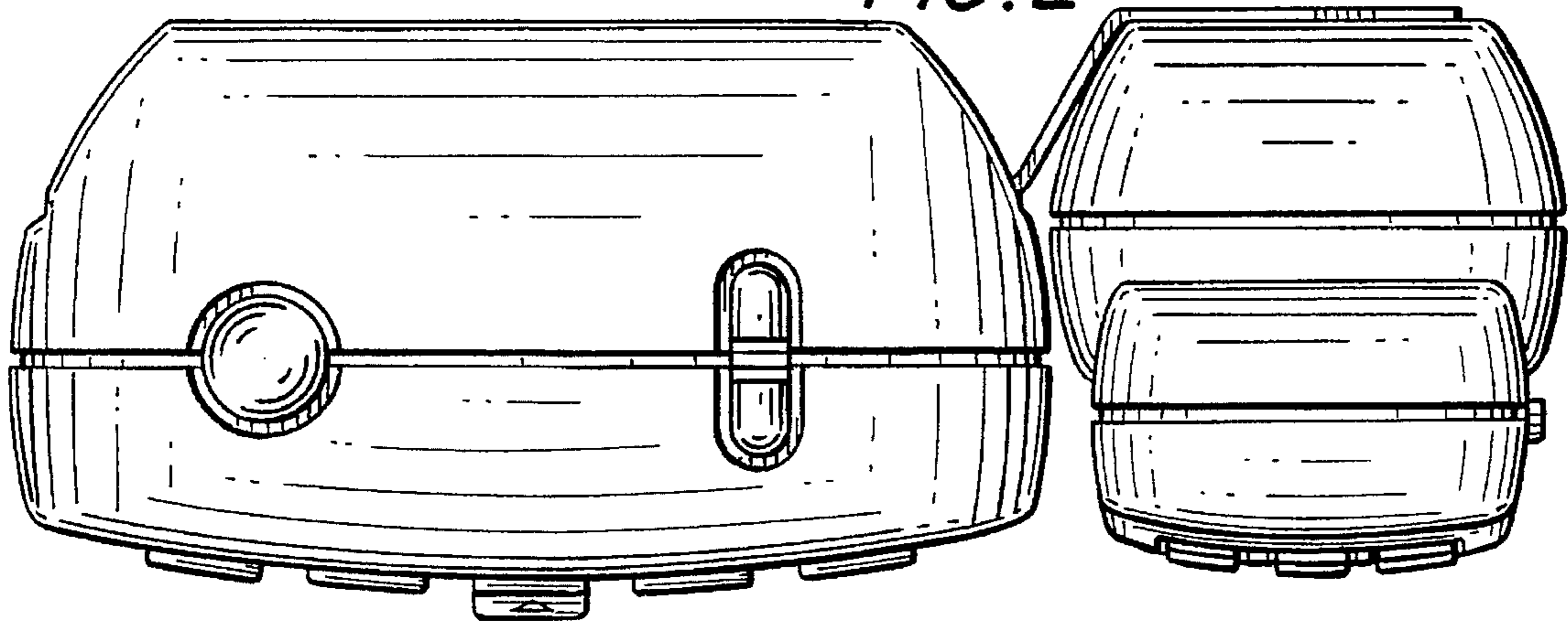
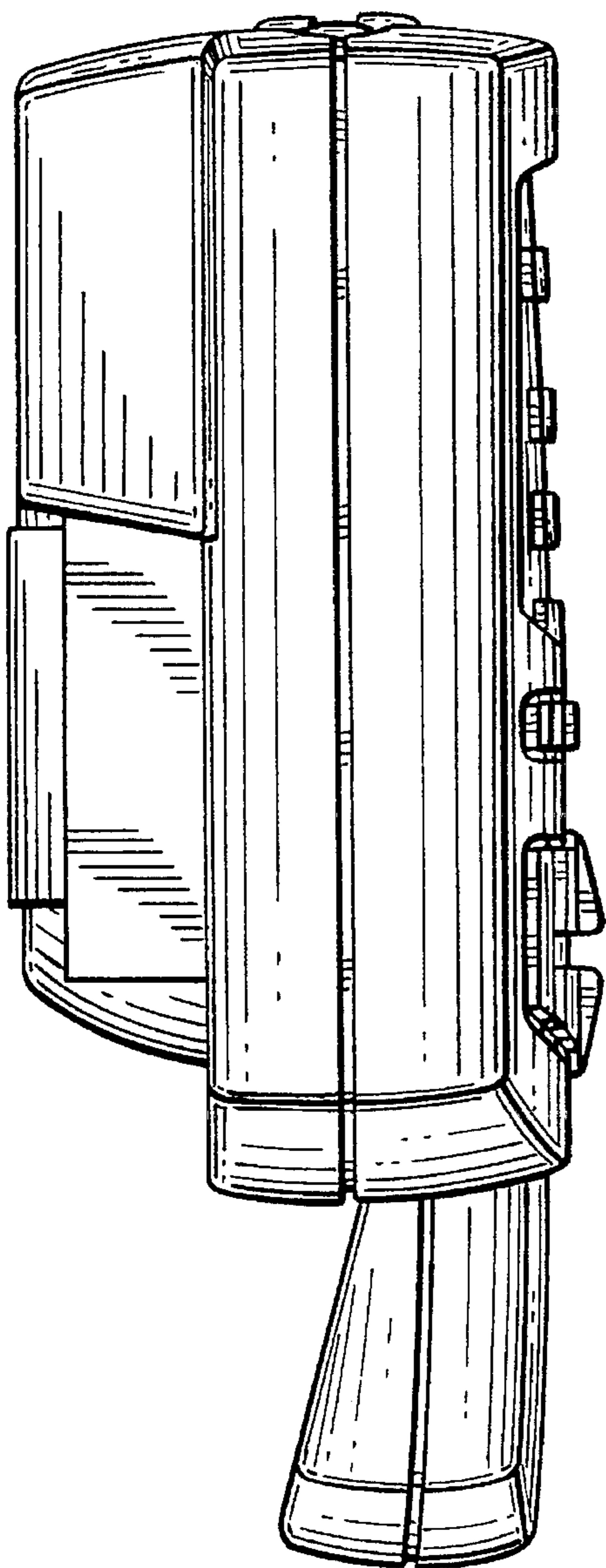
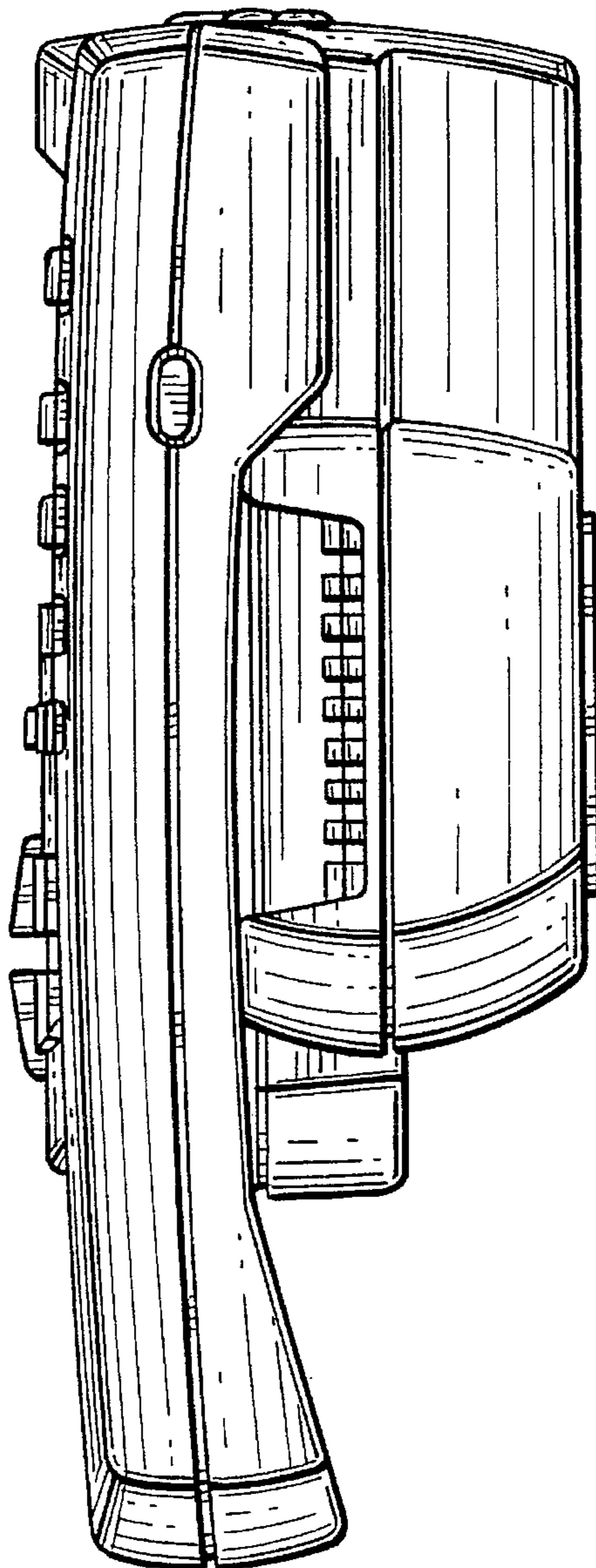

FIG. 3

*FIG. 4*



*FIG. 5*



*FIG. 6*

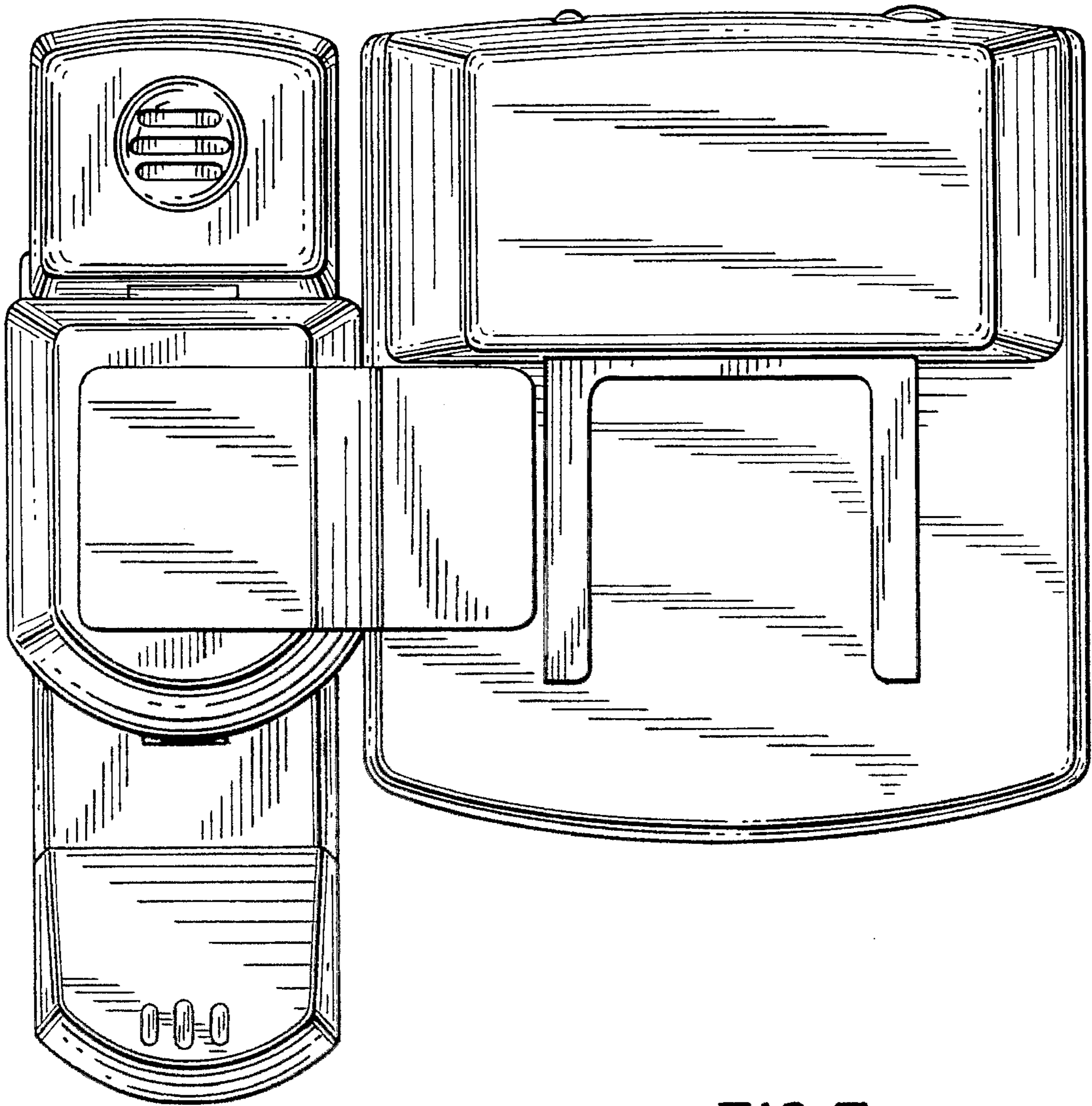

*FIG. 7*

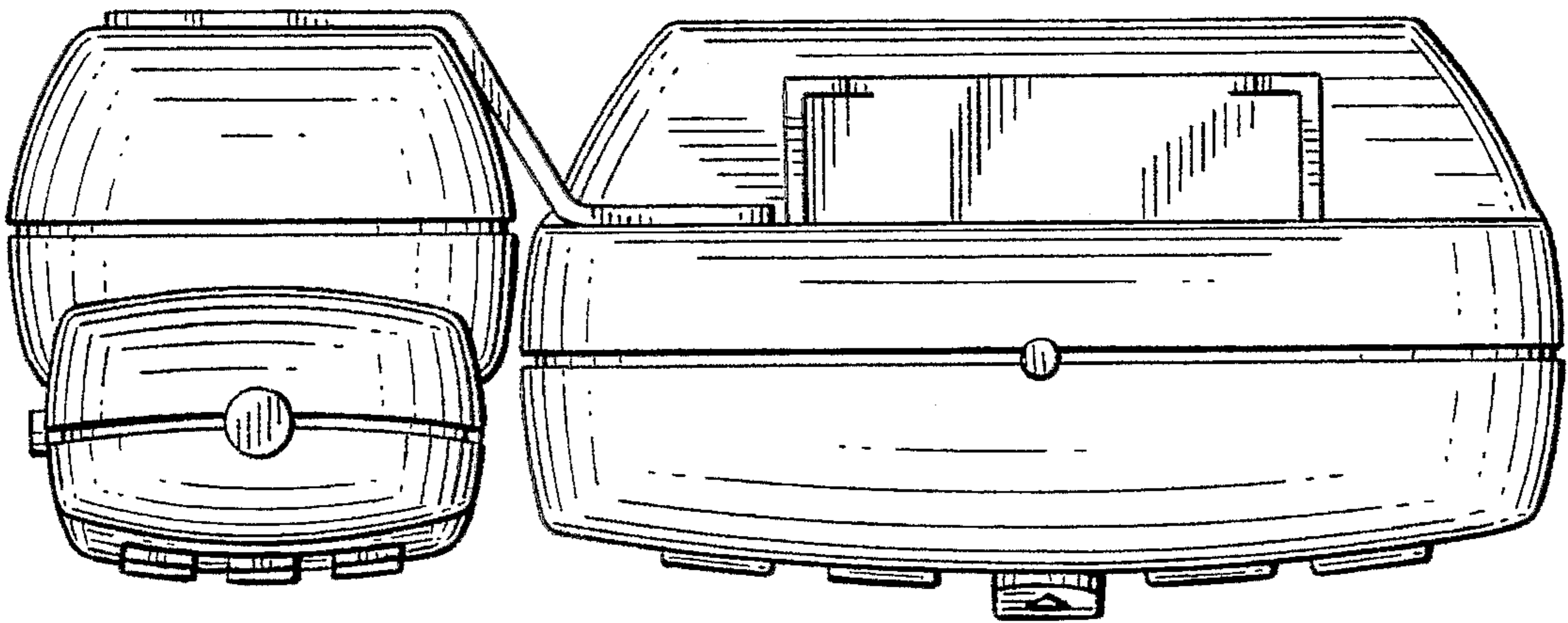



UNITED STATES PATENT AND TRADEMARK OFFICE  
**CERTIFICATE OF CORRECTION**

PATENT NO. : Des. 375,092  
DATED : October 29, 1996  
INVENTOR(S) : Oliver Hilsenrath et al

It is certified that error appears in the above-identified patent and that said Letters Patent is hereby corrected as shown below:

On the cover page for the title at [54] change the word  
**"PORTABLE"** to -- **MOBILE** --.

On the cover page for the Claim at [57] change "portable" to  
-- mobile --.

On the cover page for the DESCRIPTION as concerns the  
description of FIG. 1, change "portable" to -- mobile --.

Signed and Sealed this  
Fifth Day of May, 1998



BRUCE LEHMAN

*Commissioner of Patents and Trademarks*

*Attest:*

*Attesting Officer*