



US00D375048S

United States Patent [19]

[11] Patent Number: **Des. 375,048**

Barrash et al.

[45] Date of Patent: ****Oct. 29, 1996**

[54] **COLLAPSIBLE BOTTLE**

4,351,454 9/1982 Maynard, Jr. 215/384

[75] Inventors: **Marshall Barrash**, Atlanta; **William Credle, Jr.**, Stone Mtn., both of Ga.

4,492,313 1/1985 Touzani .

4,773,458 9/1988 Touzani .

4,901,878 2/1990 Humphries 215/383 X

[73] Assignee: **The Coca-Cola Company**, Atlanta, Ga.

Primary Examiner—Lucy Lieberman

Attorney, Agent, or Firm—Birch, Stewart, Kolasch & Birch, LLP

[**] Term: **14 Years**

[57] CLAIM

[21] Appl. No.: **39,474**

The ornamental design for a collapsible bottle, as shown and described.

[22] Filed: **May 18, 1995**

[52] U.S. Cl. **D9/525; D9/301**

DESCRIPTION

[58] Field of Search D9/525, 520, 526, D9/301, 524, 527, 528, 556, 557; 220/666, 669; 215/383, 384, 382; 222/572, 573; D23/225

FIG. 1 is a top, front, and side perspective view of the collapsible bottle showing our new design;

FIG. 2 is a left side elevational view, the right side elevational view is a mirror image thereto except for the conventional screw threading on the neck;

FIG. 3 is a top plan view of the collapsible bottle of FIG. 1;

FIG. 4 is a bottom plan view of the collapsible bottle of FIG. 1;

FIG. 5 is a front elevational view of the collapsible bottle of FIG. 1;

FIG. 6 is a rear elevational view of the collapsible bottle of FIG. 1; and,

FIG. 7 is a top, front, and side perspective view of the collapsible bottle in a dispensing position.

[56] References Cited

U.S. PATENT DOCUMENTS

D. 199,374	10/1964	Choate	D9/301
D. 200,930	4/1965	Hango	D9/301
D. 252,379	7/1979	Hartung	D9/301
D. 255,873	7/1980	Hustrei	D9/525
D. 272,380	1/1984	Poon	D23/225
D. 274,699	7/1984	Epperson	D9/520
D. 278,799	5/1985	Maynard, Jr.	D9/528
D. 284,885	7/1986	Nakamura	D23/225
D. 289,976	5/1987	Humphries	D9/527 X
3,964,689	6/1976	Horvath, Jr.	D23/225 X

1 Claim, 4 Drawing Sheets

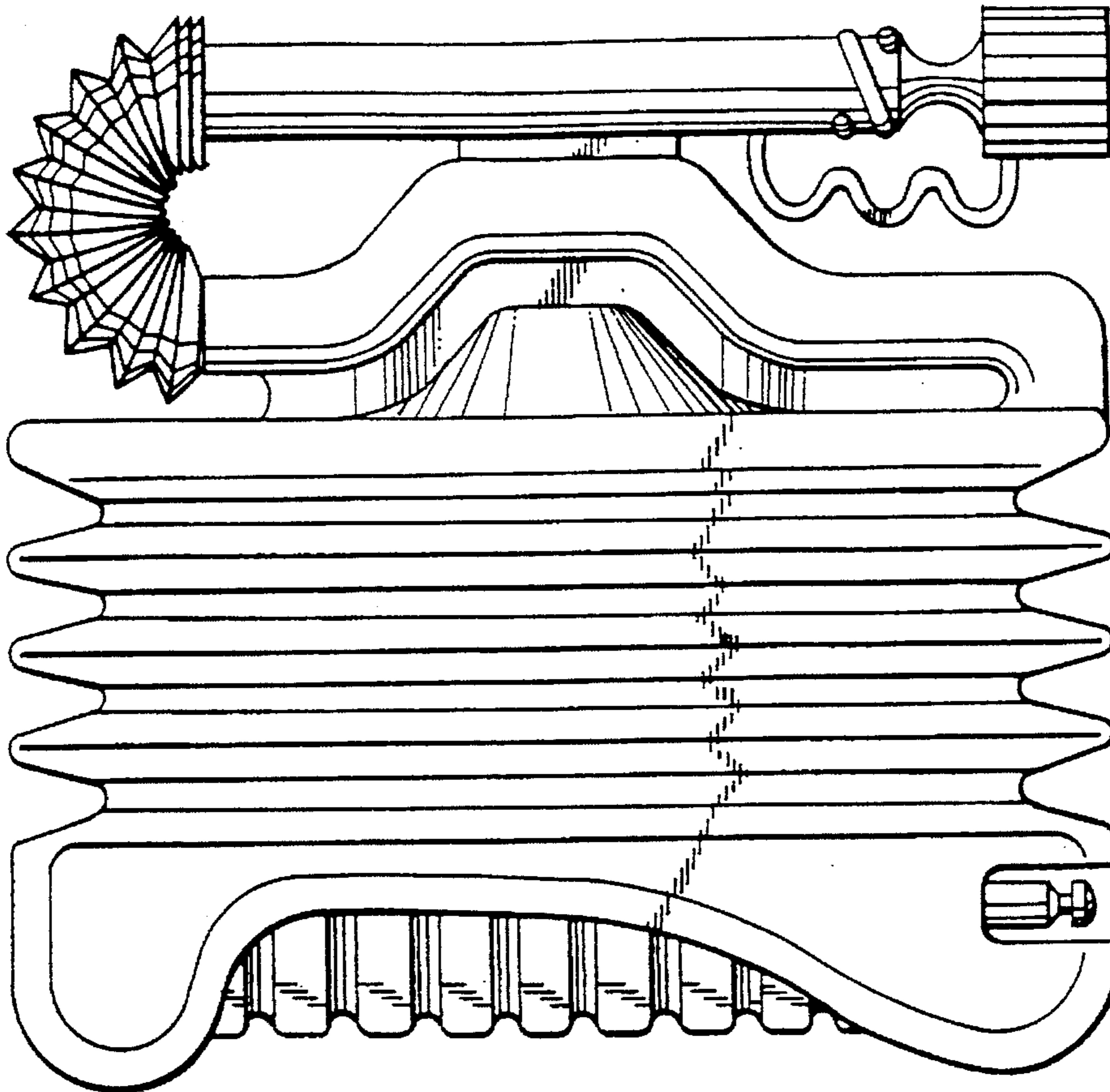

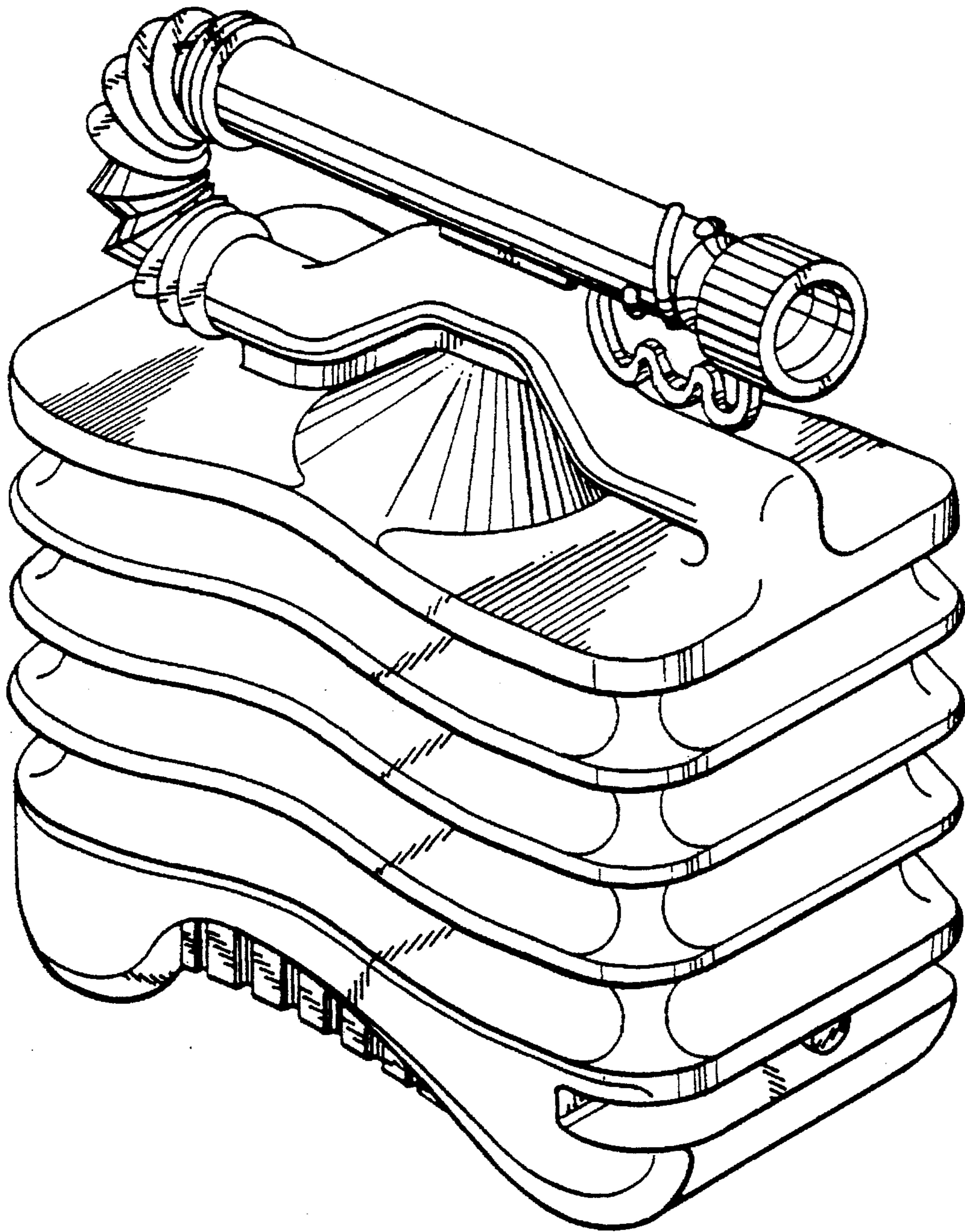

FIG 1

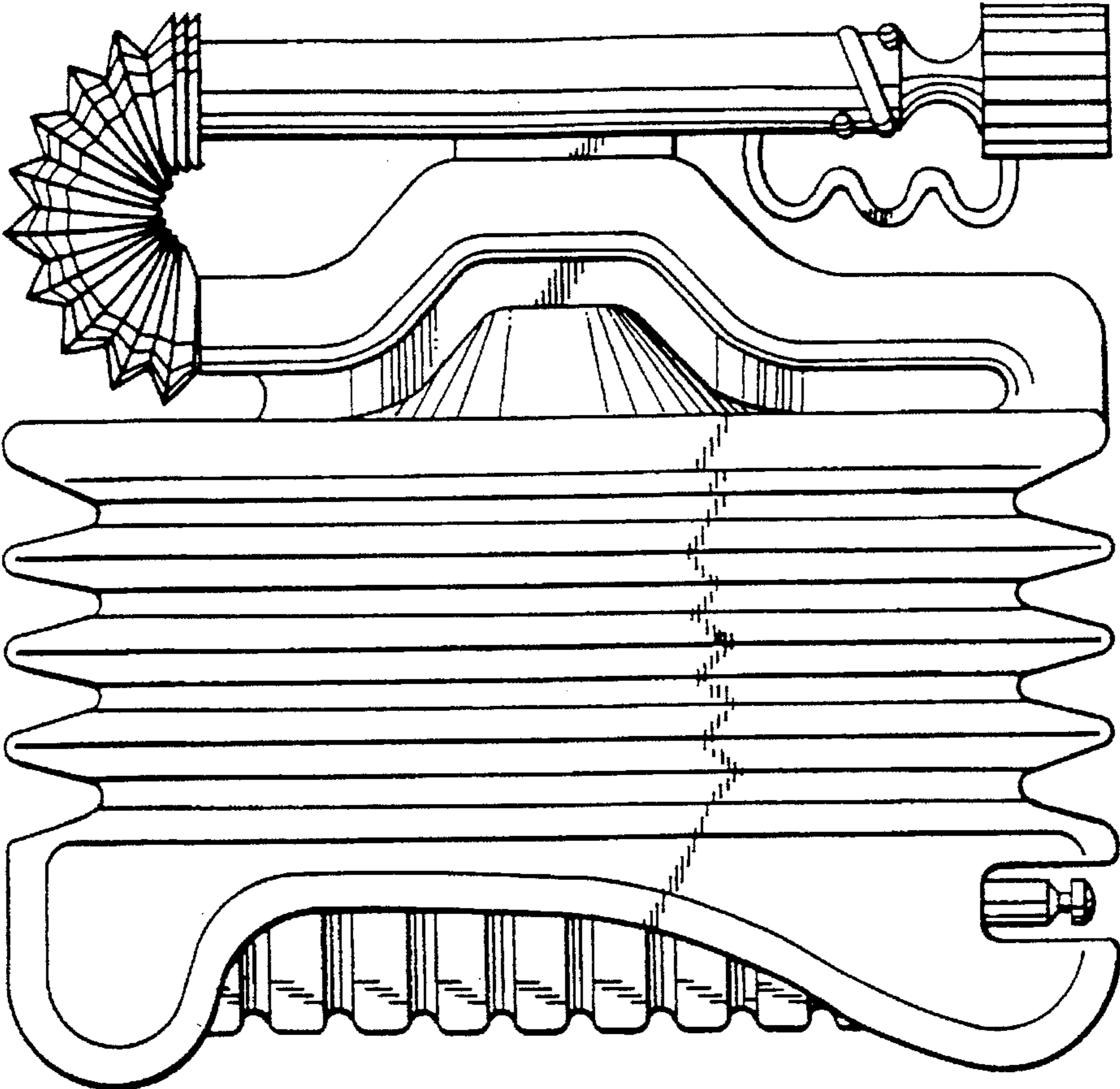

FIG 2

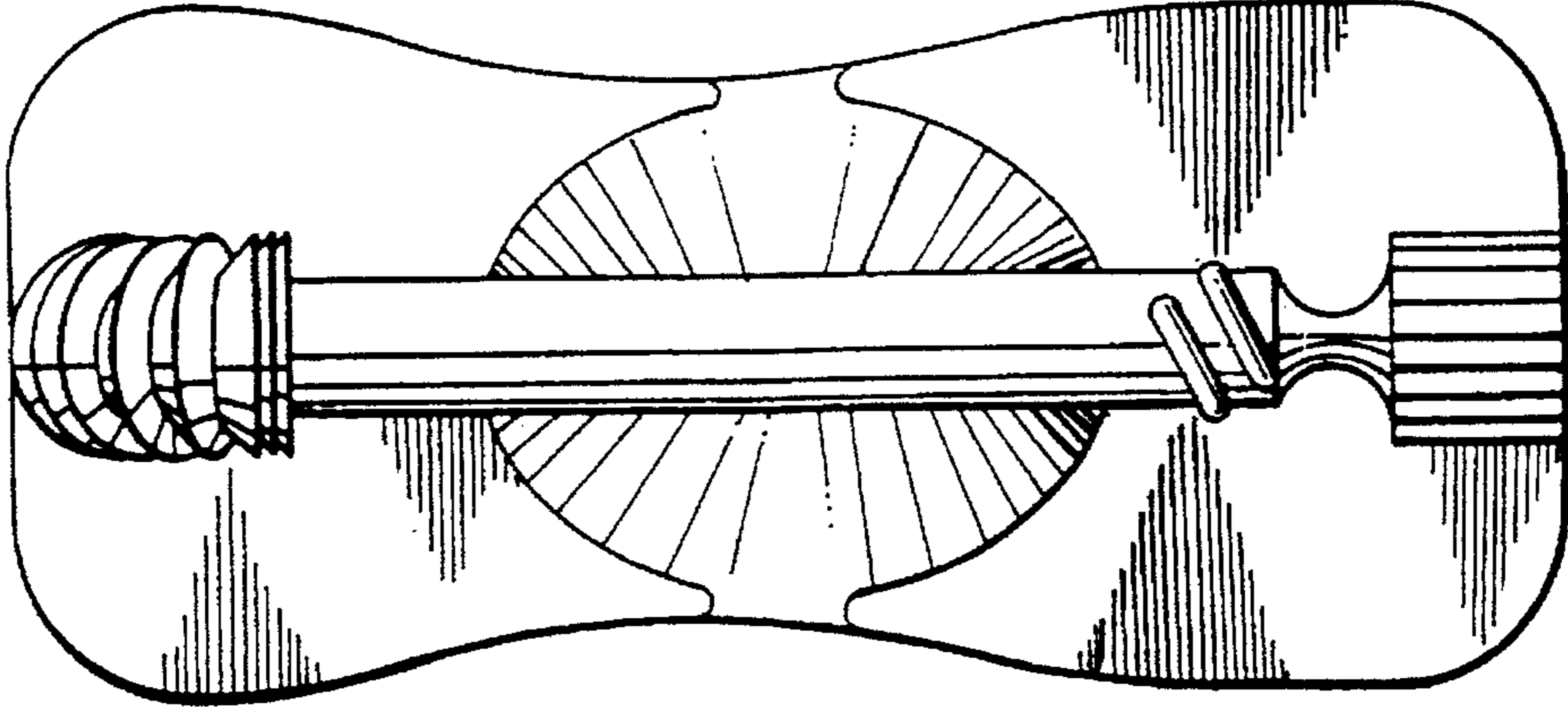

FIG 3

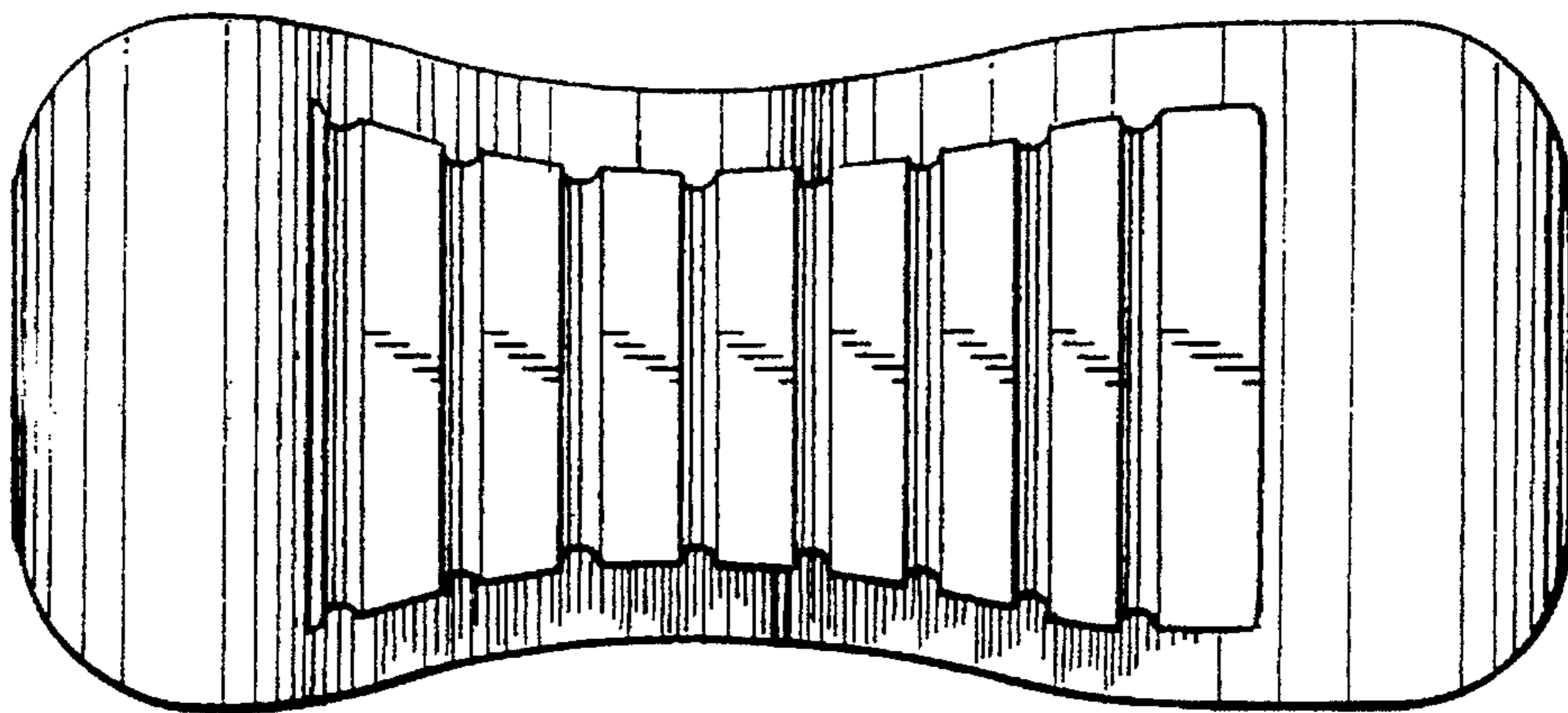

FIG 4

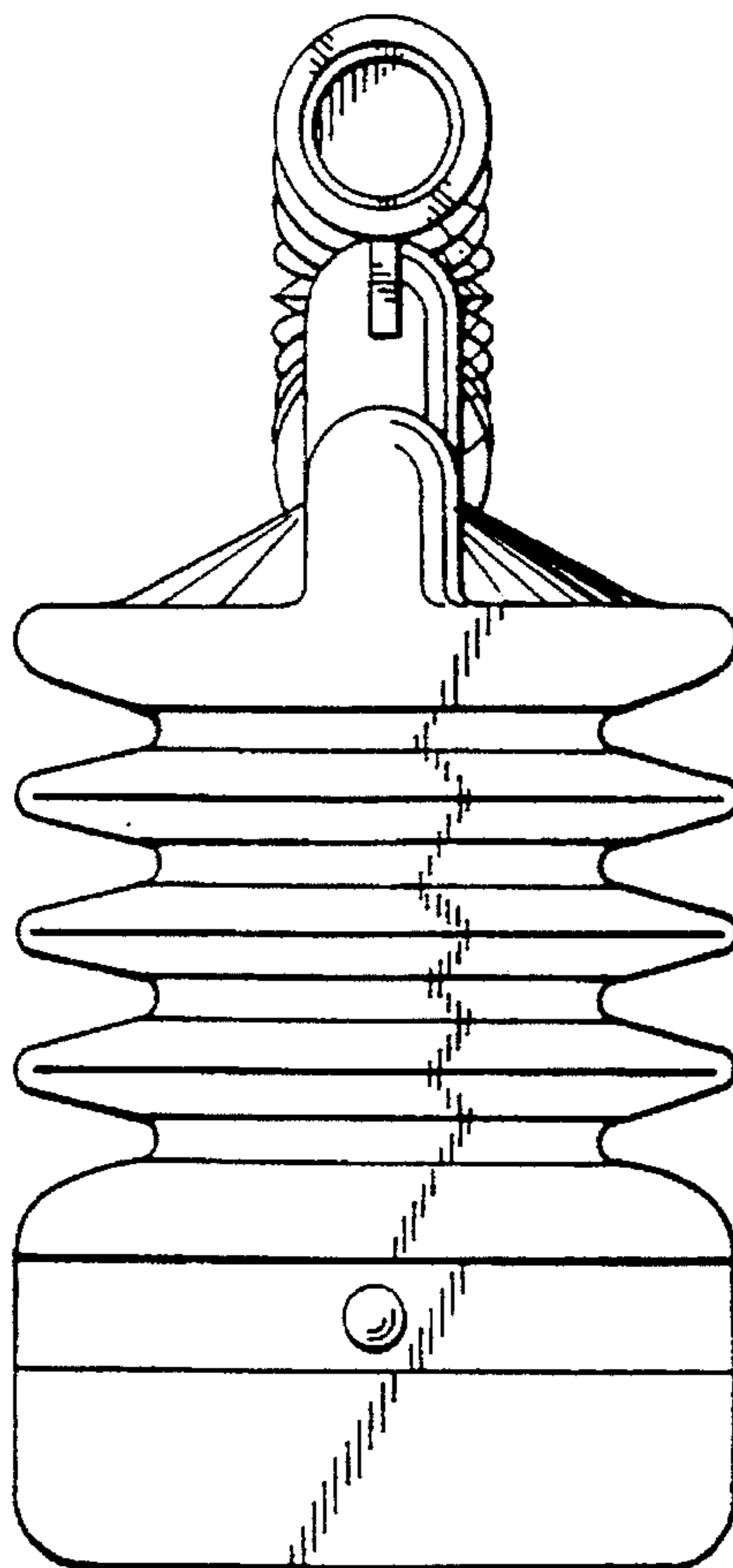

FIG 5

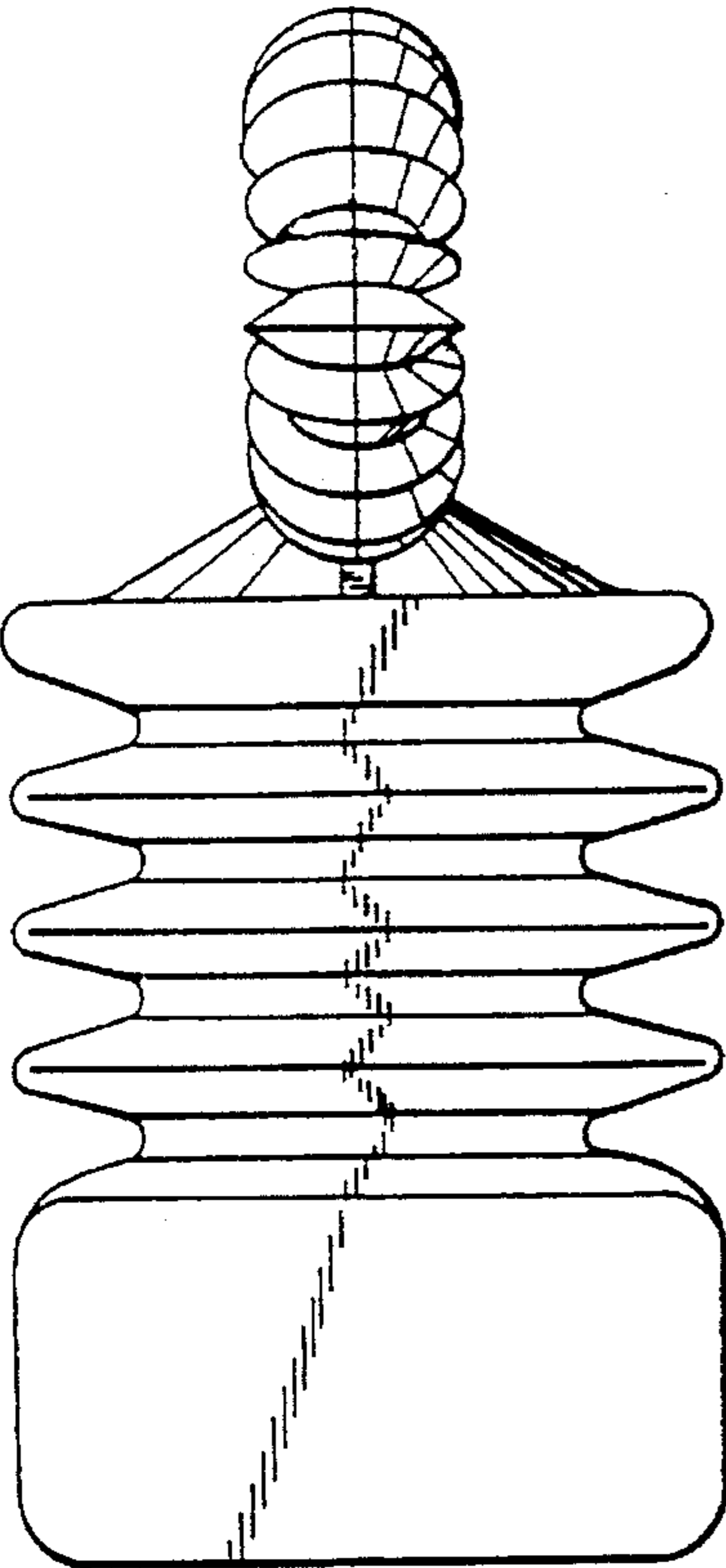

FIG 6

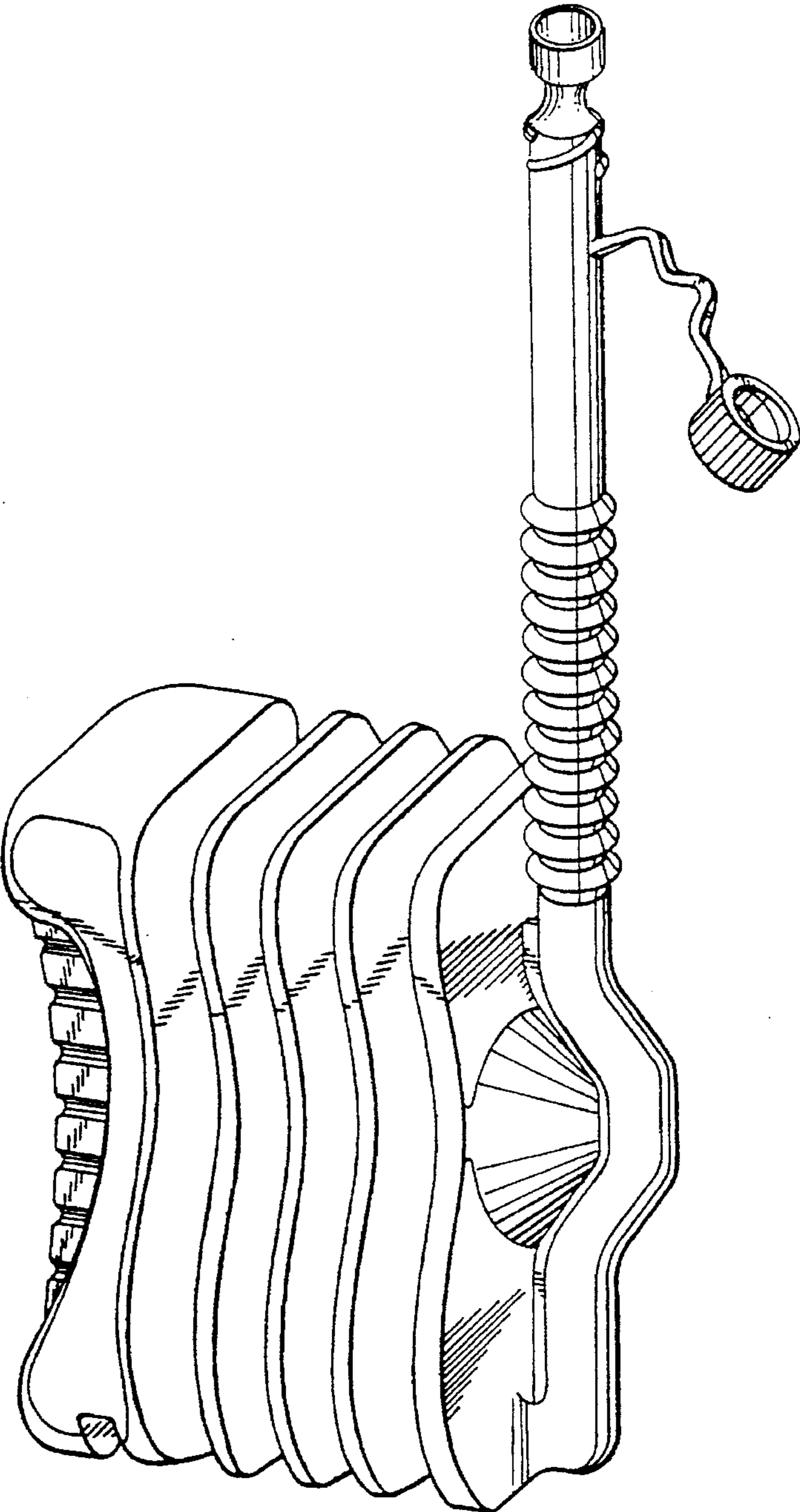

FIG 7