



US00D374953S

United States Patent [19]

Wareham et al.

[11] Patent Number: **Des. 374,953**

[45] Date of Patent: ****Oct. 22, 1996**

[54] VACUUM CLEANER TOP CONSOLE

[75] Inventors: **Richard A. Wareham**, North Canton;
Ronald J. Stephens, Rittman, both of Ohio

[73] Assignee: **The Hoover Company**, North Canton, Ohio

[**] Term: **14 Years**

[21] Appl. No.: **42,375**

[22] Filed: **Aug. 9, 1995**

[52] U.S. Cl. **D32/31**

[58] Field of Search D32/21, 22, 31-34;
15/320, 322, 323, 347, 350, 351-353

[56] References Cited

U.S. PATENT DOCUMENTS

D. 314,847	2/1991	Shouji et al.	D32/22
D. 325,657	4/1992	Brewin	D32/22
D. 335,556	5/1993	Kuriya	D32/22
D. 354,379	1/1995	Shinozaki	D32/22
D. 357,096	4/1995	Wareham	D32/31
D. 358,236	5/1995	Kopco et al.	D32/22
D. 361,181	8/1995	Wareham et al.	D32/31

OTHER PUBLICATIONS

Photo Panasonic Model MC-E417.
Photo Panasonic Model MC-6855.

Primary Examiner—Ruth McInroy

Attorney, Agent, or Firm—A. Burgess Lowe; Richardson B. Farley

[57] CLAIM

The ornamental design of a vacuum cleaner top console, as shown and described.

DESCRIPTION

FIG. 1 is a top view of a vacuum cleaner top console showing our new design;
FIG. 2 is a front elevational view thereof;
FIG. 3 is a bottom view thereof;
FIG. 4 is a left end view thereof;
FIG. 5 is a right end view thereof;
FIG. 6 is a rear elevational view thereof; and,
FIG. 7 is a front elevational view thereof with the dashed representation found therein representing only environment and forming no part of the claimed design.

1 Claim, 2 Drawing Sheets

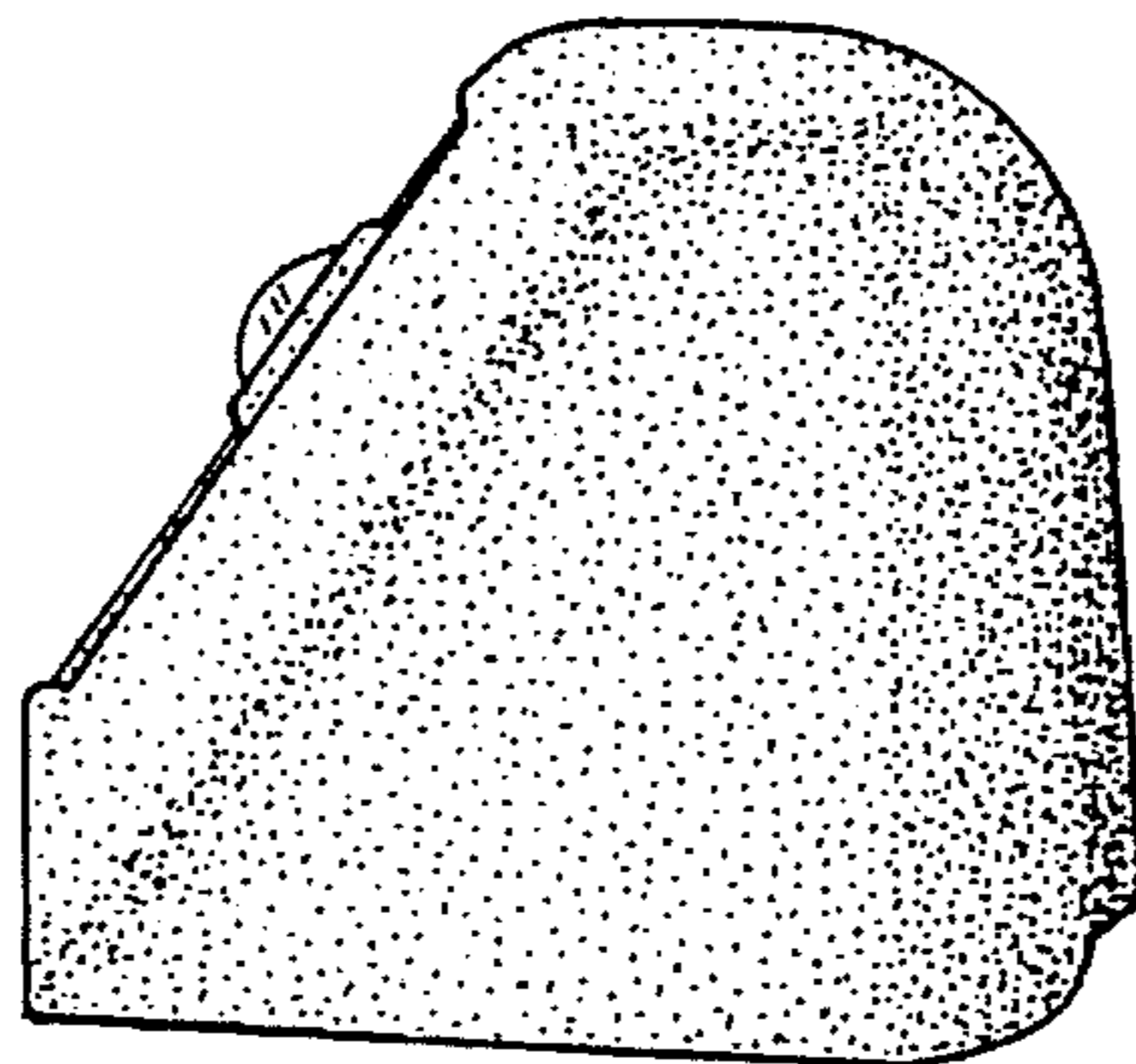
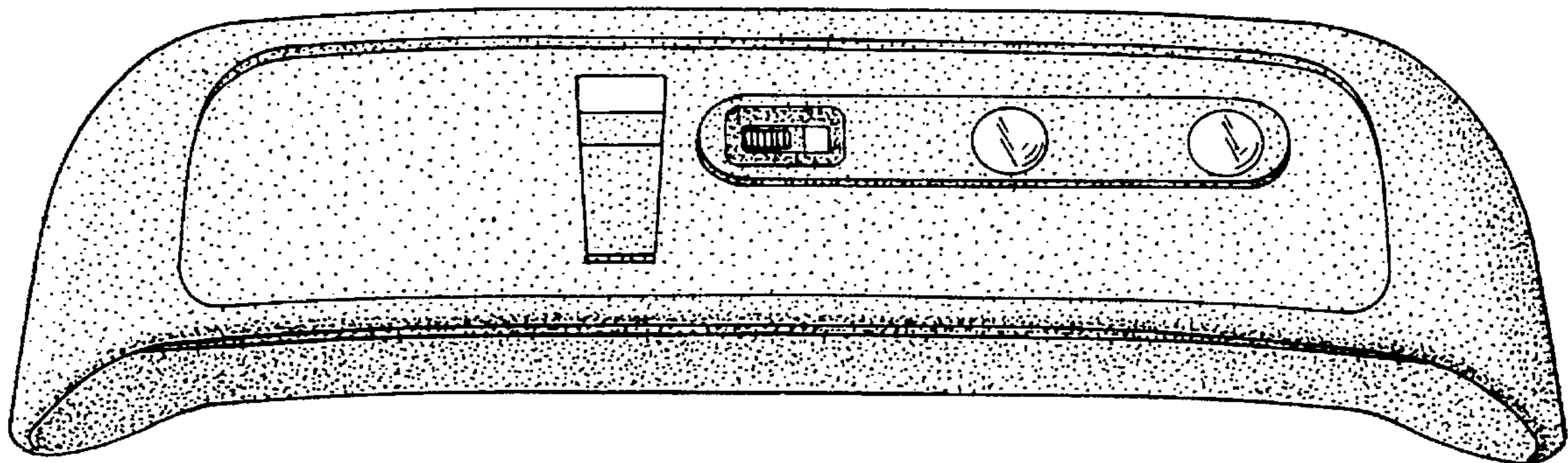

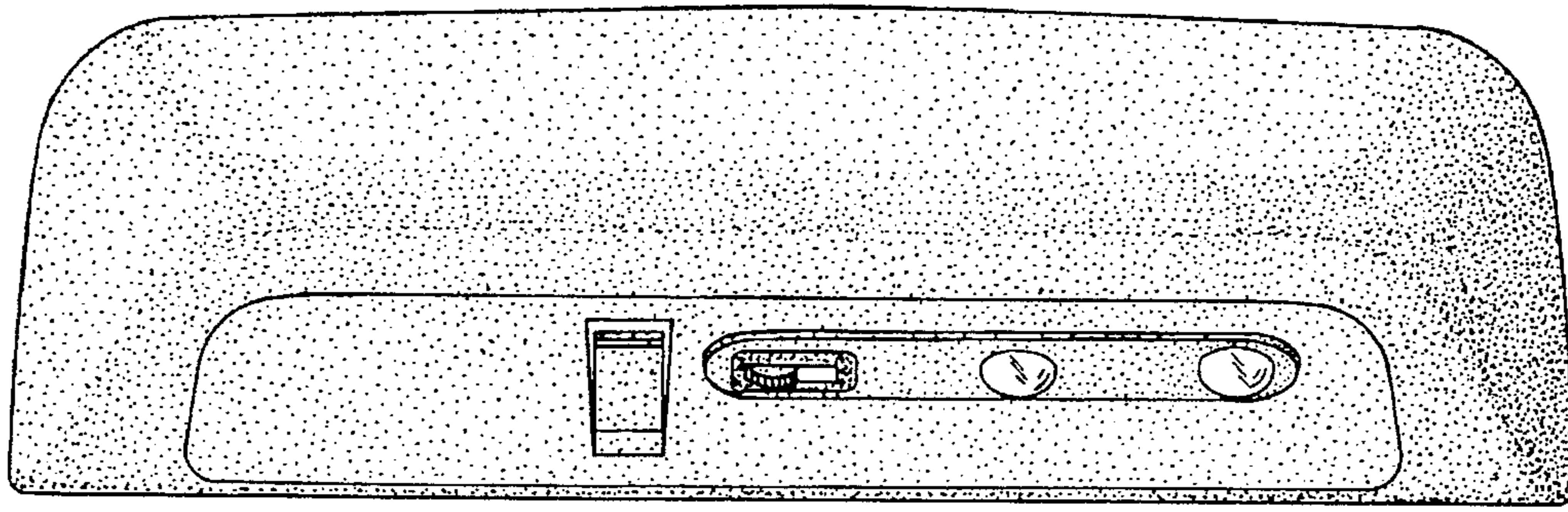

FIG. - 1

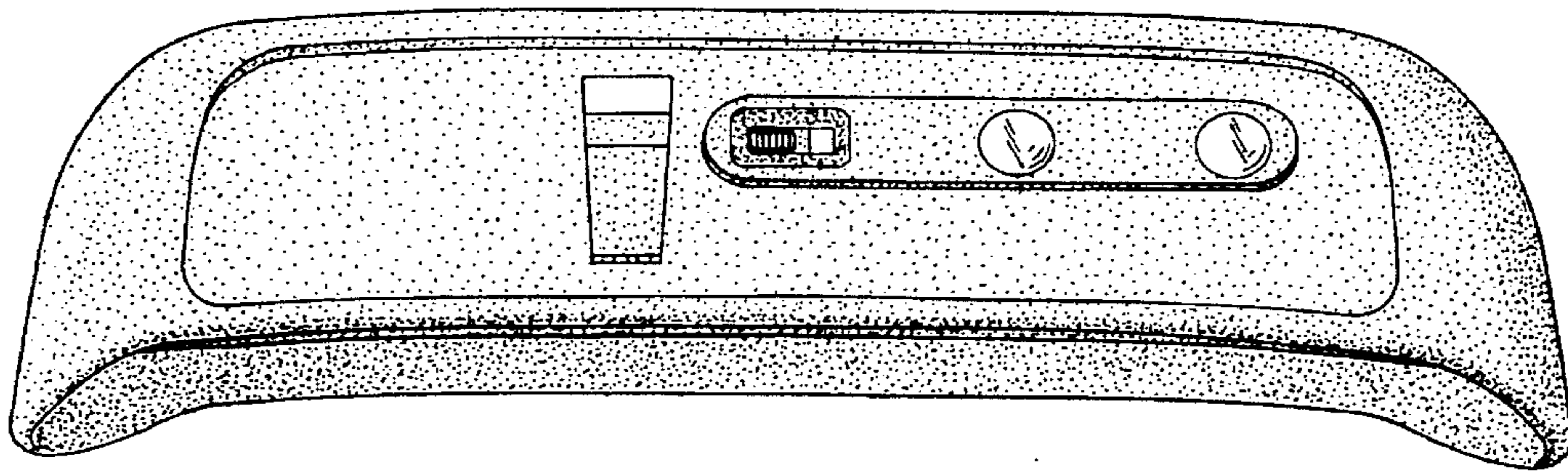

FIG. - 2

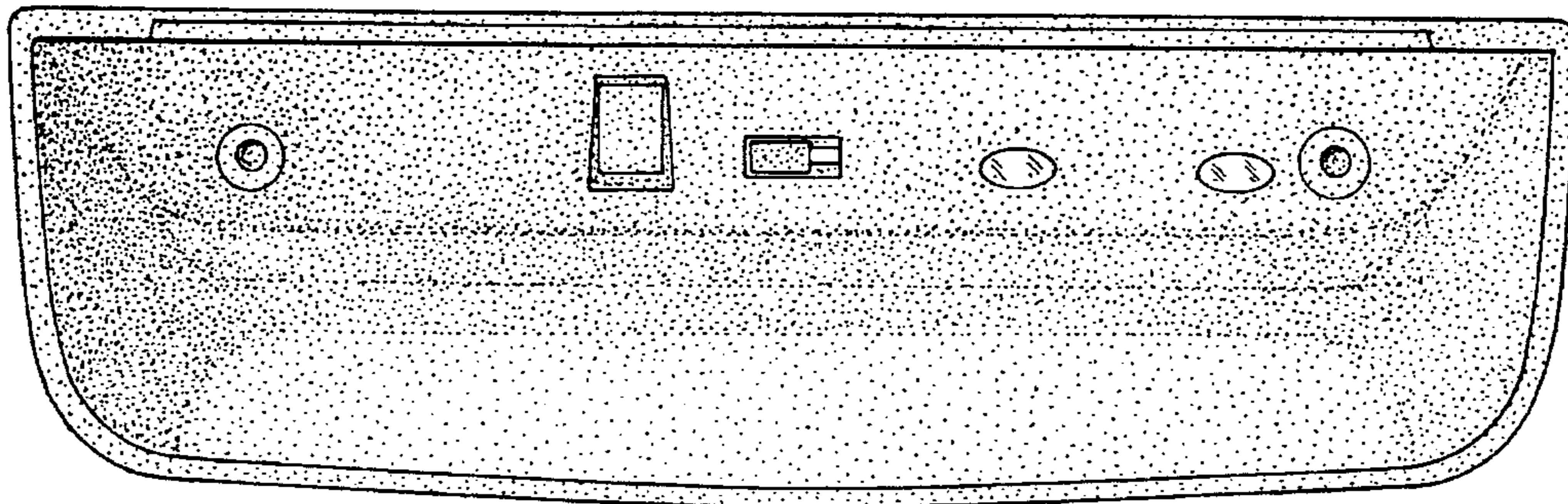

FIG. - 3

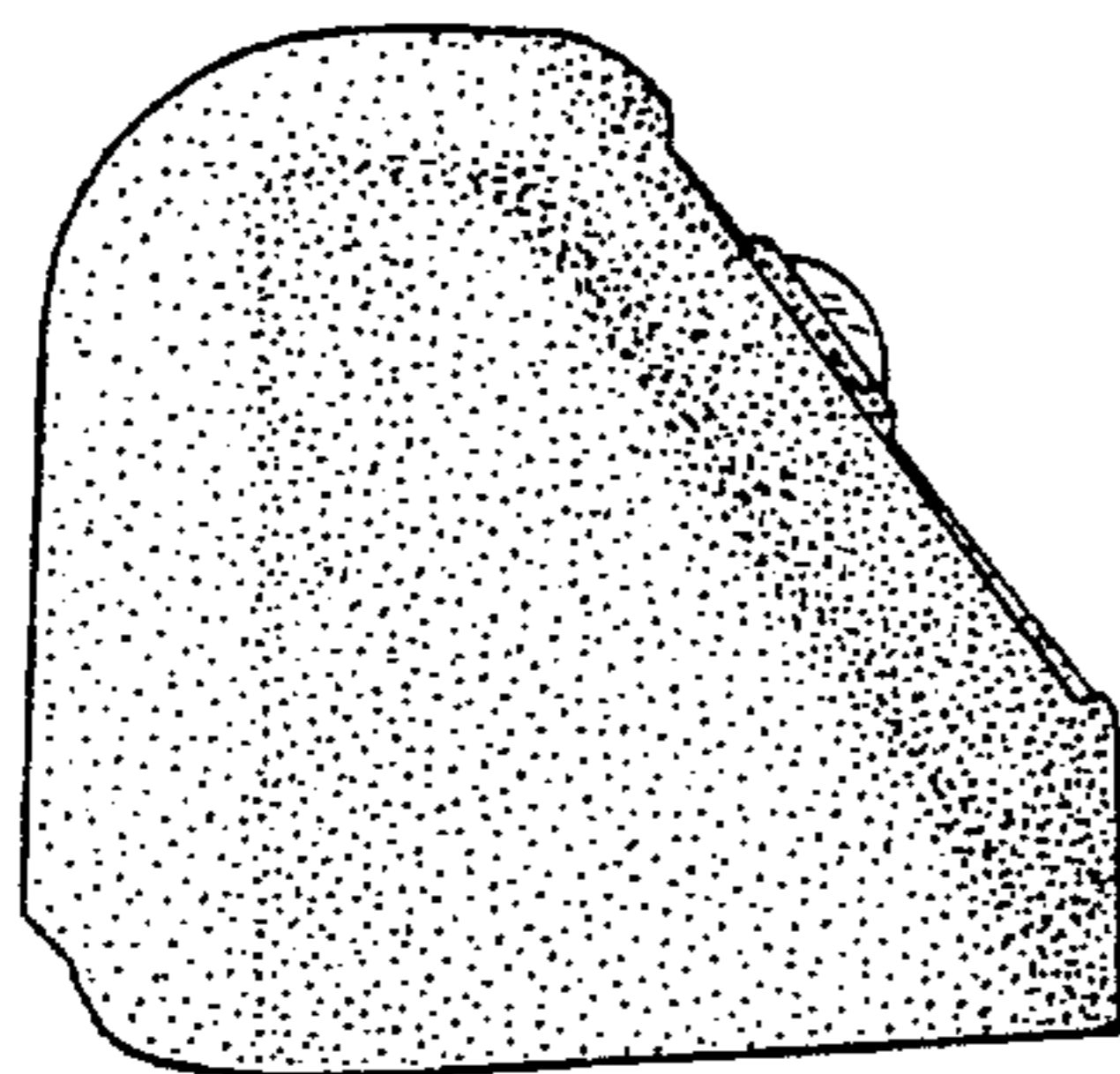

FIG. - 4

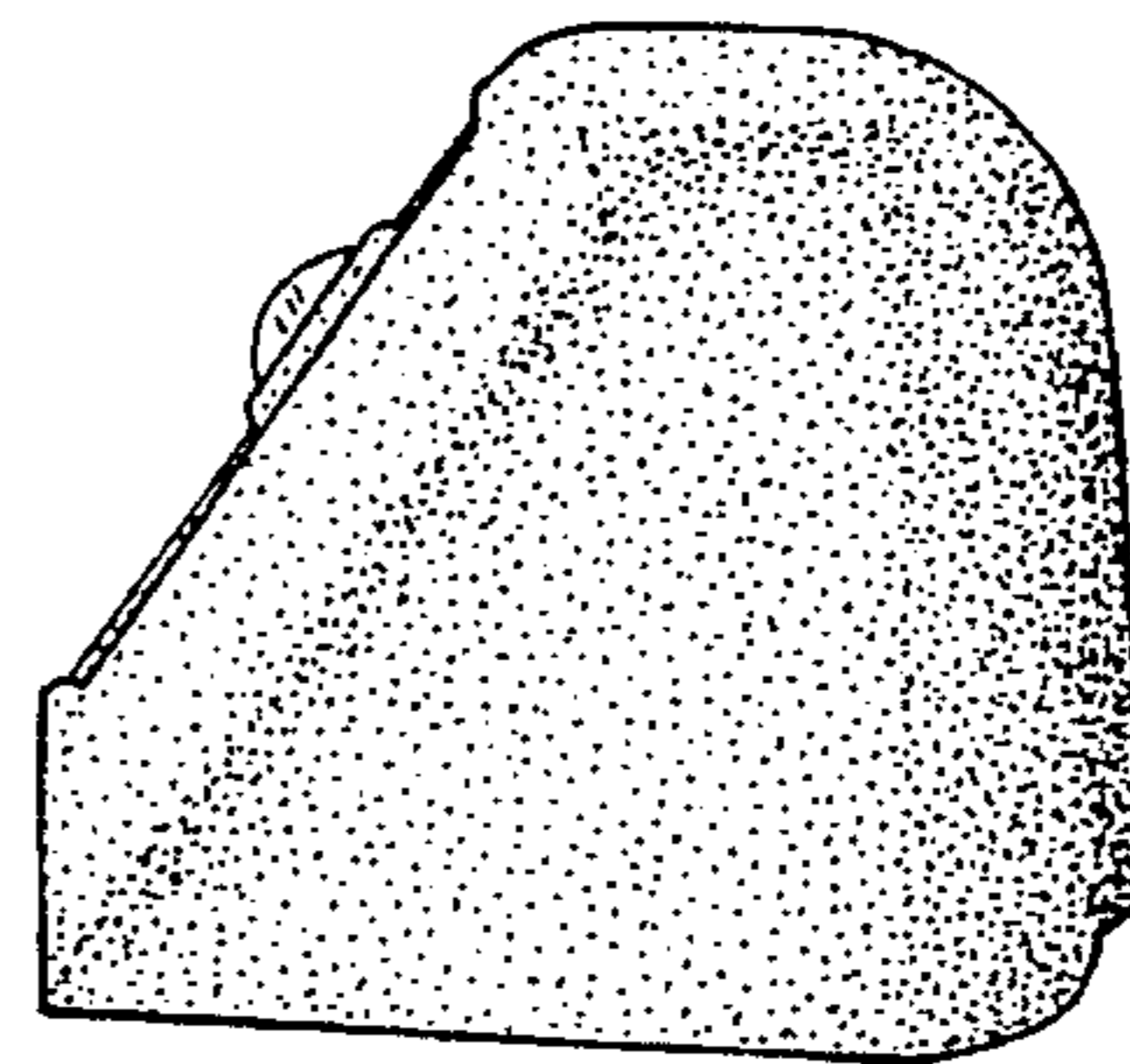

FIG. - 5

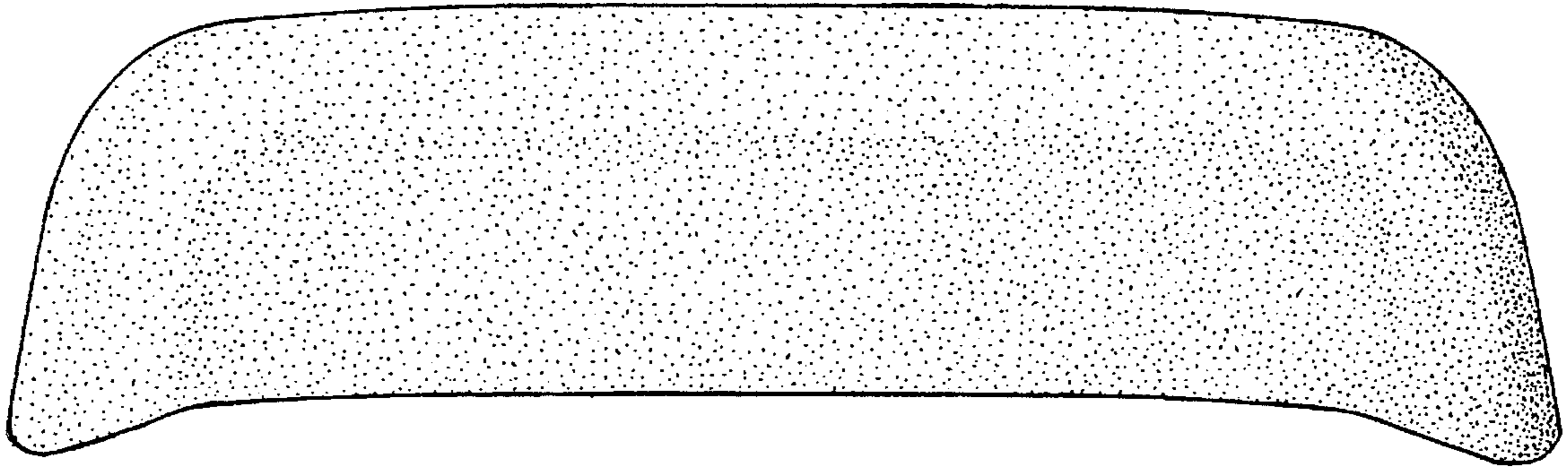
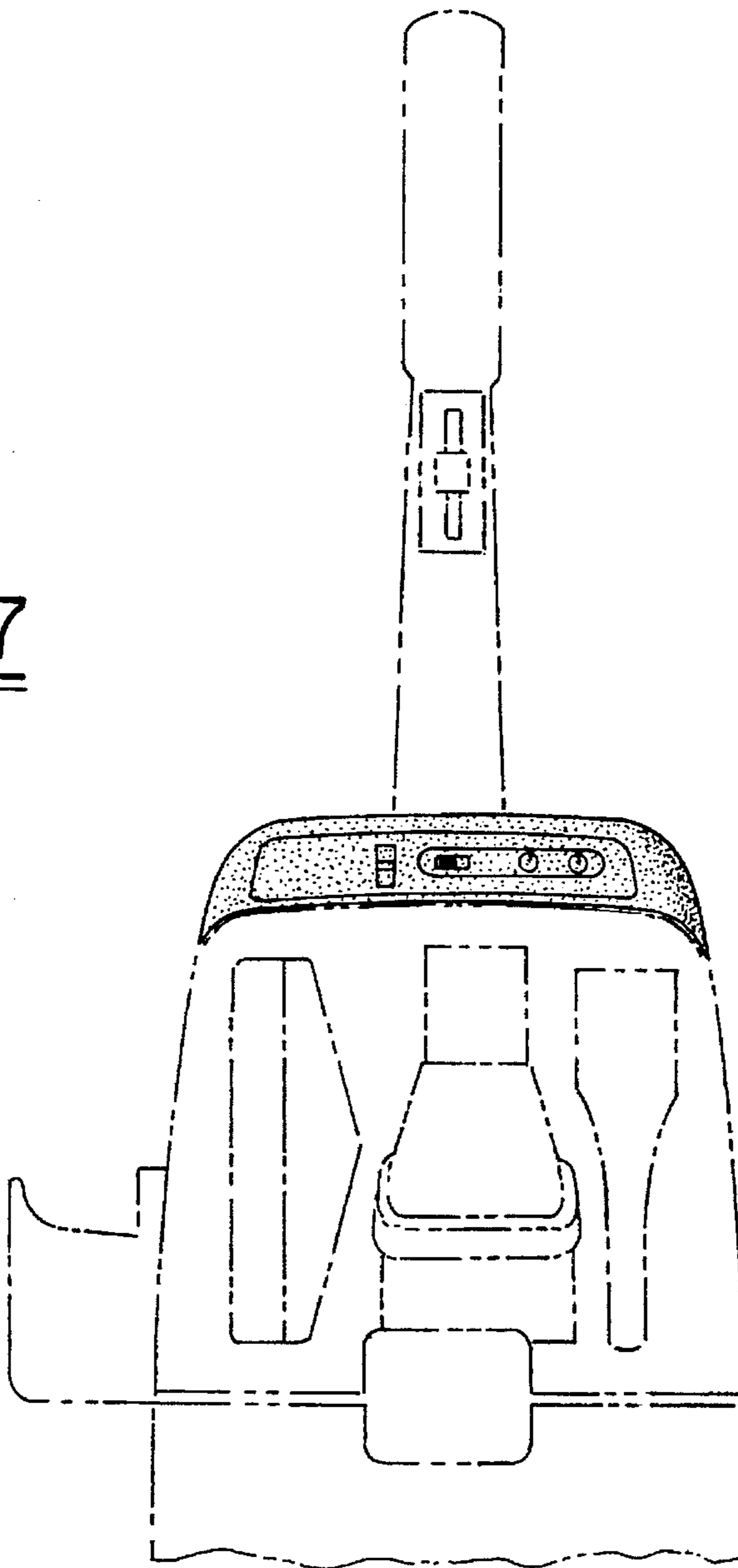

FIG.-6

FIG.-7



UNITED STATES PATENT AND TRADEMARK OFFICE
CERTIFICATE OF CORRECTION

PATENT NO. : Des. 374,953

DATED : October 22, 1996

INVENTOR(S) : Richard A. Wareham and Ronald J. Stephens

It is certified that error appears in the above-identified patent and that said Letters Patent is hereby corrected as shown below:

TITLE PAGE, ITEM [75]:

The Inventors' listing should read: Richard A. Wareham, North Canton; Ronald J. Stephens, Rittman; Lynn A. Frederick, Brady Lake, all of Ohio

Signed and Sealed this
Fifteenth Day of April, 1997

Attest:



BRUCE LEHMAN

Attesting Officer

Commissioner of Patents and Trademarks