



US00D374843S

United States Patent [19]

[11] Patent Number: **Des. 374,843**

Attanasio

[45] Date of Patent: ****Oct. 22, 1996**

[54] **COMBINED PLANTER AND LAMP BASE**

2651662 3/1991 France 47/66 C

[76] Inventor: **Lee Attanasio**, P.O. Box 1114, New York, N.Y. 10023

OTHER PUBLICATIONS

"Solid Brass, Murray Feiss Import Corp. Catalog", Jan. 1988, PL58, ST5 Lamp Base.

[**] Term: **14 Years**

Primary Examiner—James M. Gandy
Assistant Examiner—Cathron B. Matta
Attorney, Agent, or Firm—Kane, Dalsimer, Sullivan, Kurucz, Levy, Eisele and Richard, LLP

[21] Appl. No.: **41,450**

[22] Filed: **Jul. 14, 1995**

[52] U.S. Cl. **D11/144; D26/55**

[58] Field of Search D11/144, 153, D11/154; D26/55; 47/66 R, 66 C, 72

[57] CLAIM

The ornamental design for a combined planter and lamp base, as shown and described.

[56] References Cited

U.S. PATENT DOCUMENTS

D. 148,905	3/1948	Bextel .	
D. 170,128	8/1953	Levy	D26/55
D. 242,941	1/1977	Nagata .	
D. 278,521	4/1985	Baird et al.	D11/153
1,419,152	6/1922	Lansing et al. .	
1,683,271	9/1928	Thompson .	
1,896,229	2/1933	Ellis	47/66 R
2,159,302	5/1939	Rab et al.	47/72
3,898,766	8/1975	Goldstaub .	
3,950,637	4/1976	Rodin .	
4,034,508	7/1977	Dedolph .	
4,224,764	9/1980	Dziewulski et al. .	
4,236,353	12/1980	Sorenson .	
4,612,726	9/1986	Mori .	
4,788,792	12/1988	Womick .	
4,803,806	2/1989	Ito .	
5,155,934	10/1992	Leider .	

DESCRIPTION

FIG. 1 is a side perspective view of the combined planter and lamp base showing my new design;
FIG. 2 is a side elevational view thereof with flowers and plants shown in phantom with the opposite side being a mirror image thereof;
FIG. 3 is a top plan view thereof;
FIG. 4 is a bottom plan view thereof;
FIG. 5 is a elevational view of the planter rotated 90° degrees with respect to the view shown in FIG. 2; and,
FIG. 6 is an exploded view of the combined planter and lamp base with the remaining planter portions not shown for ease of illustration.
The broken line showing of a lamp shade, grow lights flowers and plants and electrical wire is for illustration purposes only and forms no part of the claimed design.

FOREIGN PATENT DOCUMENTS

2528662 6/1982 France .

1 Claim, 6 Drawing Sheets

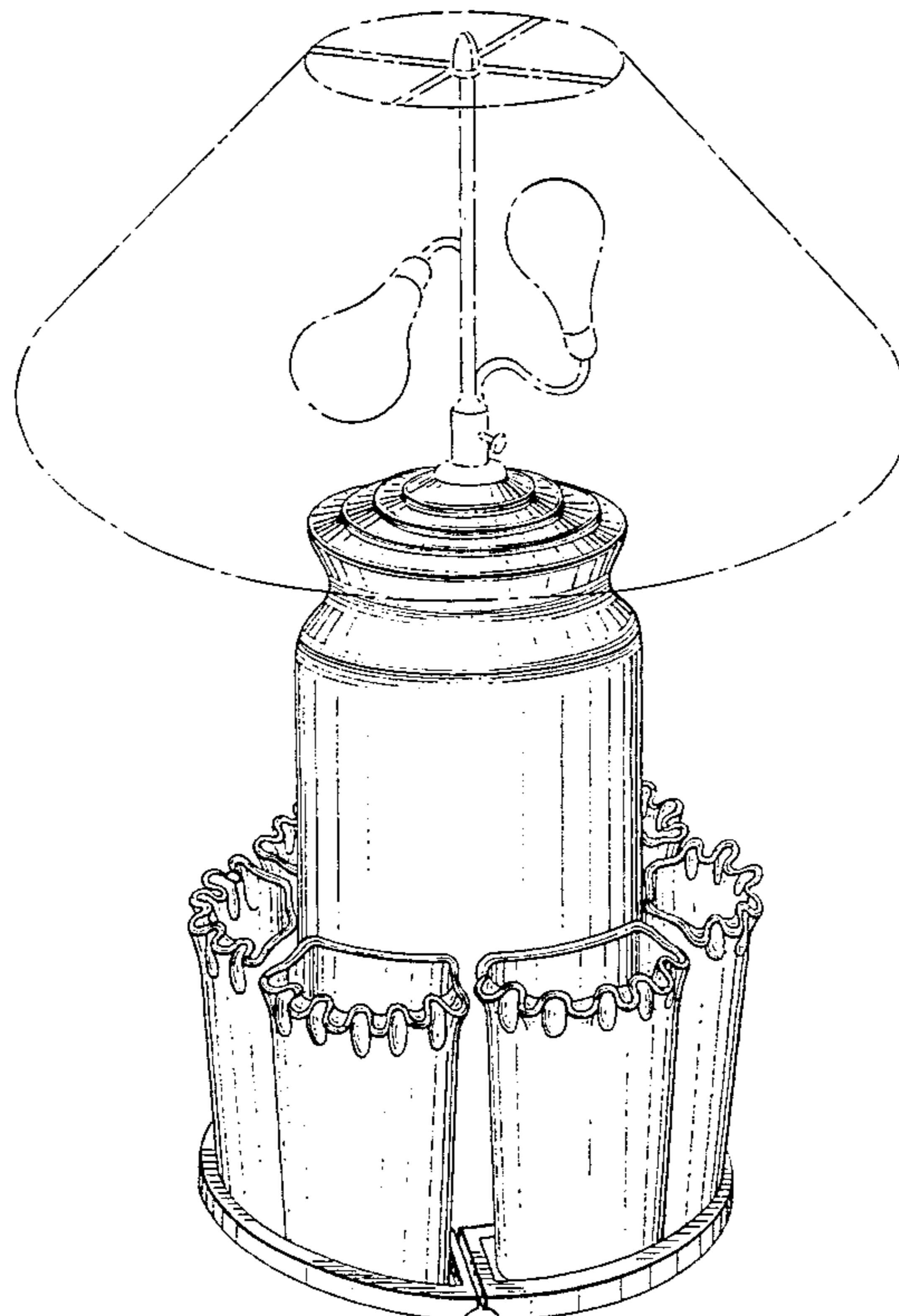

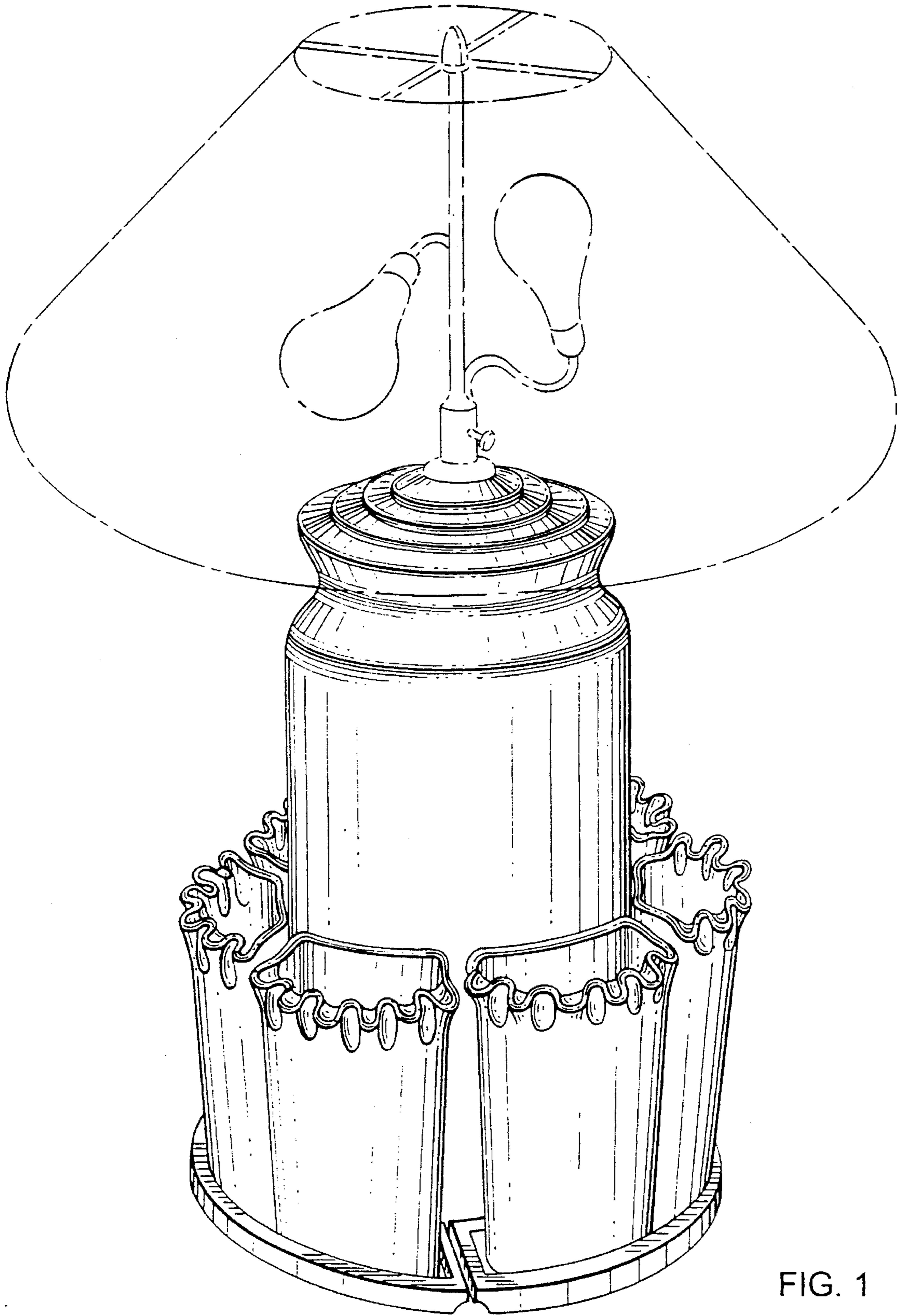

FIG. 1

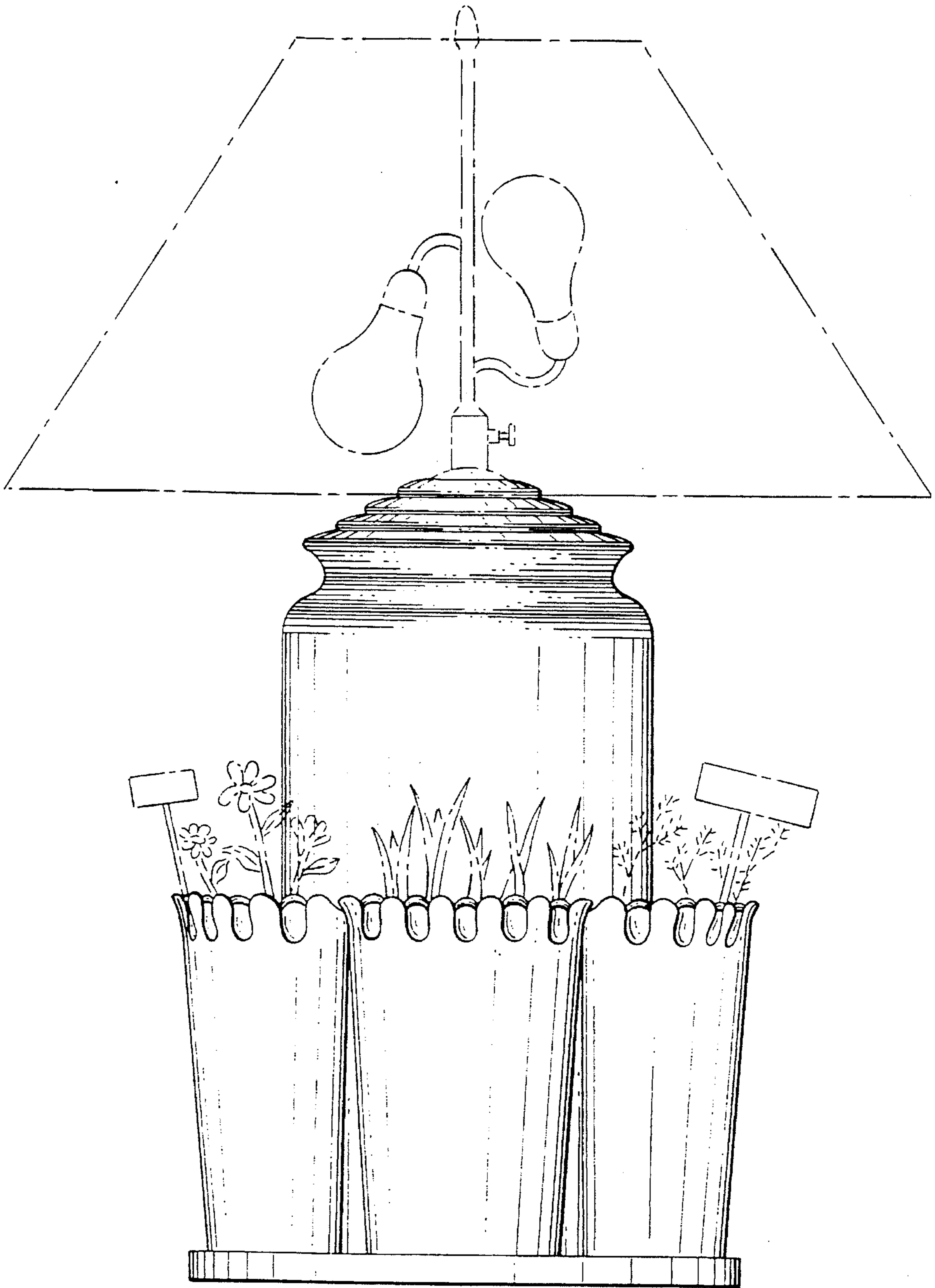

FIG. 2

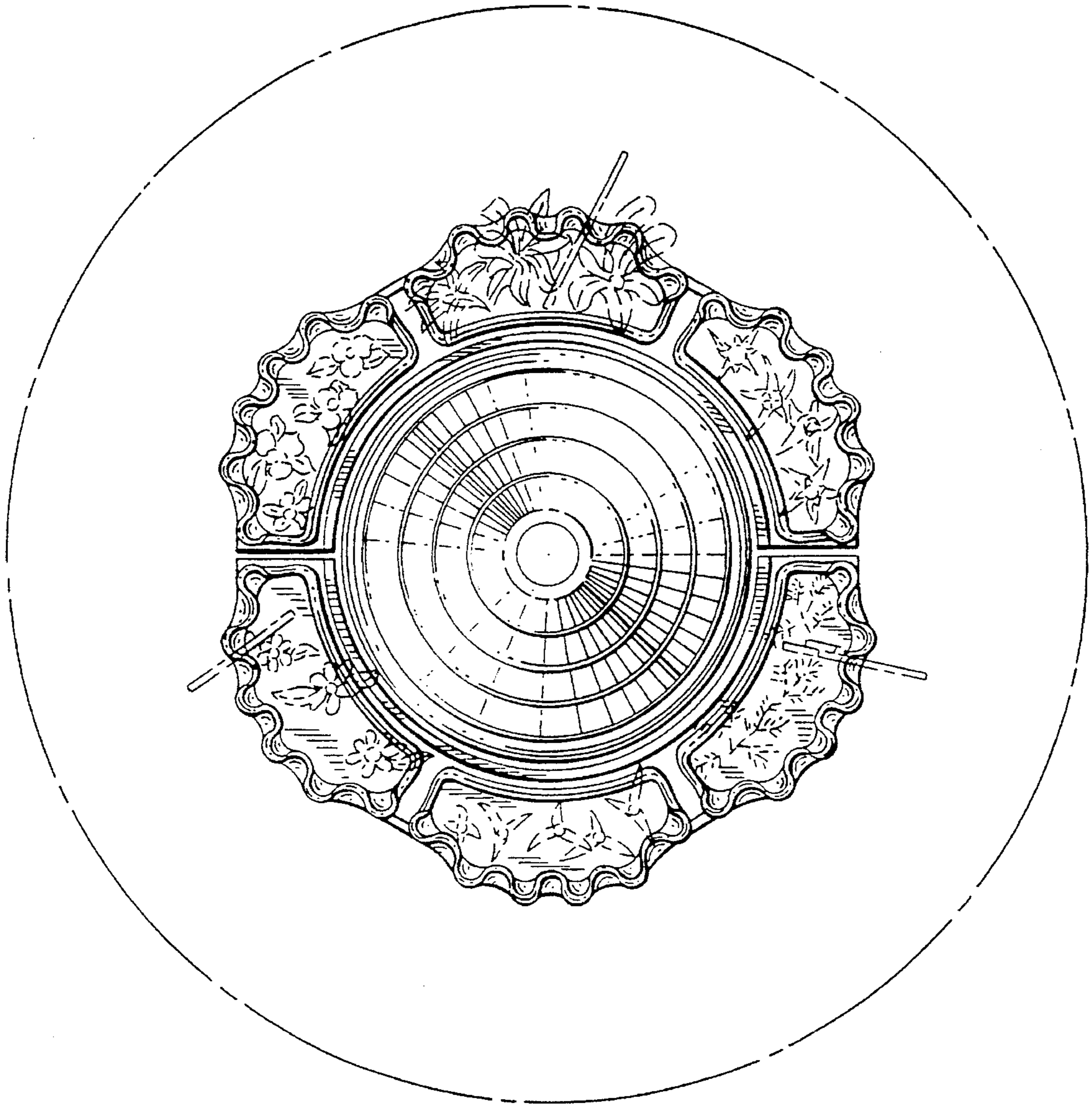

FIG. 3

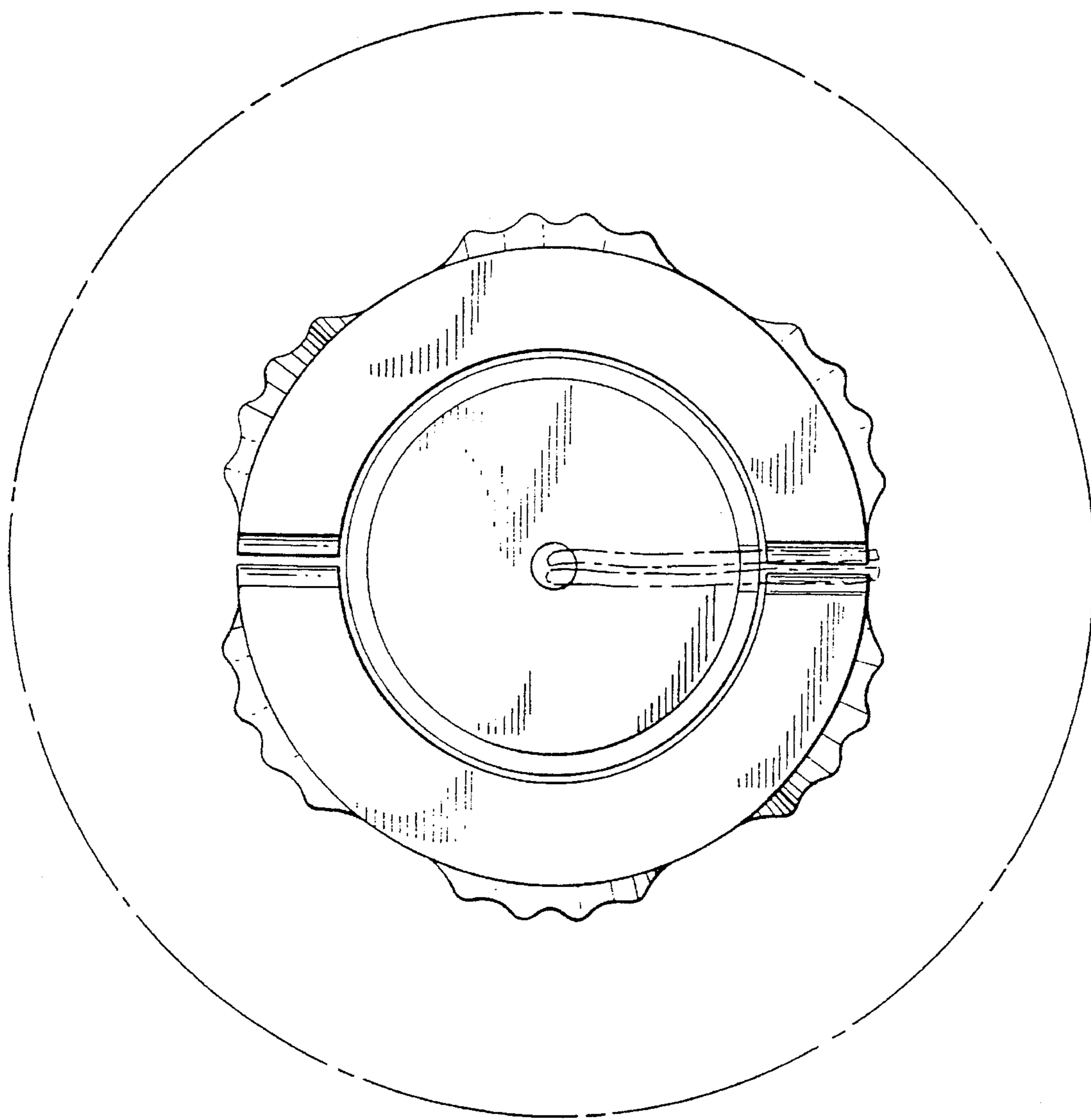

FIG. 4

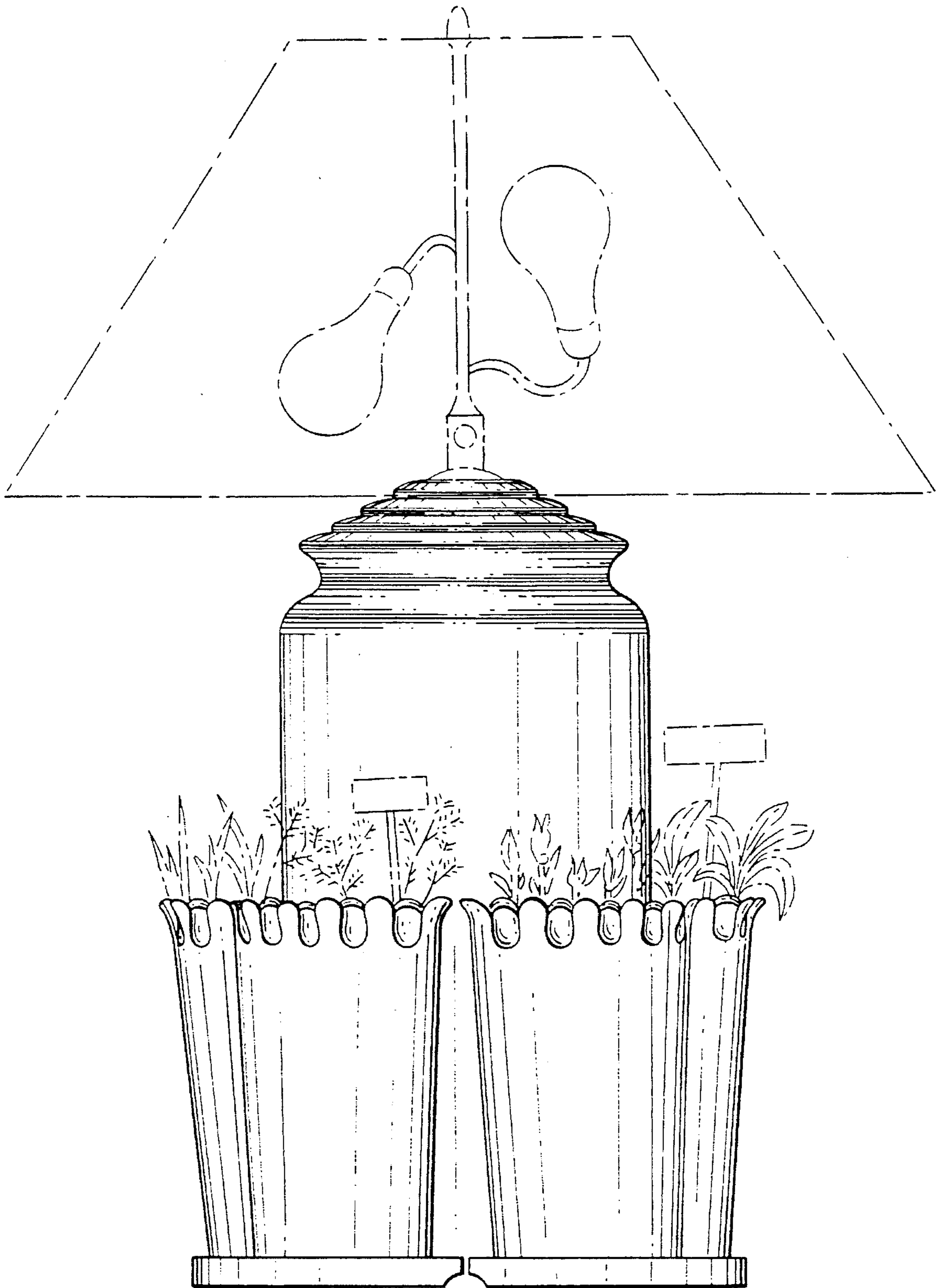

FIG. 5

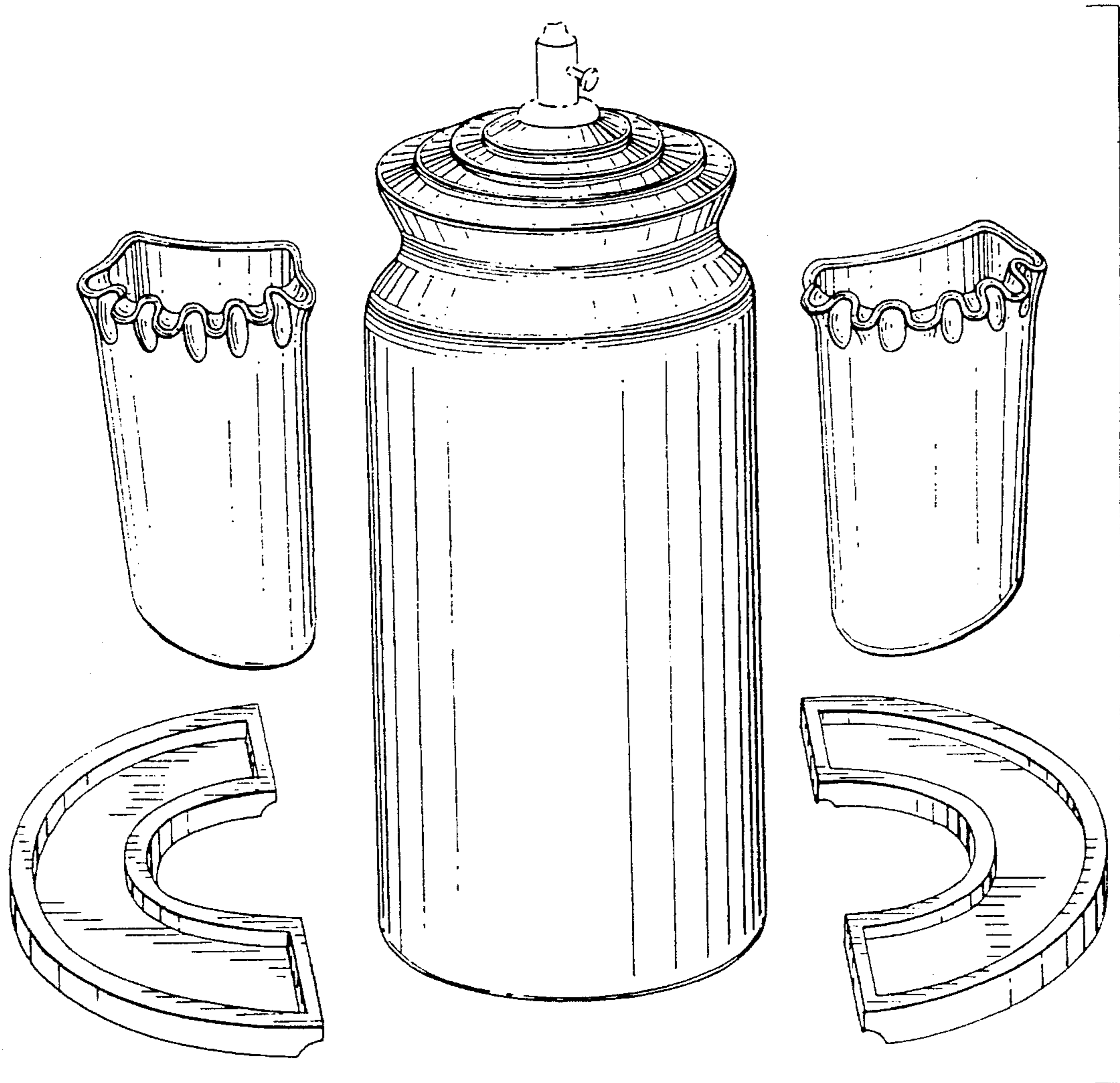

FIG. 6