



US00D374623S

# United States Patent [19]

Rafferty

[11] Patent Number: **Des. 374,623**

[45] Date of Patent: **\*\*Oct. 15, 1996**

[54] **CLOSURE**

[75] Inventor: **Leonora D. Rafferty**, Toledo, Ohio

[73] Assignee: **Owens-Illinois Closure Inc.**, Toledo, Ohio

[\*\*] Term: **14 Years**

[21] Appl. No.: **39,941**

[22] Filed: **Jun. 7, 1995**

[52] U.S. Cl. .... **D9/443**

[58] Field of Search ..... D9/443, 445, 434, D9/435, 452, 453, 454, 300, 505, 338, 302, 436; 215/295, 305, 302; D7/510, 511, 391, 392, 392.1, 538-542; 220/306-308, 254, 711-713

[56] **References Cited**

**U.S. PATENT DOCUMENTS**

- D. 105,256 7/1937 Amrine .
- D. 200,447 2/1965 Lerner ..... D9/435 X
- D. 207,887 6/1967 Parsisson ..... D9/439
- D. 217,543 5/1970 Pomodoro .
- D. 277,458 2/1985 Neggers .
- D. 277,459 2/1985 Baum .
- D. 295,956 5/1988 Holewinski .
- D. 296,081 6/1988 Kuboshima ..... D9/443
- D. 312,043 11/1990 Van Der Tang ..... D9/436
- D. 315,095 3/1991 Wright .

- D. 329,980 10/1992 Powell et al. .... D9/435 X
- D. 349,856 8/1994 Linner ..... D9/435 X
- D. 362,617 9/1995 Linner ..... D9/302
- 4,469,235 9/1984 Parker ..... 215/295
- 5,213,225 5/1993 King .
- 5,358,129 10/1994 Watts ..... 215/305 X

**FOREIGN PATENT DOCUMENTS**

1052164 2/1989 United Kingdom .

*Primary Examiner*—Jeffrey Asch

[57] **CLAIM**

The ornamental design for a closure, as shown and described.

**DESCRIPTION**

FIG. 1 is a perspective view of the closure embodying my novel design;  
 FIG. 2 is an elevational view;  
 FIG. 3 is a plan view;  
 FIG. 4 is a side view taken from the the right in FIG. 2, the view of the opposite side being the same;  
 FIG. 5 is a perspective view of a second embodiment of the design;  
 FIG. 6 is an elevational view of the form shown in FIG. 5;  
 FIG. 7 is a plan view of the form shown in FIG. 5; and,  
 FIG. 8 is a side view taken from the the right in FIG. 6, the view of the opposite side being the same.

**1 Claim, 2 Drawing Sheets**

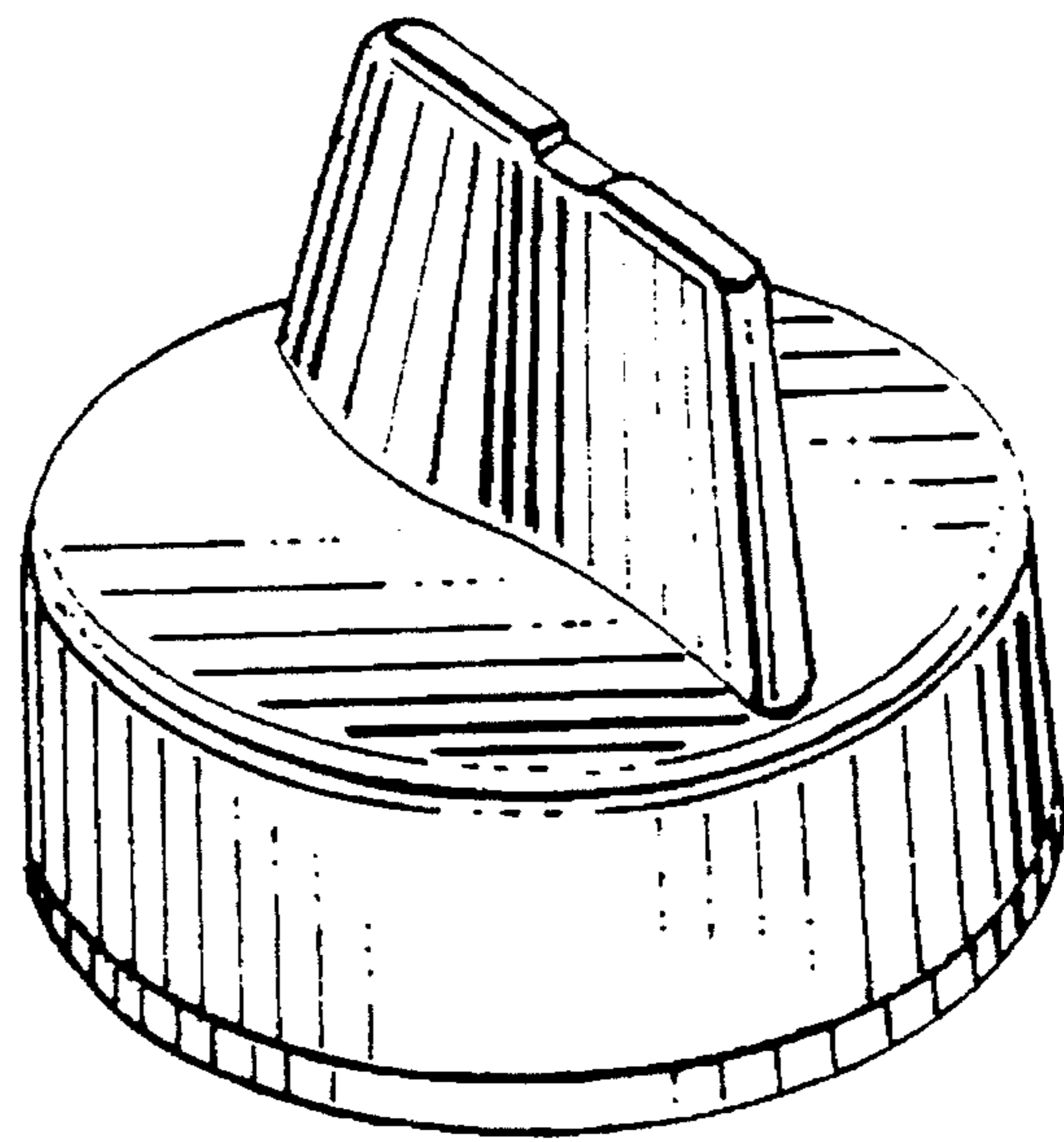
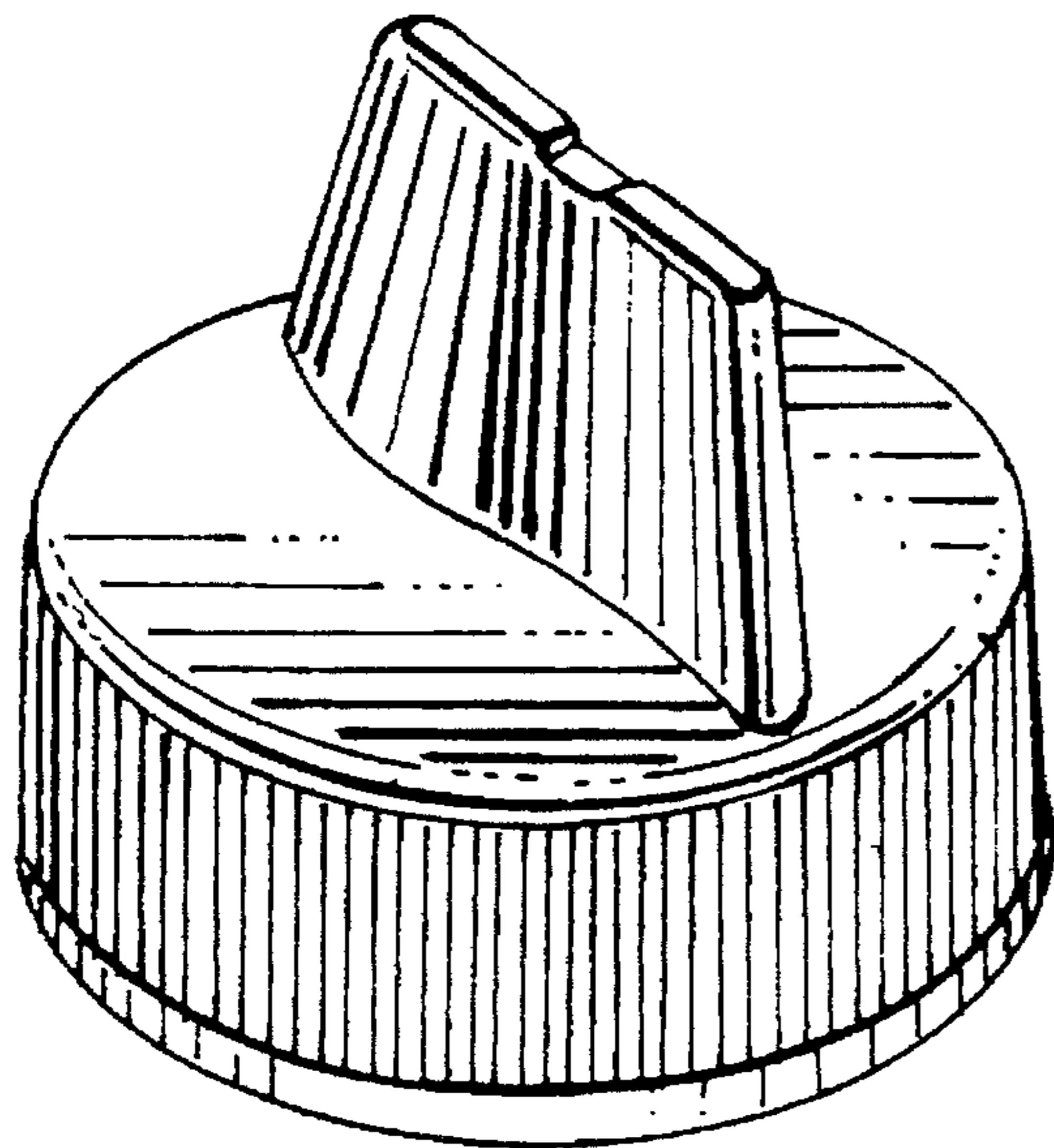

FIG. 2

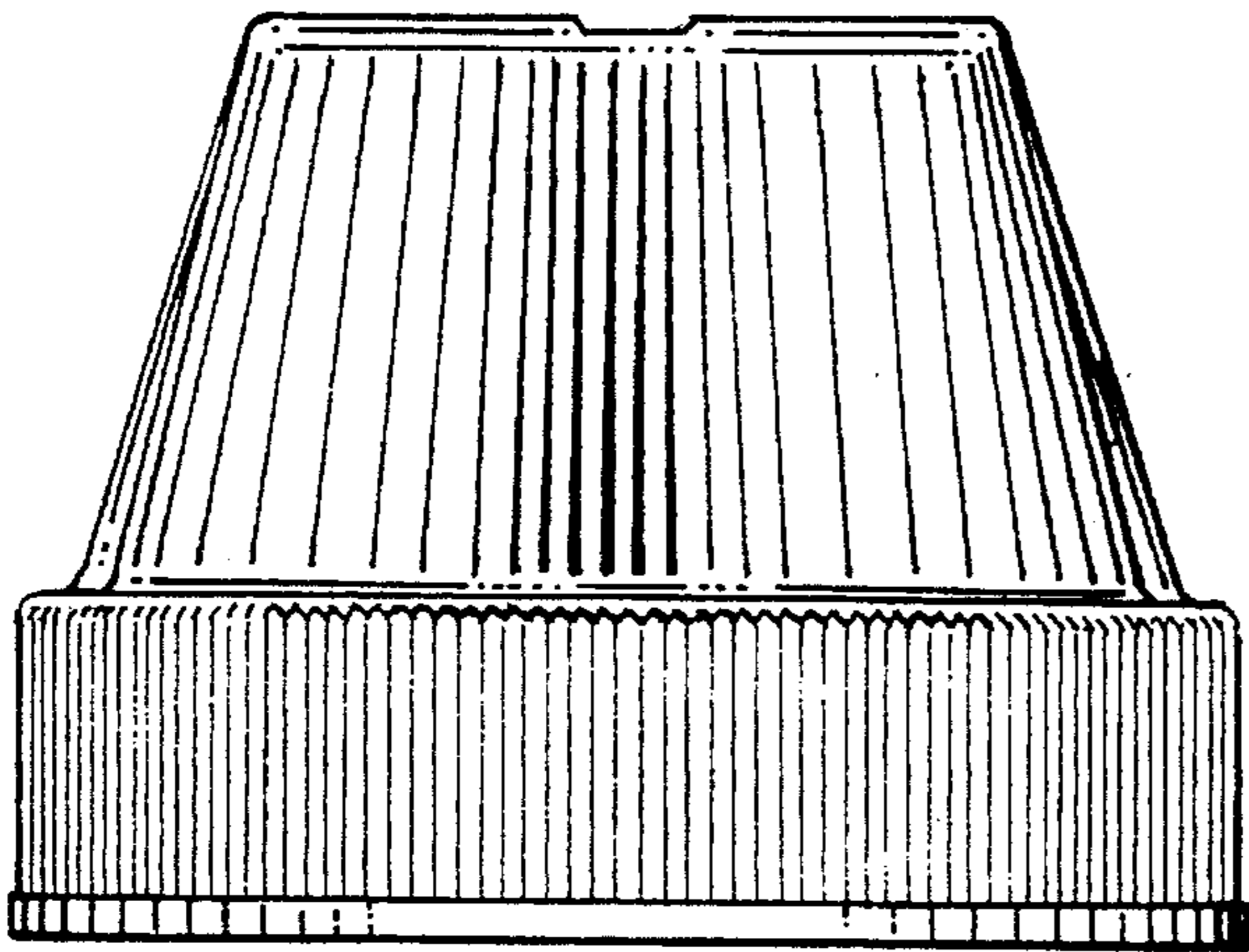

FIG. 1

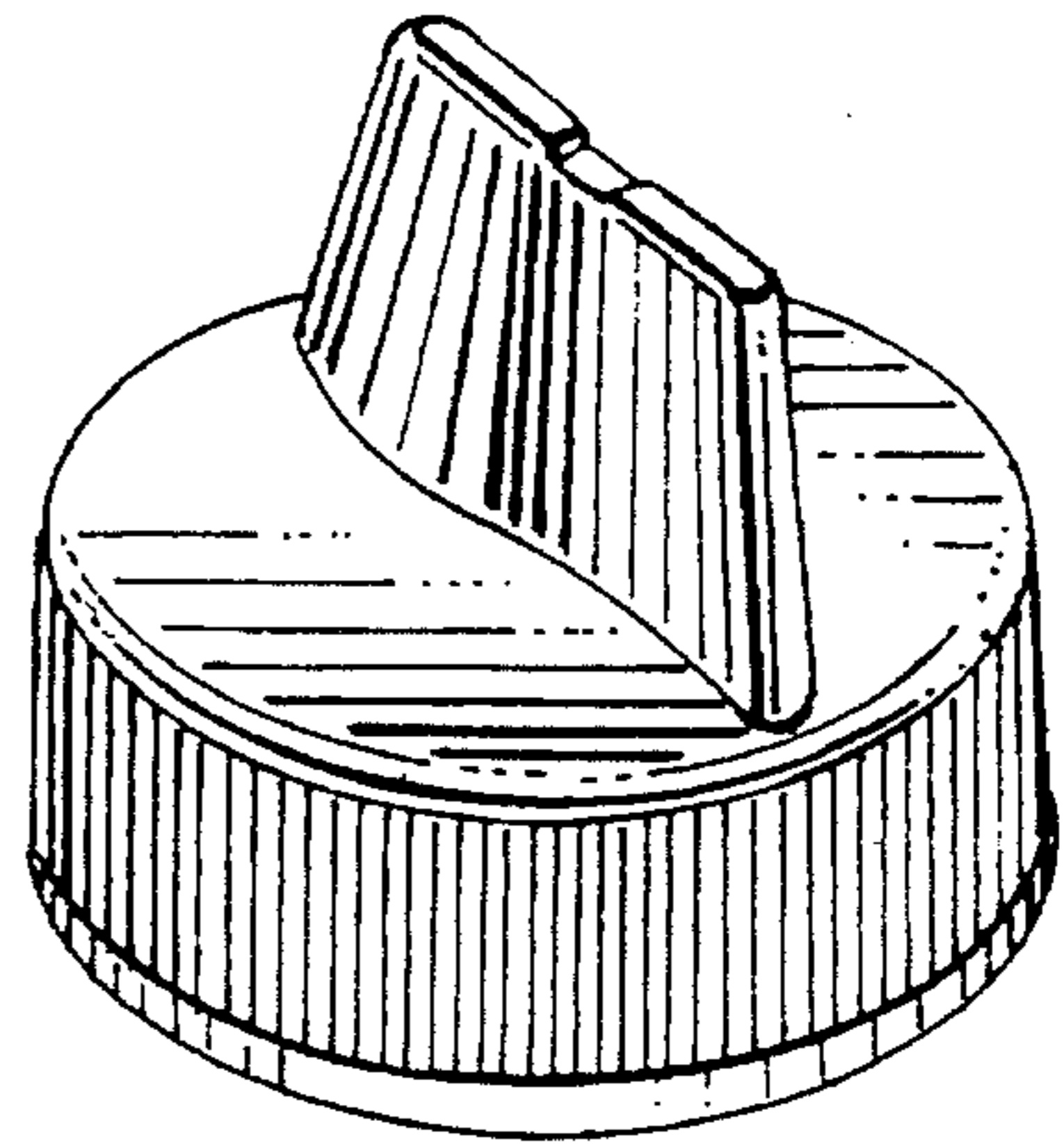

FIG. 3

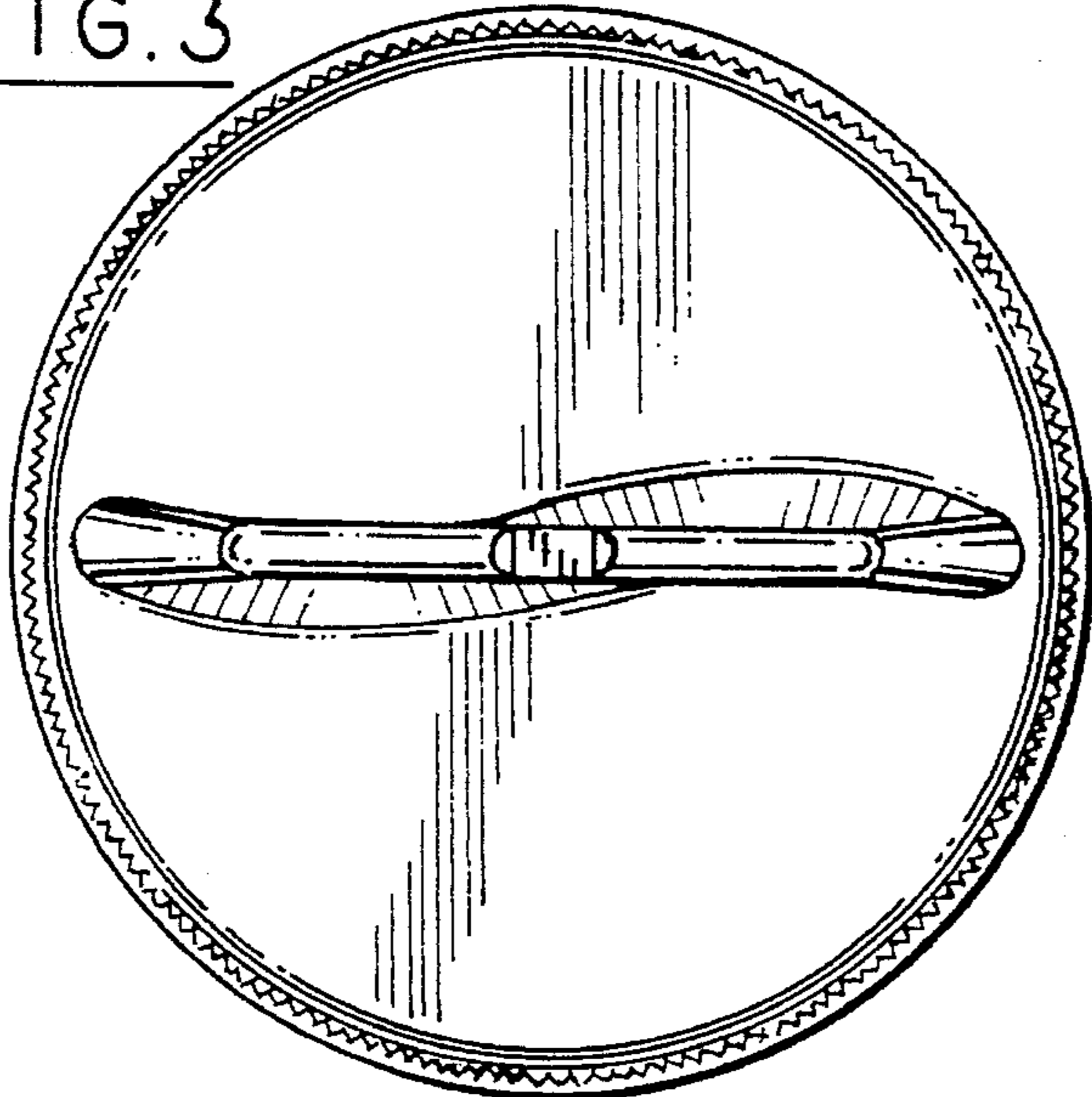

FIG. 4

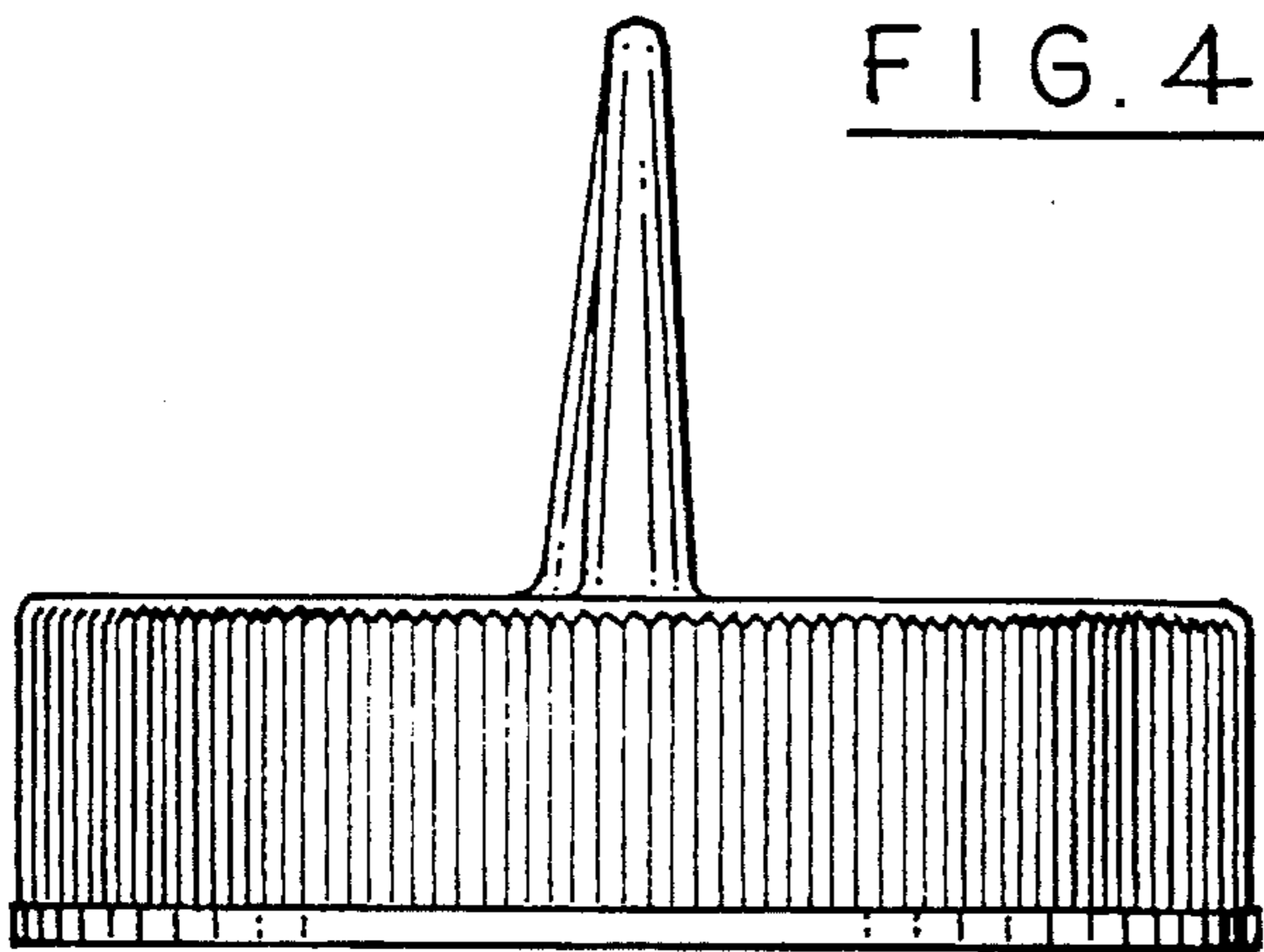

FIG. 6

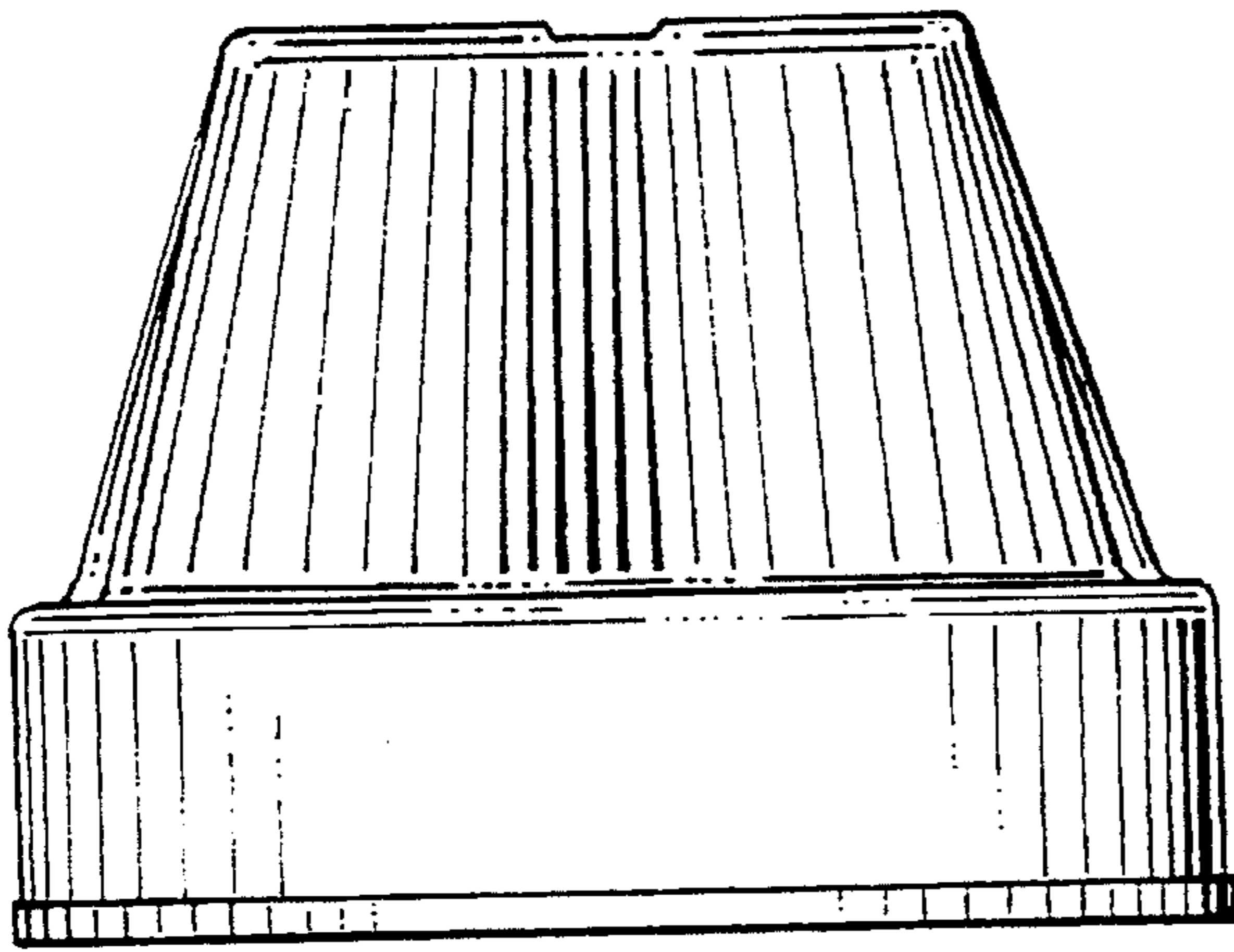

FIG. 5

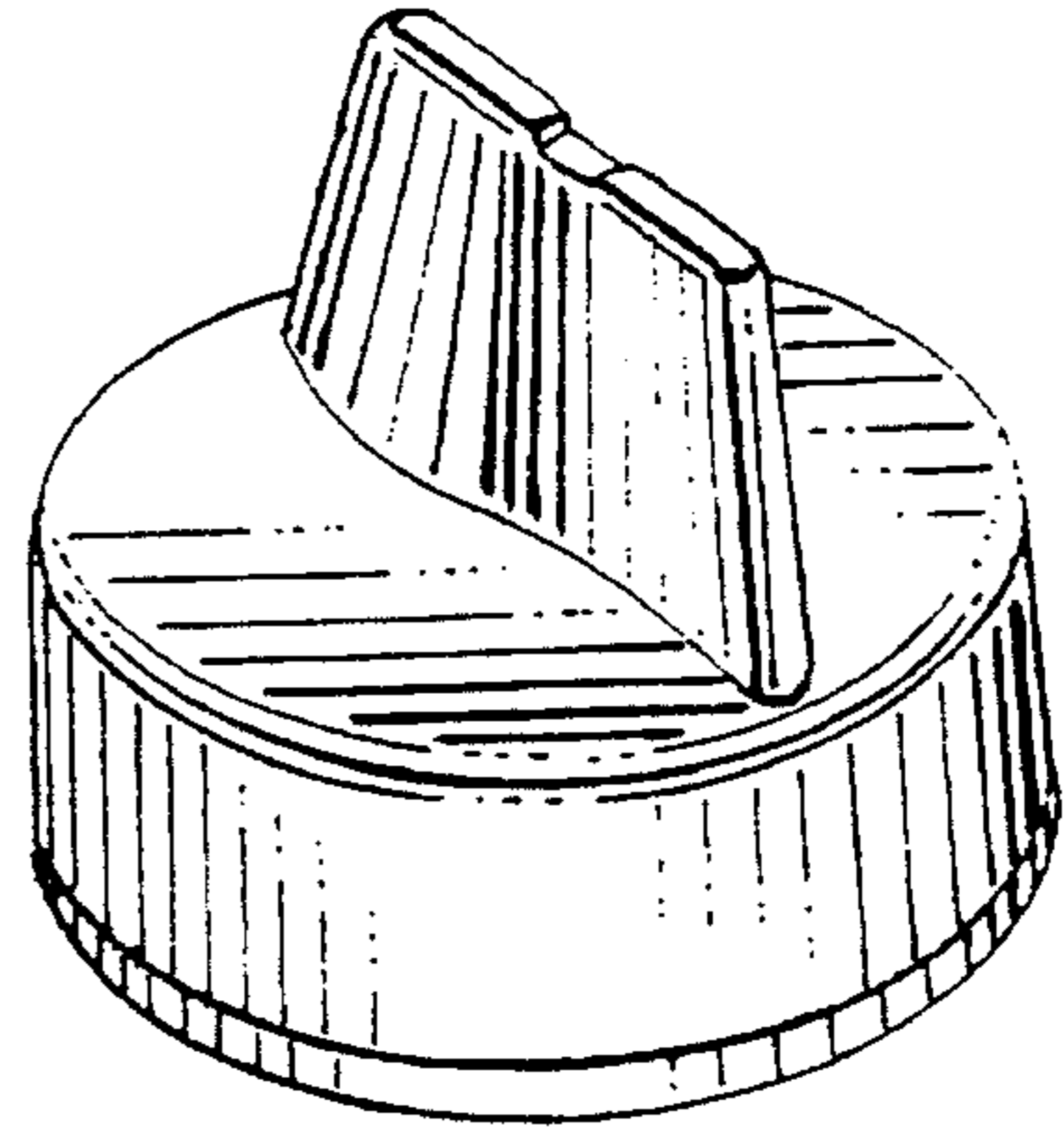

FIG. 7

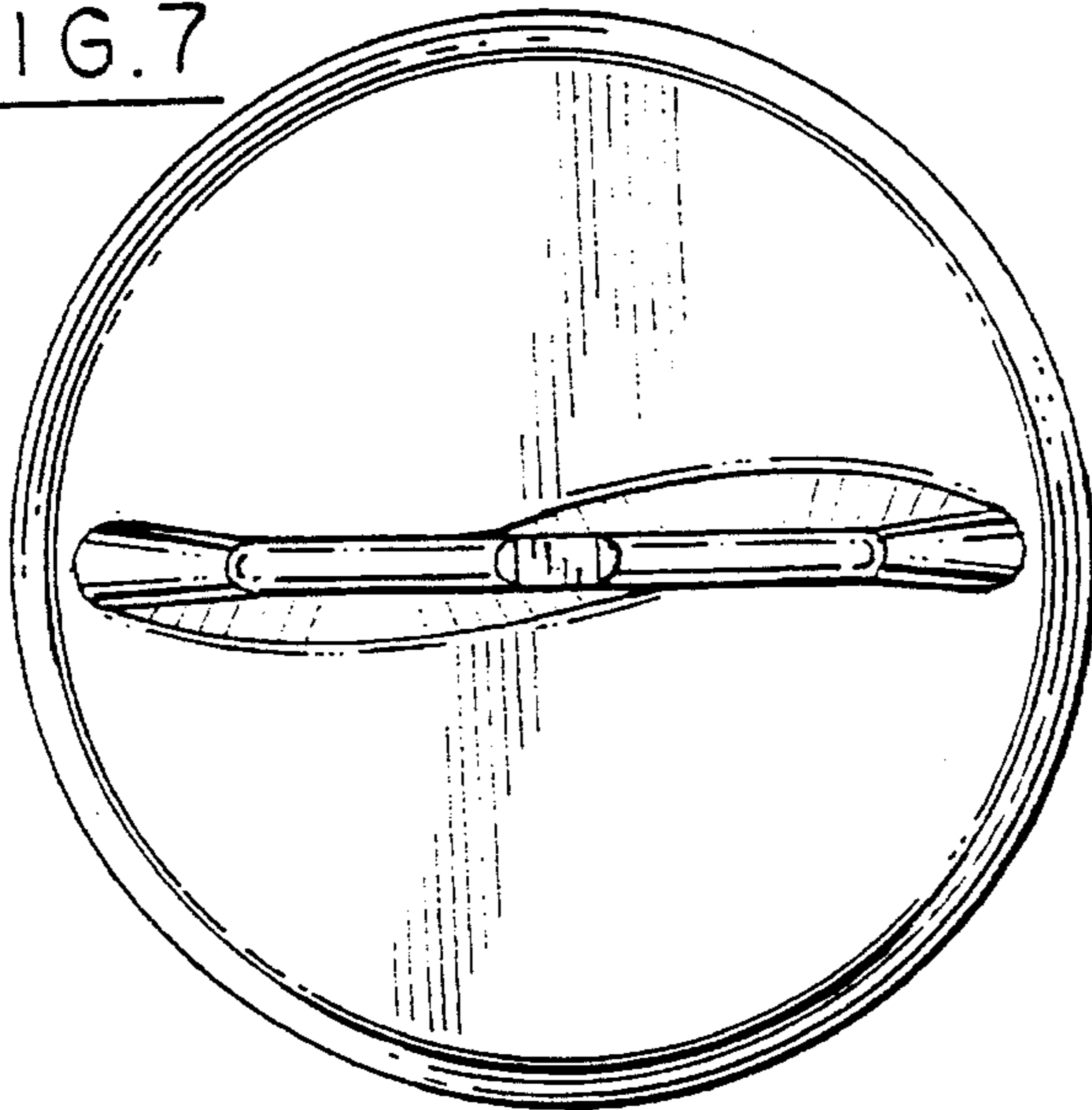

FIG. 8

