



US00D374589S

United States Patent [19]
Chan

[11] **Patent Number: Des. 374,589**

[45] **Date of Patent: **Oct. 15, 1996**

[54] **FOOD PROCESSOR**

D. 361,241 8/1995 Littmann D7/379 X

[75] Inventor: **Yui-Ming Chan, Kwai Chung, Hong Kong**

Primary Examiner—Nelson C. Holtje
Assistant Examiner—Caron D. Veynar
Attorney, Agent, or Firm—Burns, Doane, Swecker & Mathis

[73] Assignee: **Lucky Collection Limited, Hong Kong, Hong Kong**

[57] **CLAIM**

[**] Term: **14 Years**

The ornamental design for a “food processor”, as shown and described.

[21] Appl. No.: **45,170**

DESCRIPTION

[22] Filed: **Oct. 11, 1995**

[52] U.S. Cl. **D7/379; D7/376; D7/384**

[58] Field of Search **D7/376–386, 413; 366/129, 130, 199, 204, 205, 314**

FIG. 1 is the front elevational view of a “food processor” showing my new design;
FIG. 2 is the rear elevational view thereof;
FIG. 3 is the left side view thereof;
FIG. 4 is the right side view thereof;
FIG. 5 is the top plan view thereof; and,
FIG. 6 is the bottom view thereof.

[56] **References Cited**

U.S. PATENT DOCUMENTS

- D. 271,176 11/1983 Zimnowicz D7/379
- D. 347,965 6/1994 Hoffman et al. D7/379 X

1 Claim, 3 Drawing Sheets

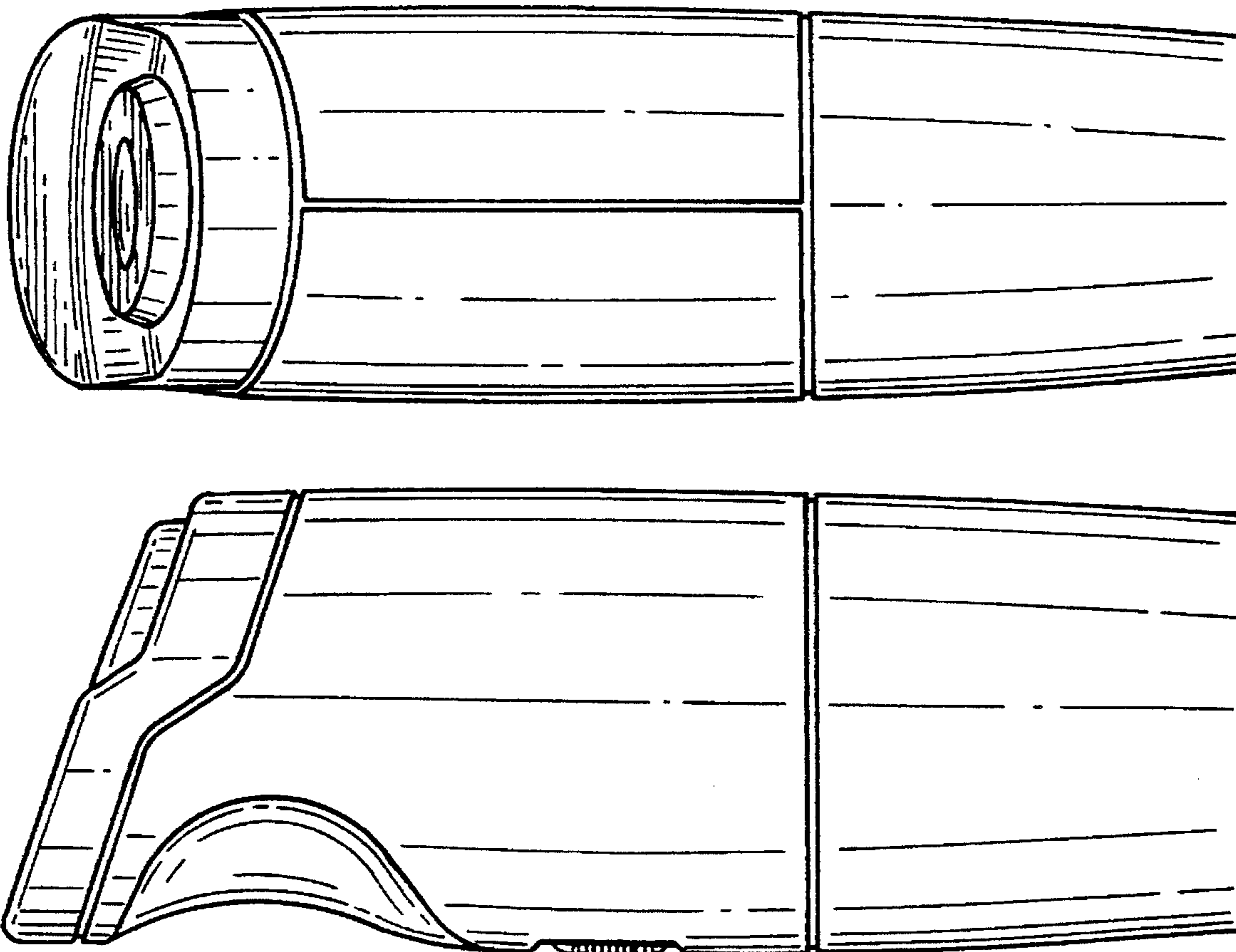

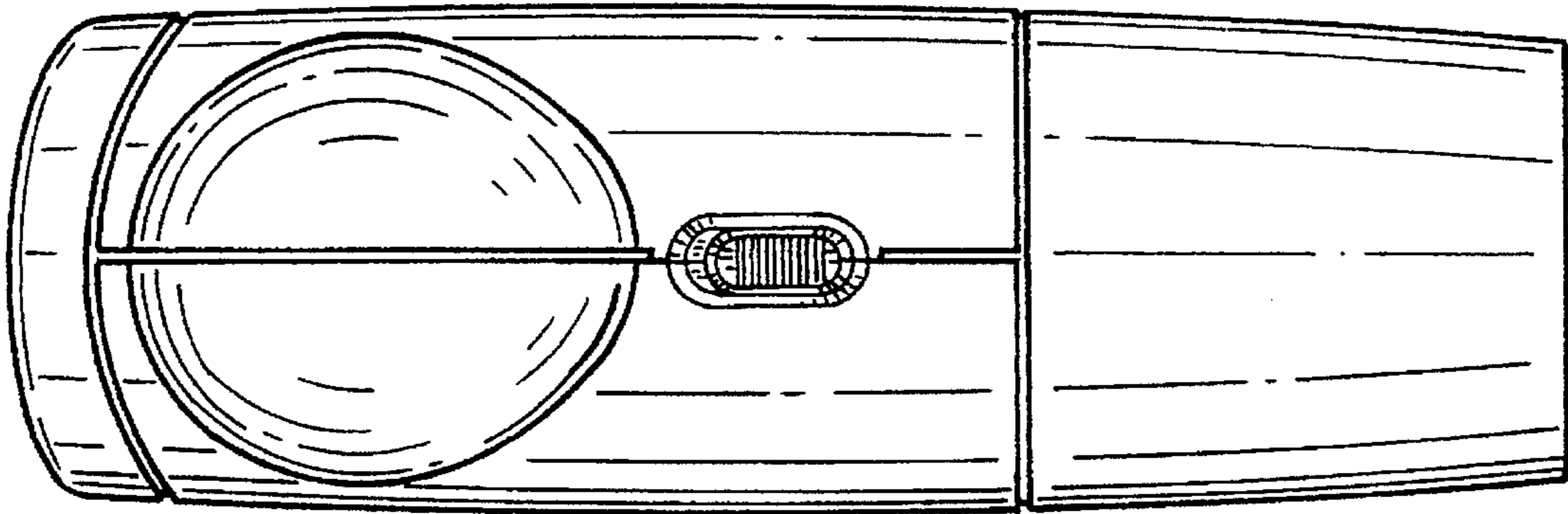

FIG. 1

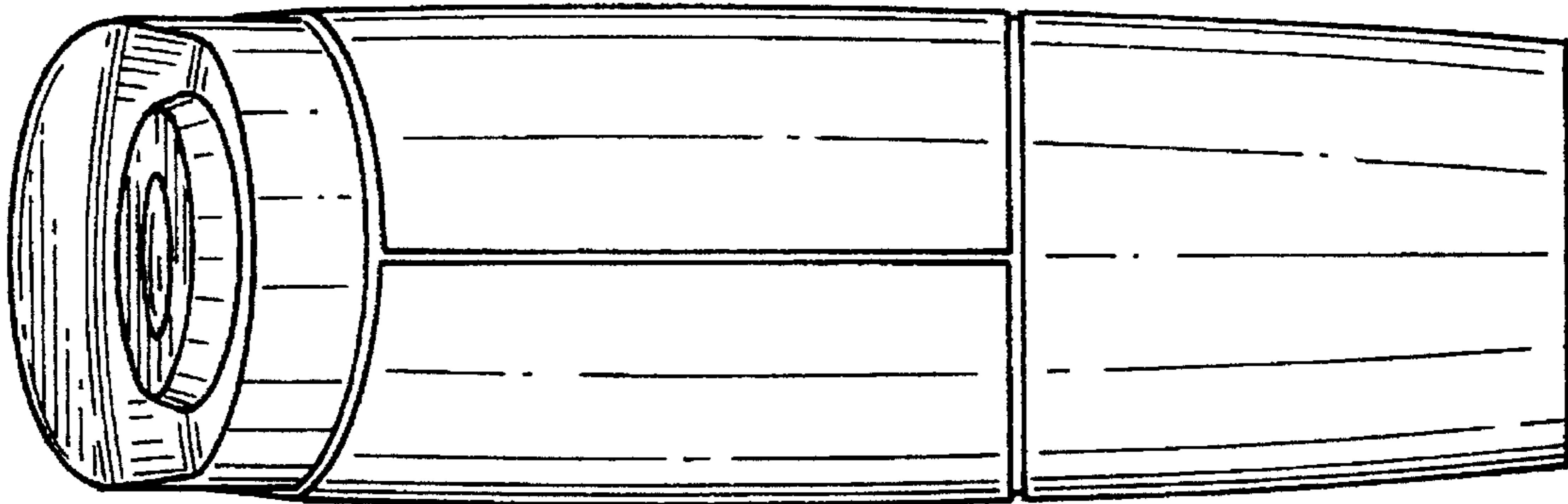

FIG. 2

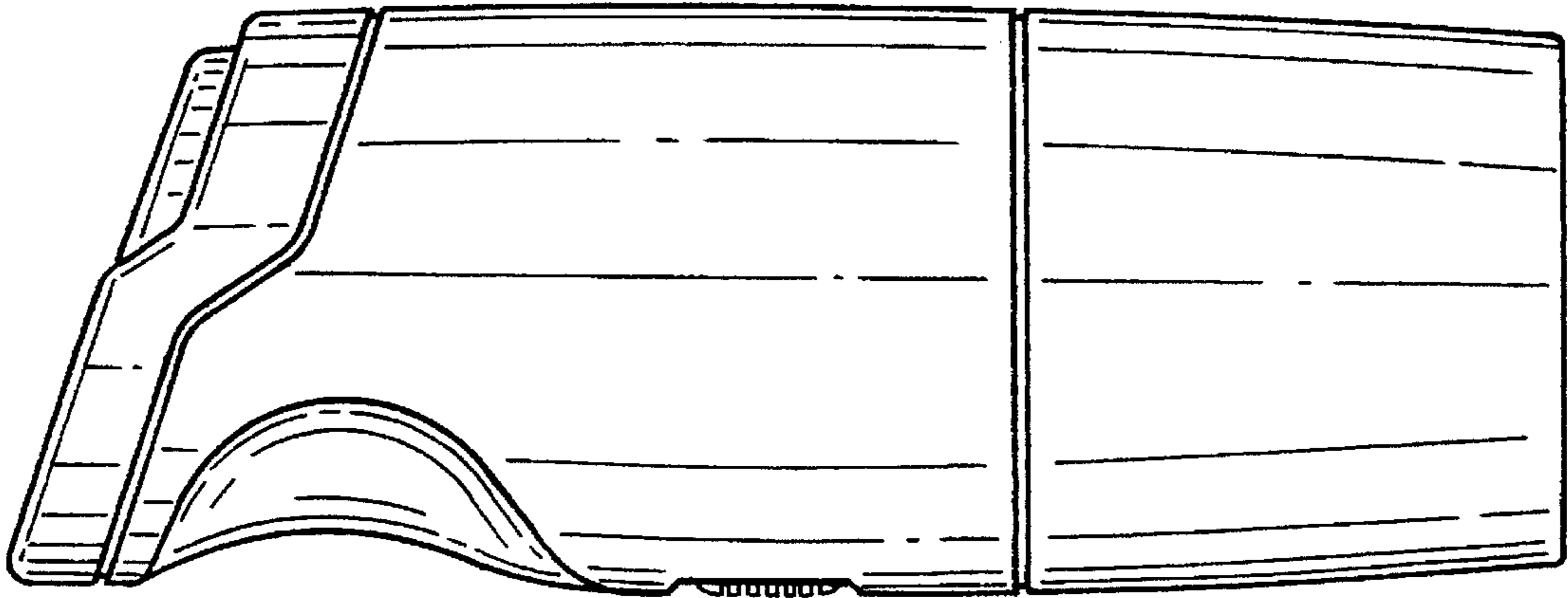

FIG. 3

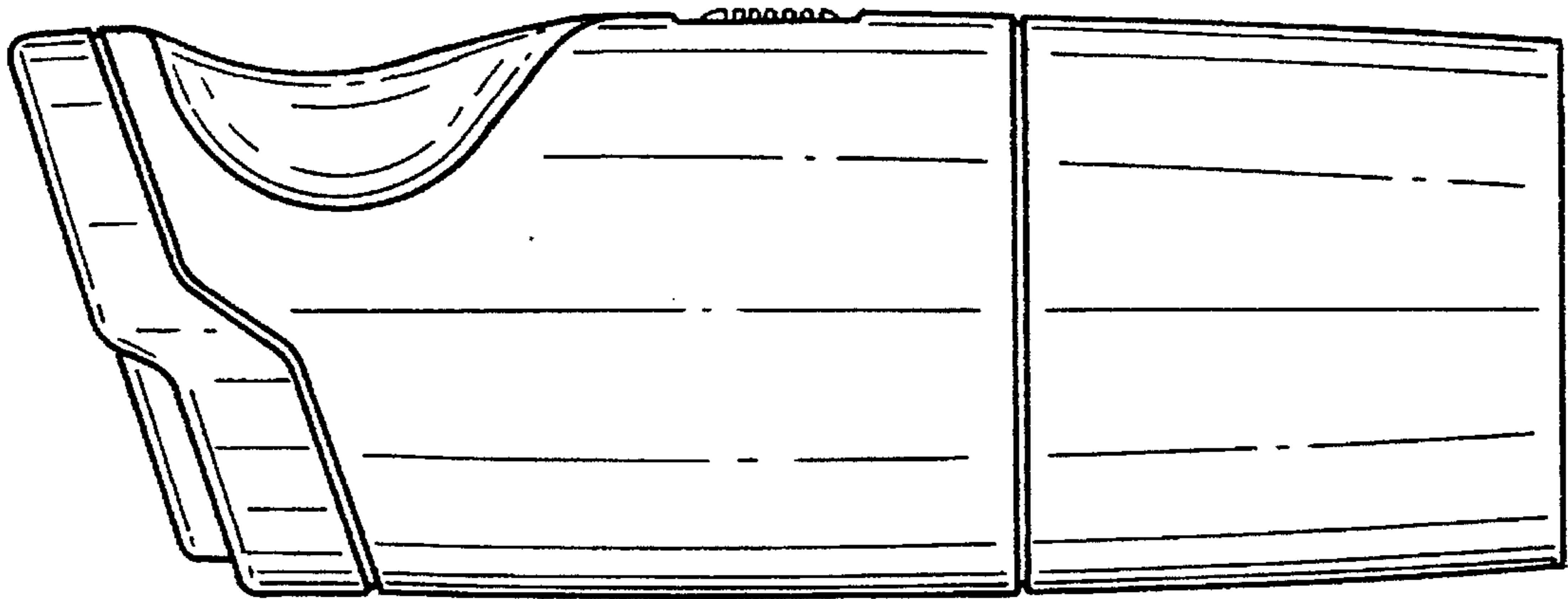

FIG. 4

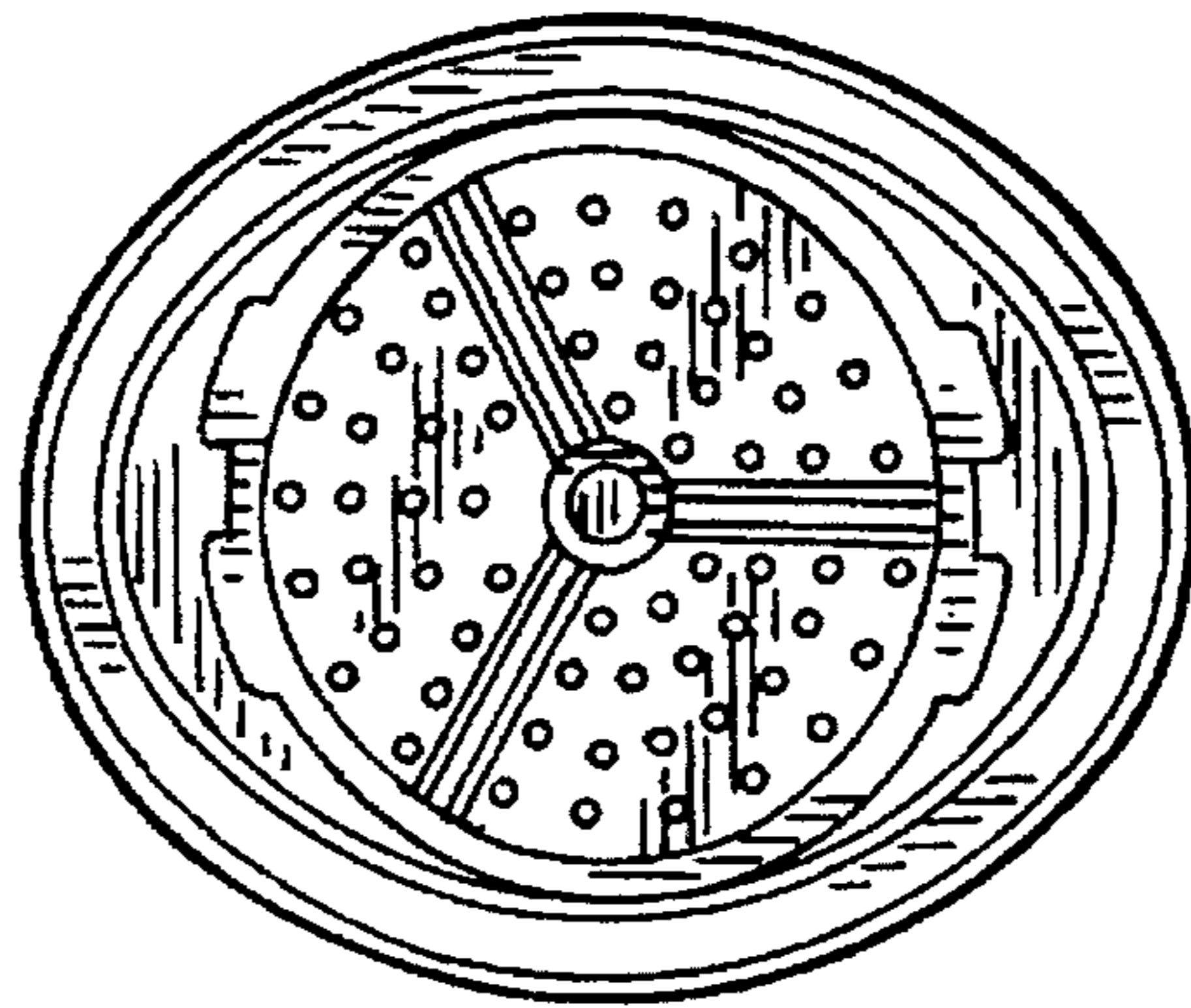

FIG. 5

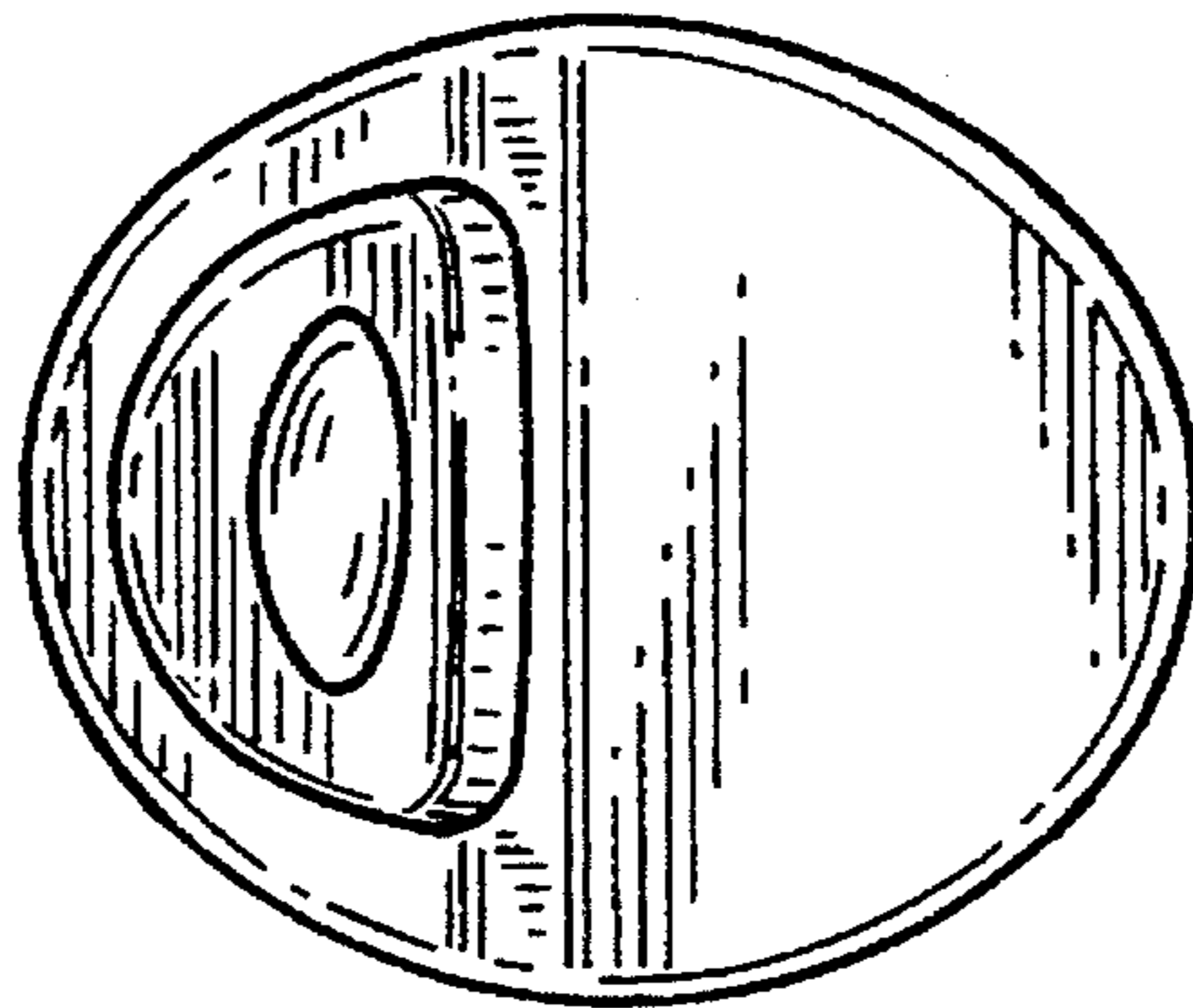

FIG. 6