



US00D374512S

United States Patent [19]

[11] Patent Number: **Des. 374,512**

Kiley et al.

[45] Date of Patent: ****Oct. 8, 1996**

[54] **SHADE STRUCTURE FOR SMALL ANIMALS**

782578	6/1935	France	119/28.5
2216999	10/1973	Germany	297/184
426174	10/1947	Italy	5/418
488718	3/1955	Italy	135/137
633949	2/1962	Italy	135/121
250286	6/1948	Switzerland	119/28.5
809621	2/1959	United Kingdom	135/124

[75] Inventors: **Susan E. Kiley**, Longwood; **Brenda Farrell**, Winter Springs; **Fred J. Reule**, Longwood; **James E. Vaughn**, Orlando, all of Fla.

[73] Assignee: **Gale Group, Inc.**, Apopka, Fla.

Primary Examiner—Cathy Anne MacCormac
Attorney, Agent, or Firm—Allen, Dyer, Doppelt, Franjola & Milbrath, P.A.

[**] Term: **14 Years**

[21] Appl. No.: **29,264**

[57] CLAIM

[22] Filed: **Aug. 12, 1994**

The ornamental design for a shade structure for small animals, as shown and described.

[52] U.S. Cl. **D30/118**; D30/108; 135/137; 135/124; 135/87; D6/491

DESCRIPTION

[58] **Field of Search** 119/28.5, 19, 17; 135/121-124, 115, 116, 137, 87, 98, 136; 5/121-122, 127-128, 113, 418, 97; 297/184.1, 184.11, 184.13-184.15, 184.17; D21/253; D6/491

FIG. 1 is a top left perspective view of a shade structure for small animals showing our new design;
FIG. 2 is a left side elevational view thereof, the opposite side is a mirror image of the side shown;
FIG. 3 is a top plan view thereof;
FIG. 4 is a bottom plan view thereof;
FIG. 5 is a front elevational view thereof;
FIG. 6 is a rear elevational view thereof;
FIG. 7 is a top, left perspective view of a second embodiment of FIG. 1;
FIG. 8 is a left side elevational view of the embodiment of FIG. 7, the opposite side is a mirror image of the side shown;
FIG. 9 is a top plan view of FIG. 7;
FIG. 10 is a bottom plan view of FIG. 7;
FIG. 11 is a front elevational view of FIG. 7; and,
FIG. 12 is a rear elevational view of FIG. 7.

[56] References Cited

U.S. PATENT DOCUMENTS

D. 56,367	10/1920	Leijen	297/184.14
D. 294,752	3/1988	Palier	119/28.5
1,887,108	11/1932	Steese	119/19
2,109,881	3/1938	Goldberg	297/184.11
2,190,566	2/1940	Julian	D21/253
3,070,107	12/1962	Bratty	135/123
3,155,427	11/1964	Necessary	297/184.14
4,063,318	12/1977	Nicholson	297/184.17
4,646,770	3/1987	Lobato	135/137
4,821,353	4/1989	Neri	5/418
5,277,148	11/1994	Rossignol et al.	119/19

FOREIGN PATENT DOCUMENTS

210079	7/1960	Austria	135/124
--------	--------	---------------	---------

1 Claim, 2 Drawing Sheets

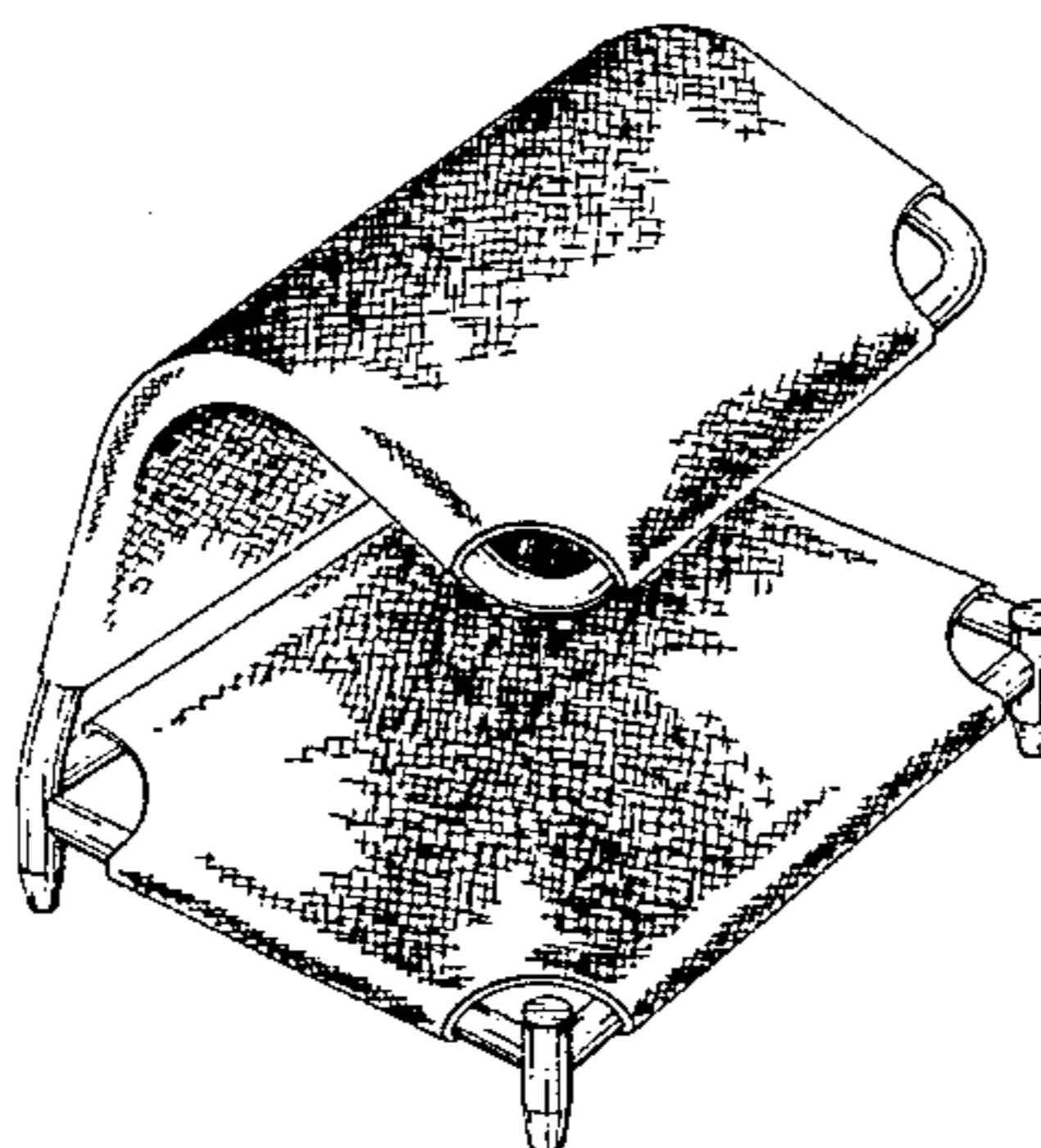
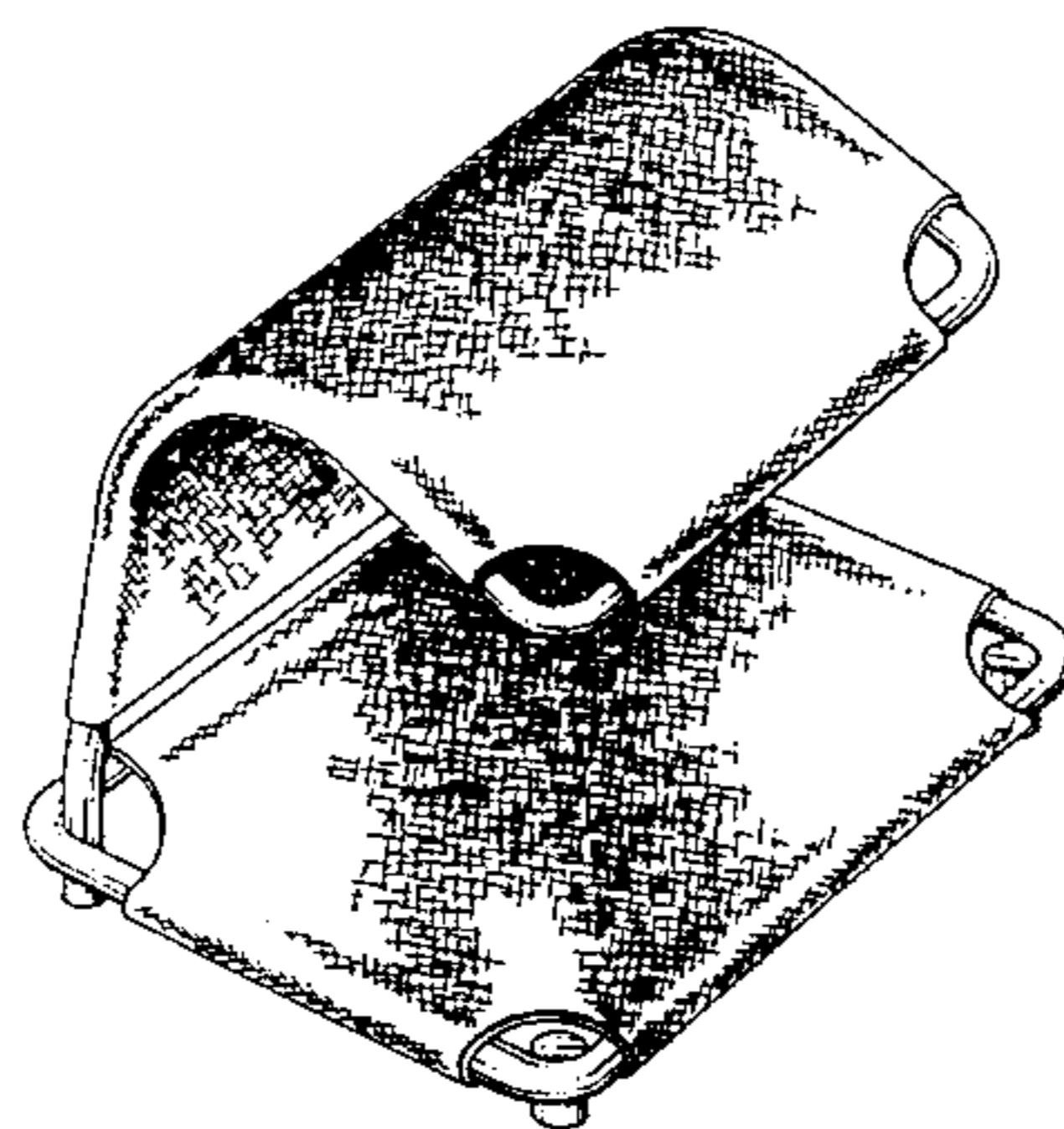

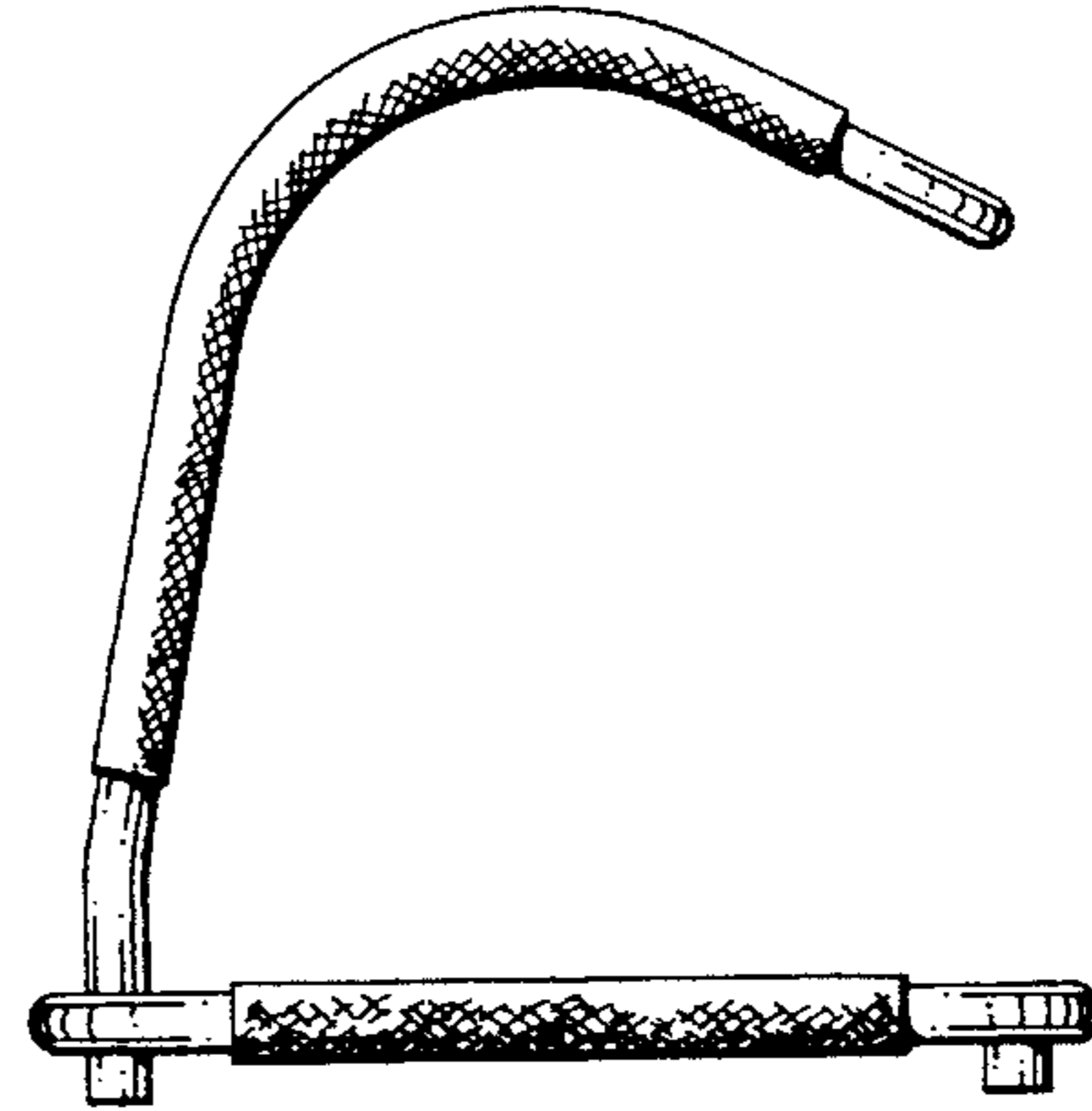
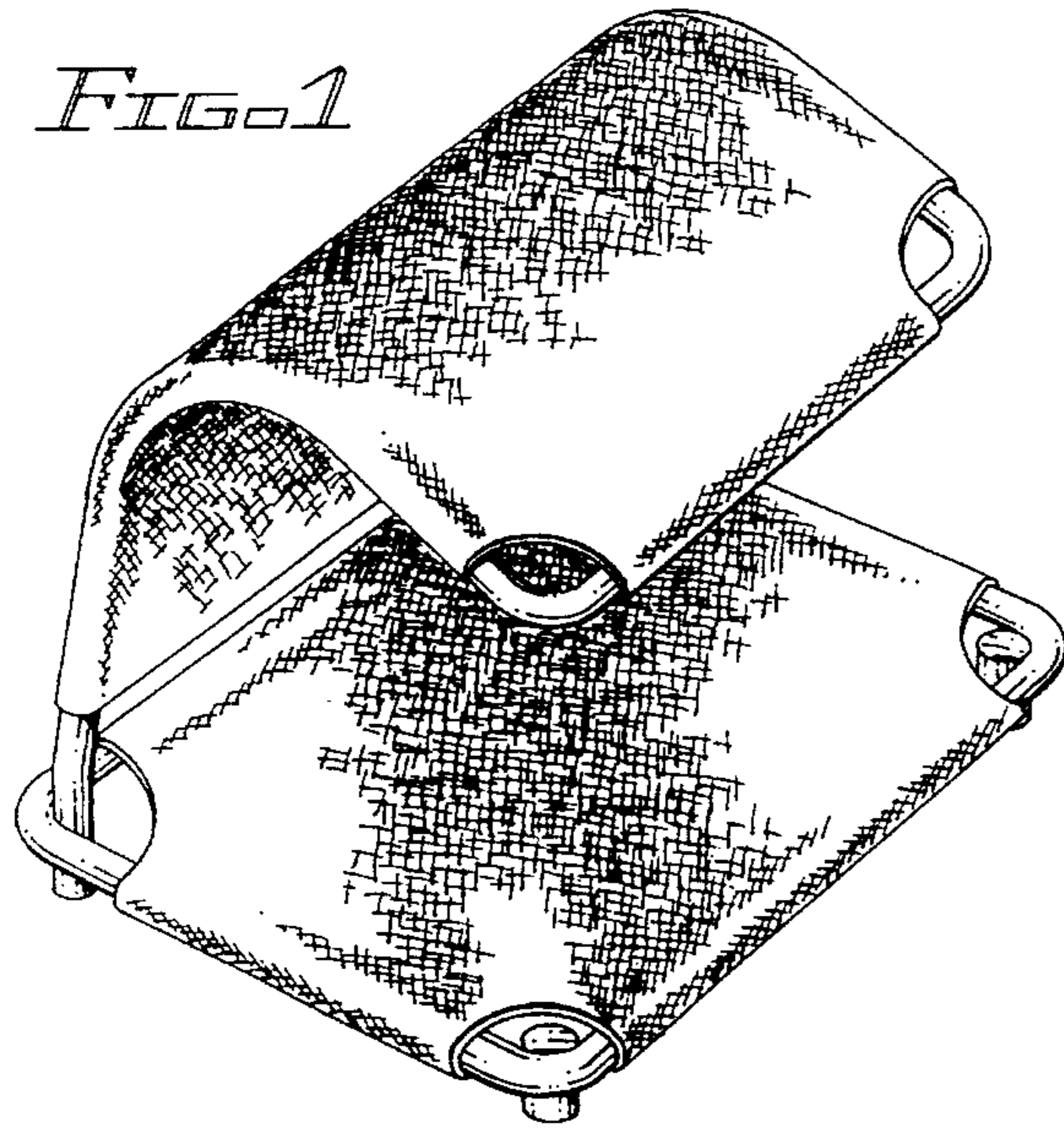

FIG. 2

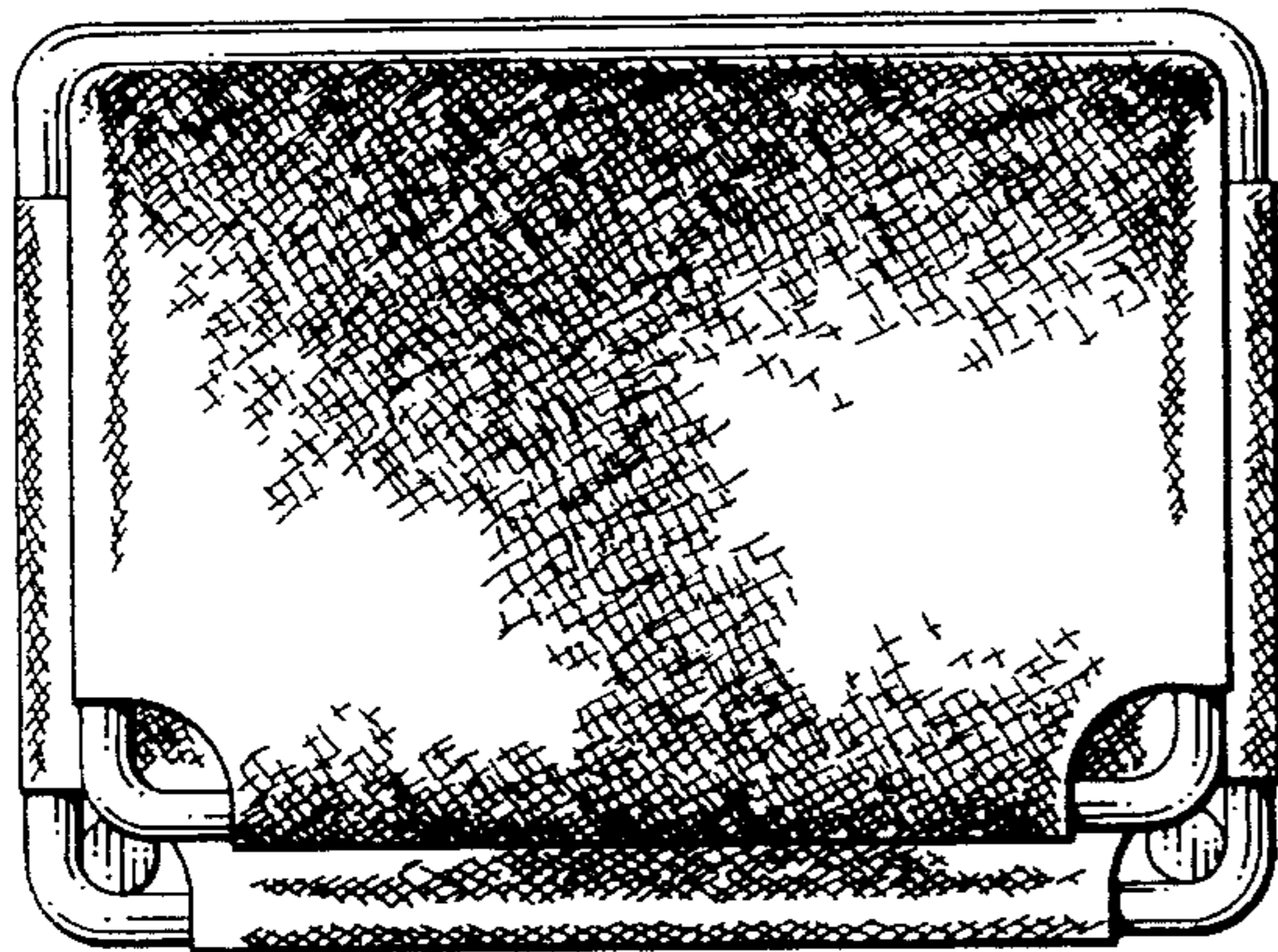

FIG. 3

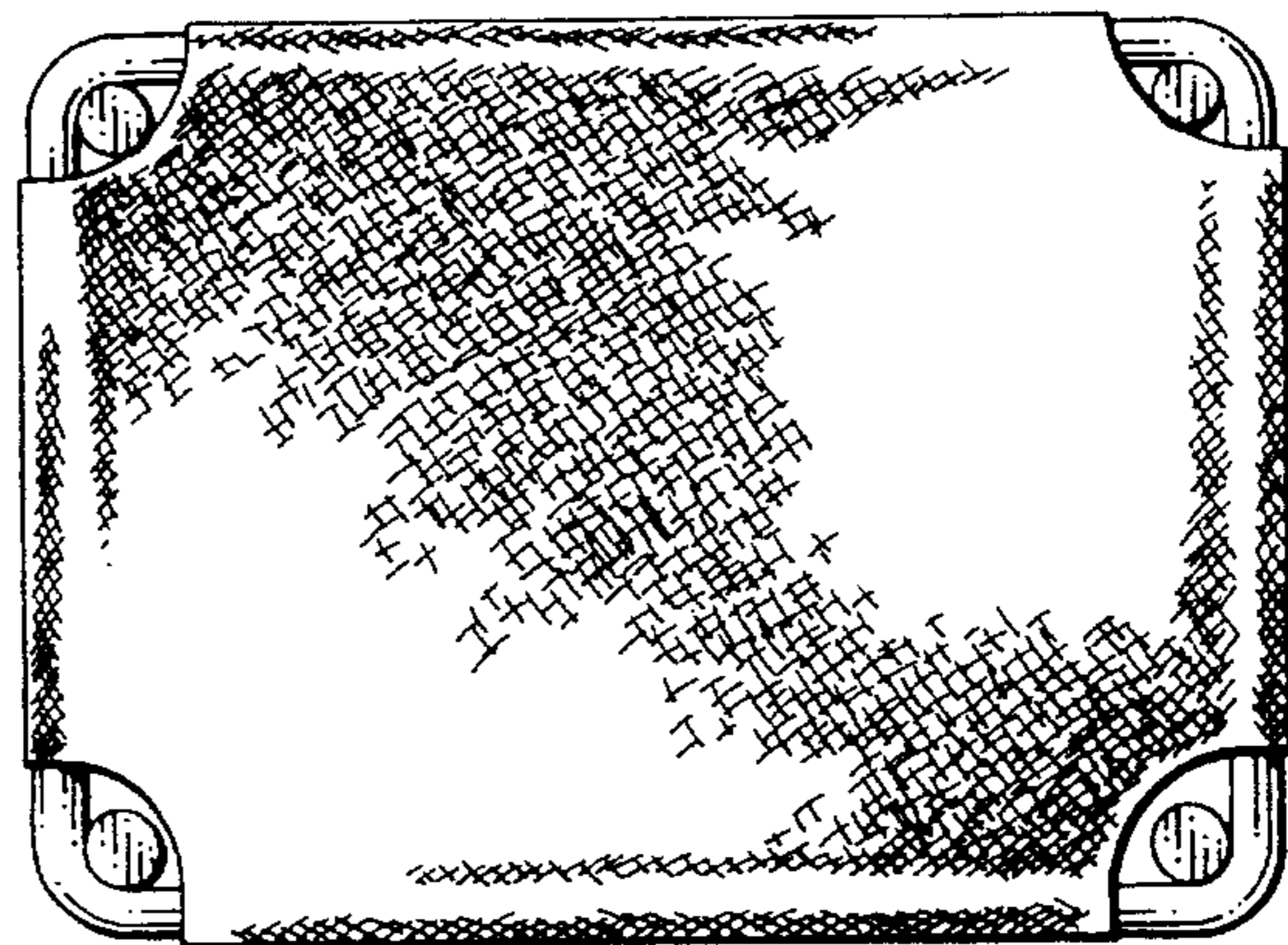

FIG. 4

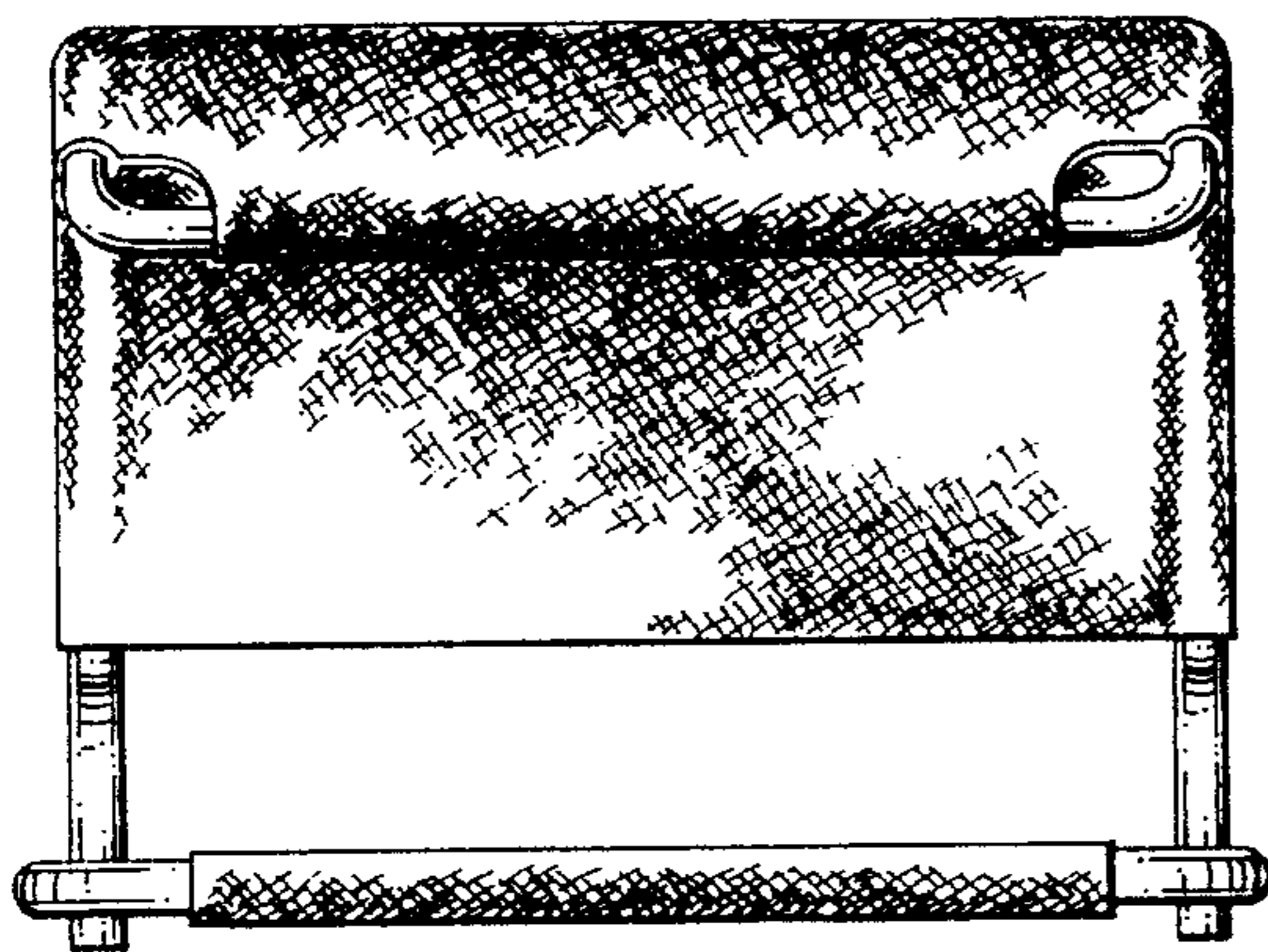

FIG. 5

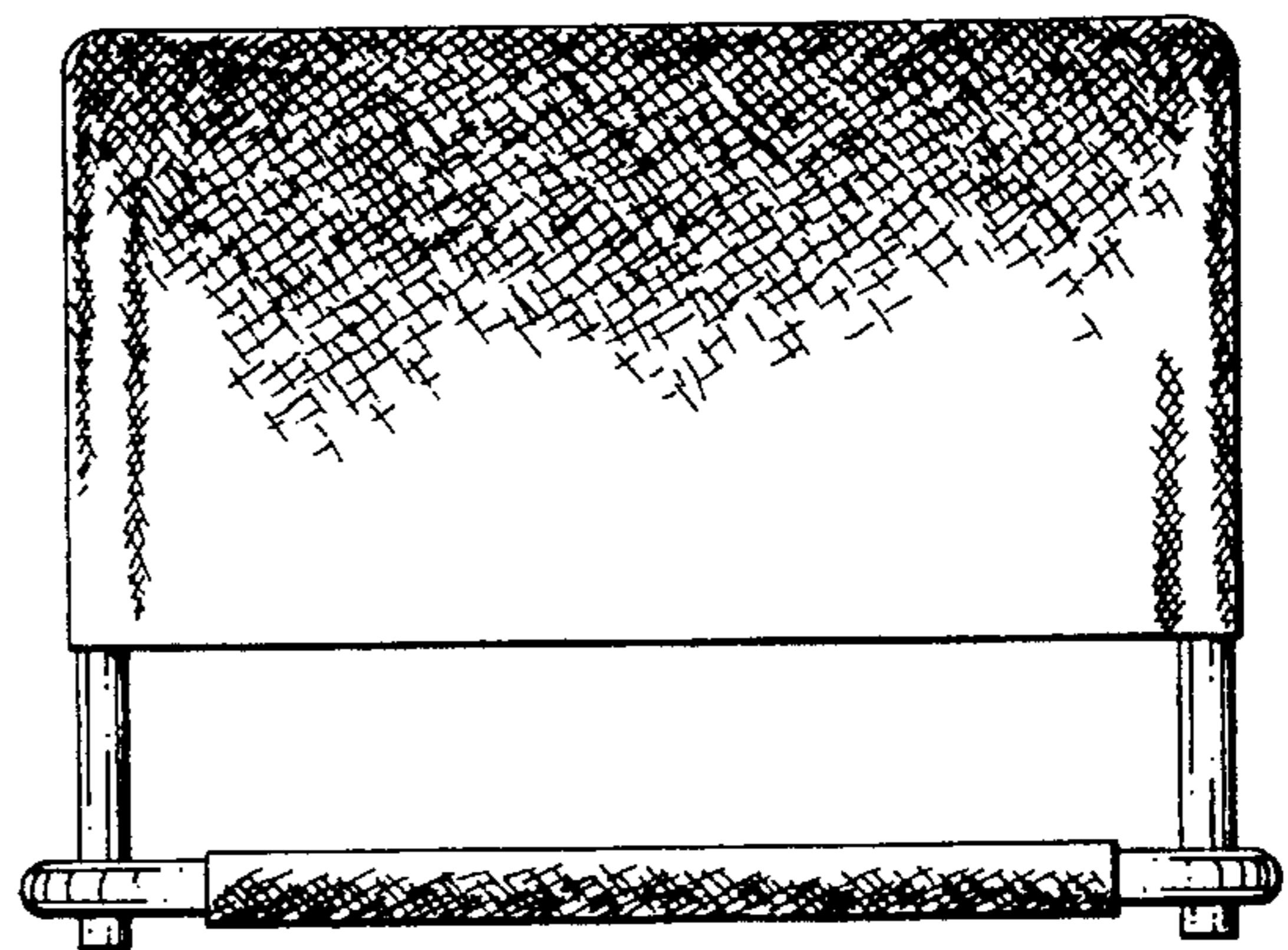

FIG. 6

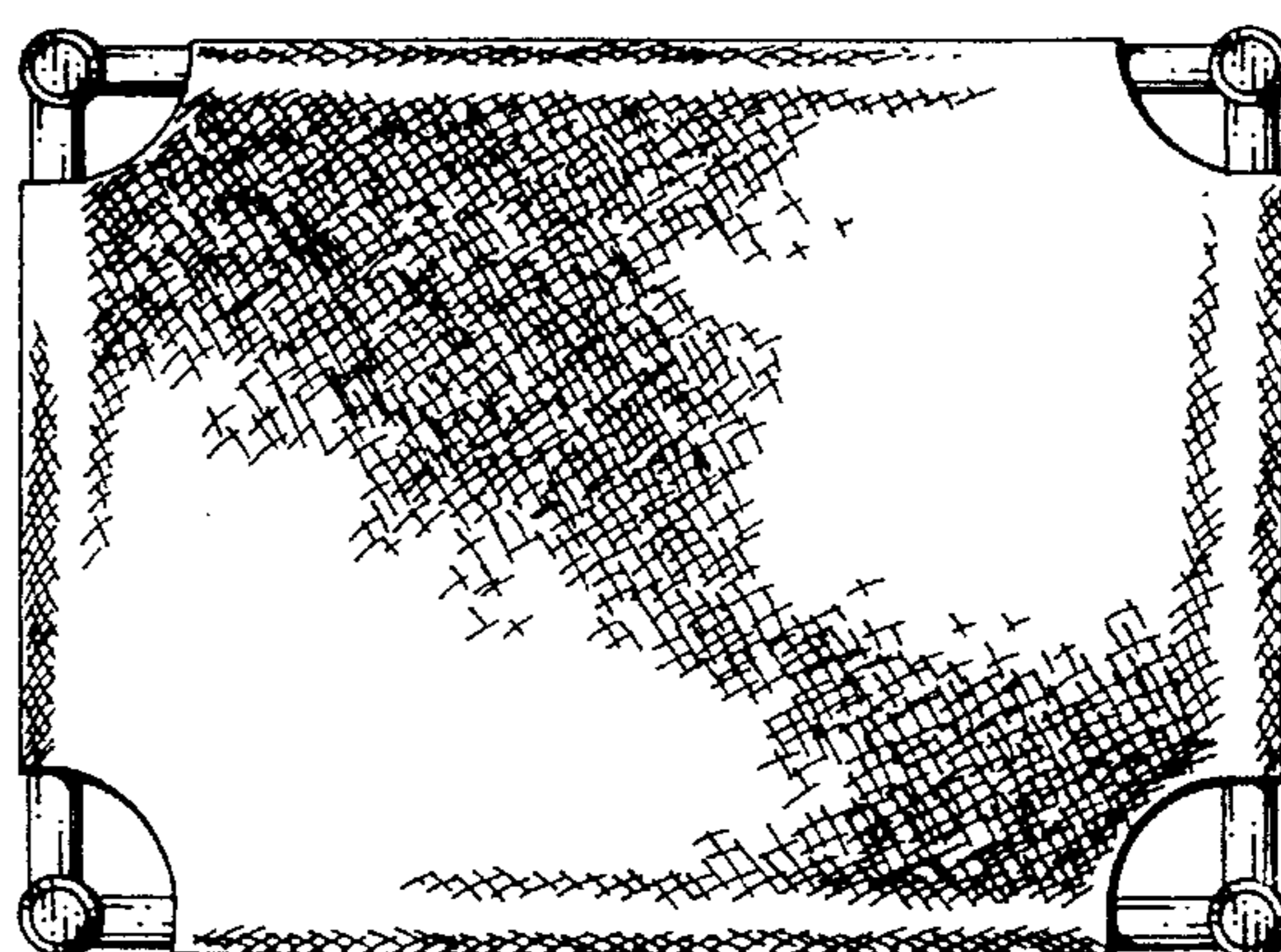
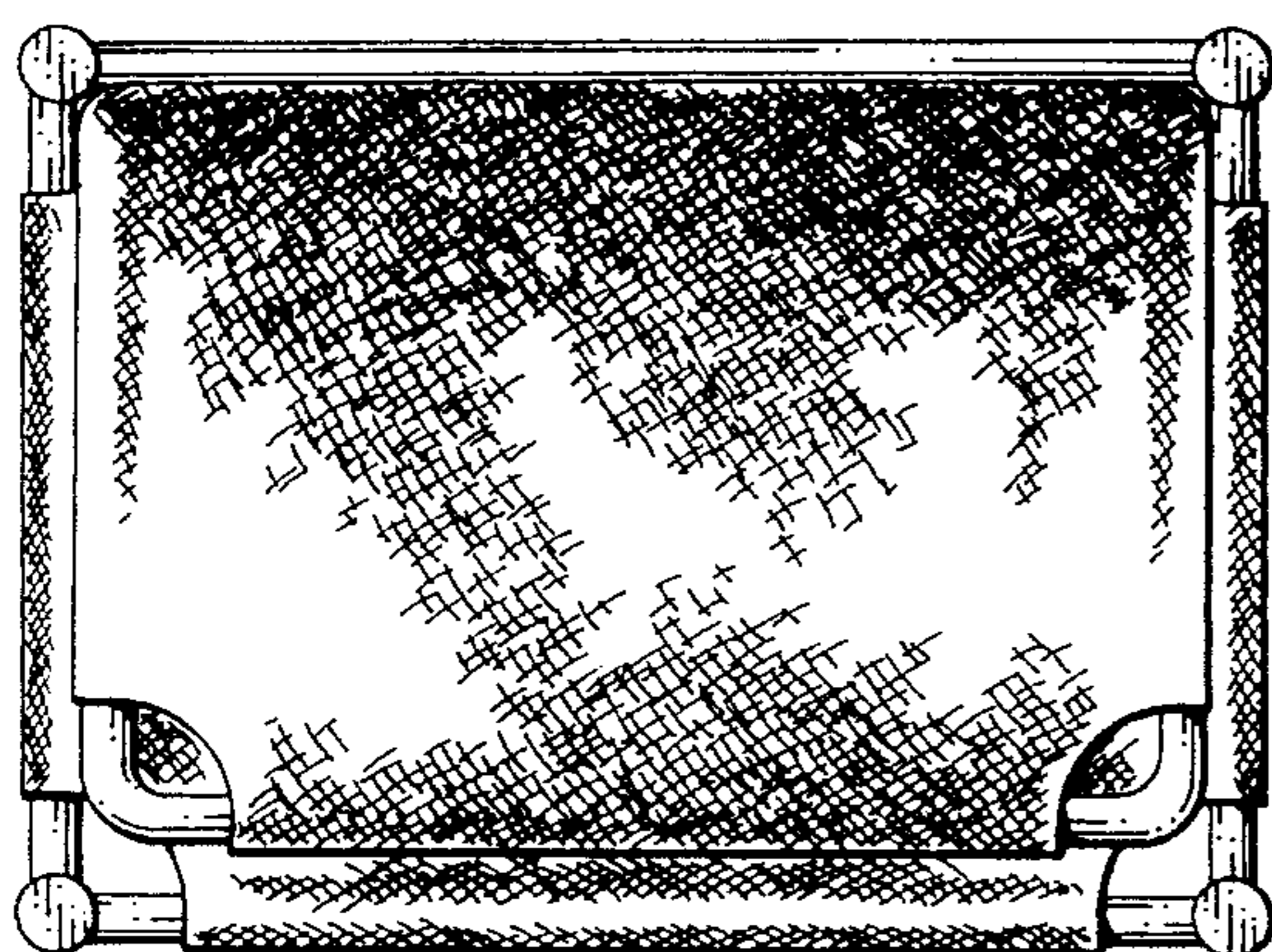
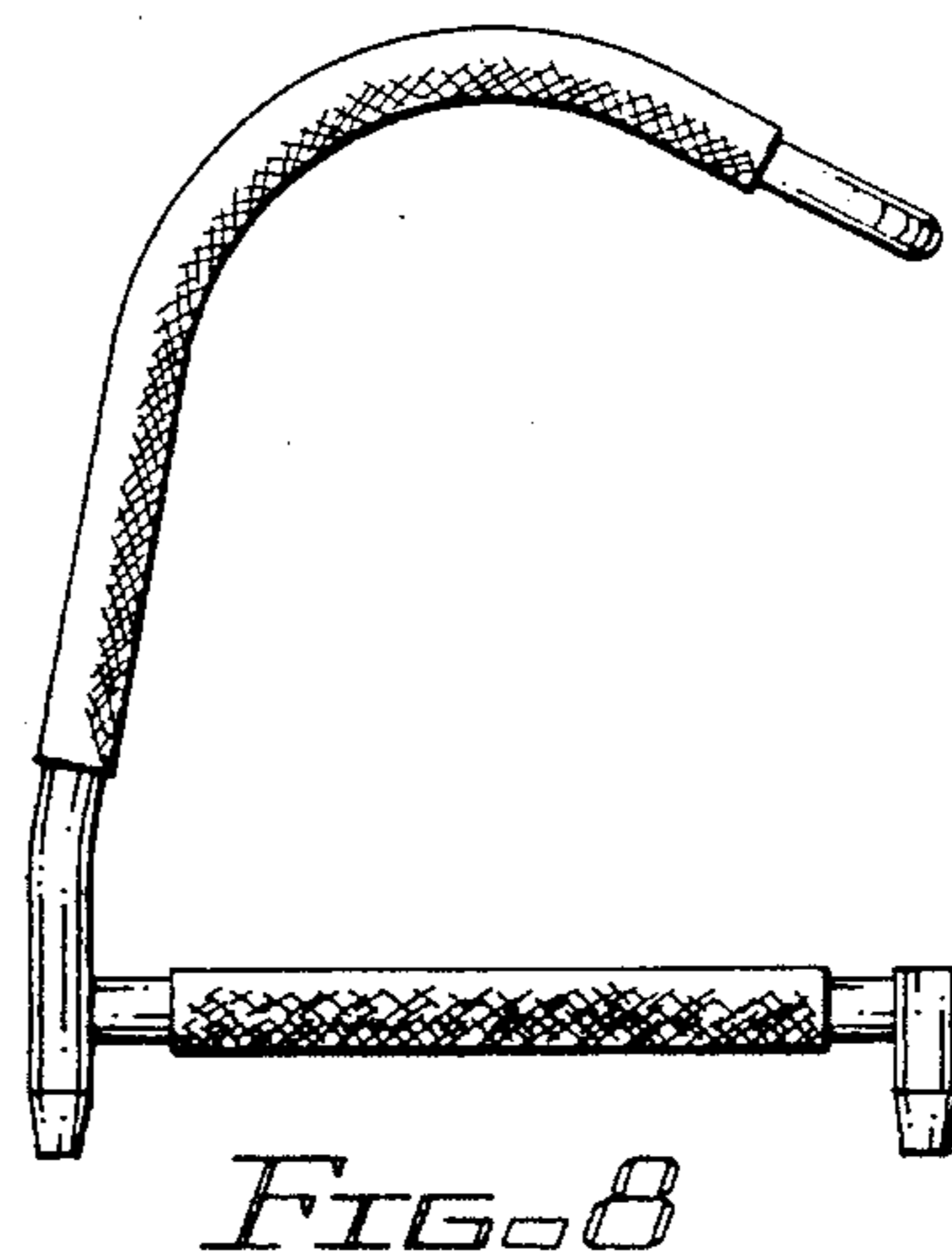
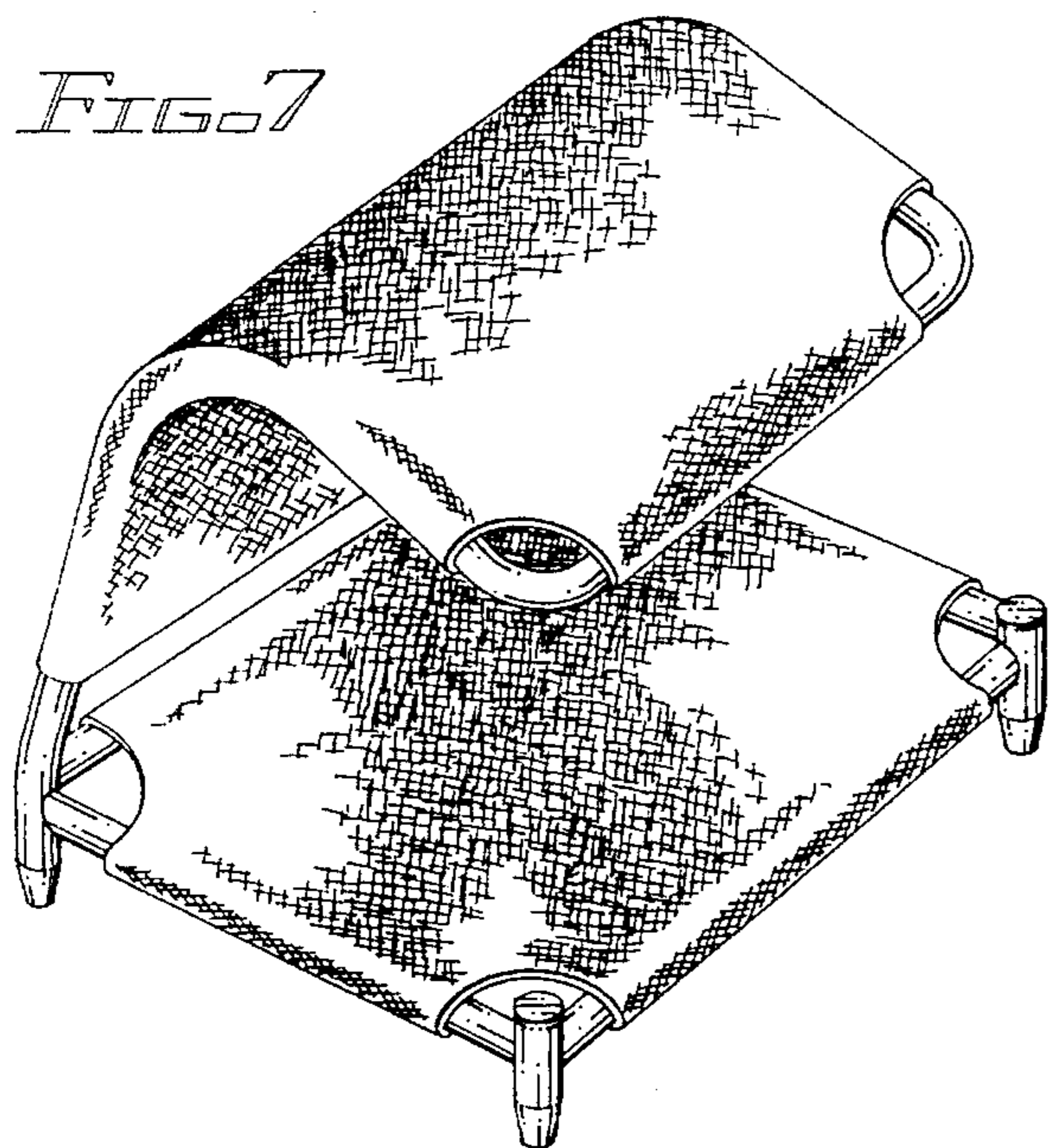

FIG. 9

FIG. 10

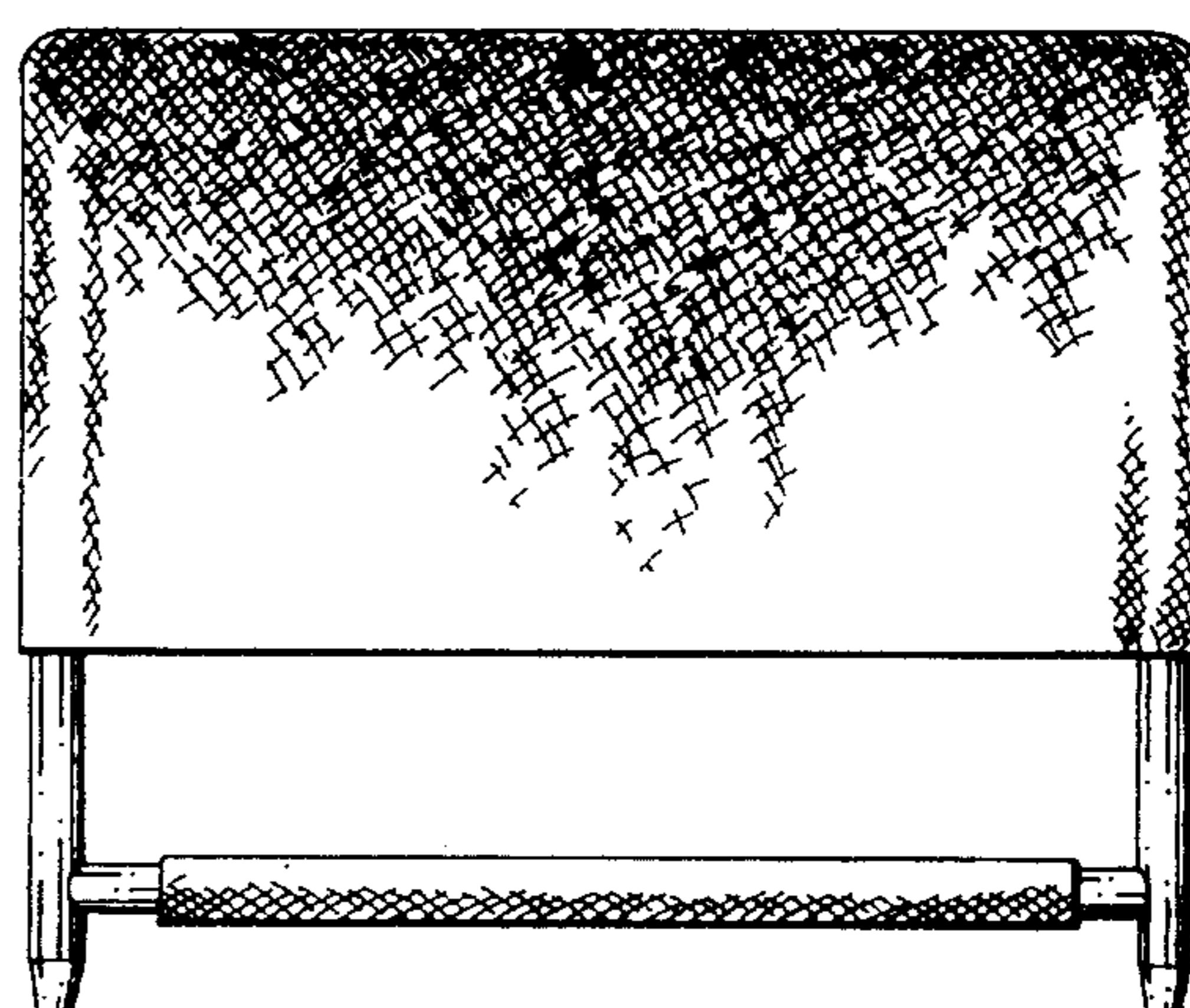
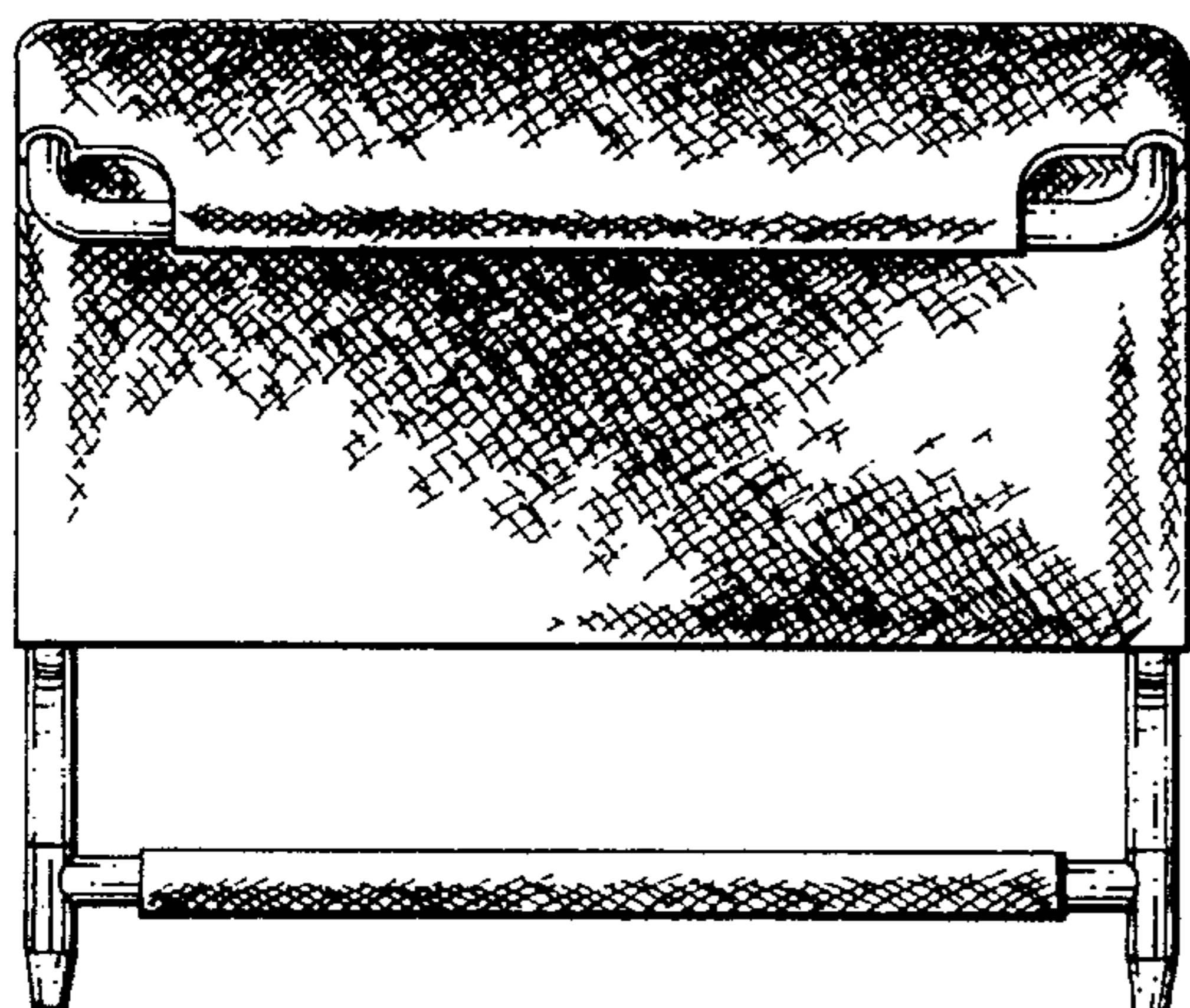

FIG. 11

FIG. 12