



US00D374466S

United States Patent [19]

Guegan et al.

[11] Patent Number: **Des. 374,466**

[45] Date of Patent: ****Oct. 8, 1996**

[54] **FIGURINE SHAPED SCREWDRIVER FOR TOYS**

3,173,462 3/1965 Koepfel .
4,551,110 11/1985 Selvage et al. .
5,108,336 4/1992 Rosher 446/144

[75] Inventors: **Jacques Guegan**, L'Hay les Roses;
Francis Lecocq, Hames-Boucres;
Jean-Pierre Moussaud, Les Attaques;
Jean-Jacques Urvoy, Paris; **Valerie Gautier**, Paris; **Francis Bance**, Paris,
all of France

Primary Examiner—Raphael Barkai
Attorney, Agent, or Firm—Pennie & Edmonds

[57] CLAIM

The ornamental design for a figurine shaped screwdriver for toys, as shown and described.

[73] Assignee: **Meccano S.A.**, France

DESCRIPTION

[**] Term: **14 Years**

FIG. 1 is a perspective view of a figurine shaped screwdriver for toys showing our new design;
FIG. 2 is a front view thereof;
FIG. 3 is a rear view thereof;
FIG. 4 is a right side view thereof, the left side view thereof being a mirror image thereof;
FIG. 5 is a top view thereof;
FIG. 6 is a bottom view thereof;
FIG. 7 is a perspective view of the screwdriver of FIG. 1 with its cap removed;
FIG. 8 is a front view thereof;
FIG. 9 is a top view thereof;
FIG. 10 is a right side view thereof;
FIG. 11 is a rear view thereof;
FIG. 12 is a bottom view thereof; and,
FIG. 13 is a left side view thereof.

[21] Appl. No.: **23,897**

[22] Filed: **Jun. 2, 1994**

[52] U.S. Cl. **D21/120; D21/166**

[58] Field of Search **D21/120, 166;**
D8/82, 83, 107; 446/144, 86

[56] References Cited

U.S. PATENT DOCUMENTS

D. 210,471	3/1968	Aoix	D21/166
D. 255,813	7/1980	Pape et al.	D21/166
D. 265,544	7/1982	Nelson .	
D. 277,119	1/1985	Paczko	D21/120
D. 303,920	10/1989	Kandel .	
D. 341,172	11/1993	Olsen .	
D. 352,078	11/1994	Bertrand	D21/166
2,672,707	3/1954	Greenhaus	446/144

1 Claim, 4 Drawing Sheets

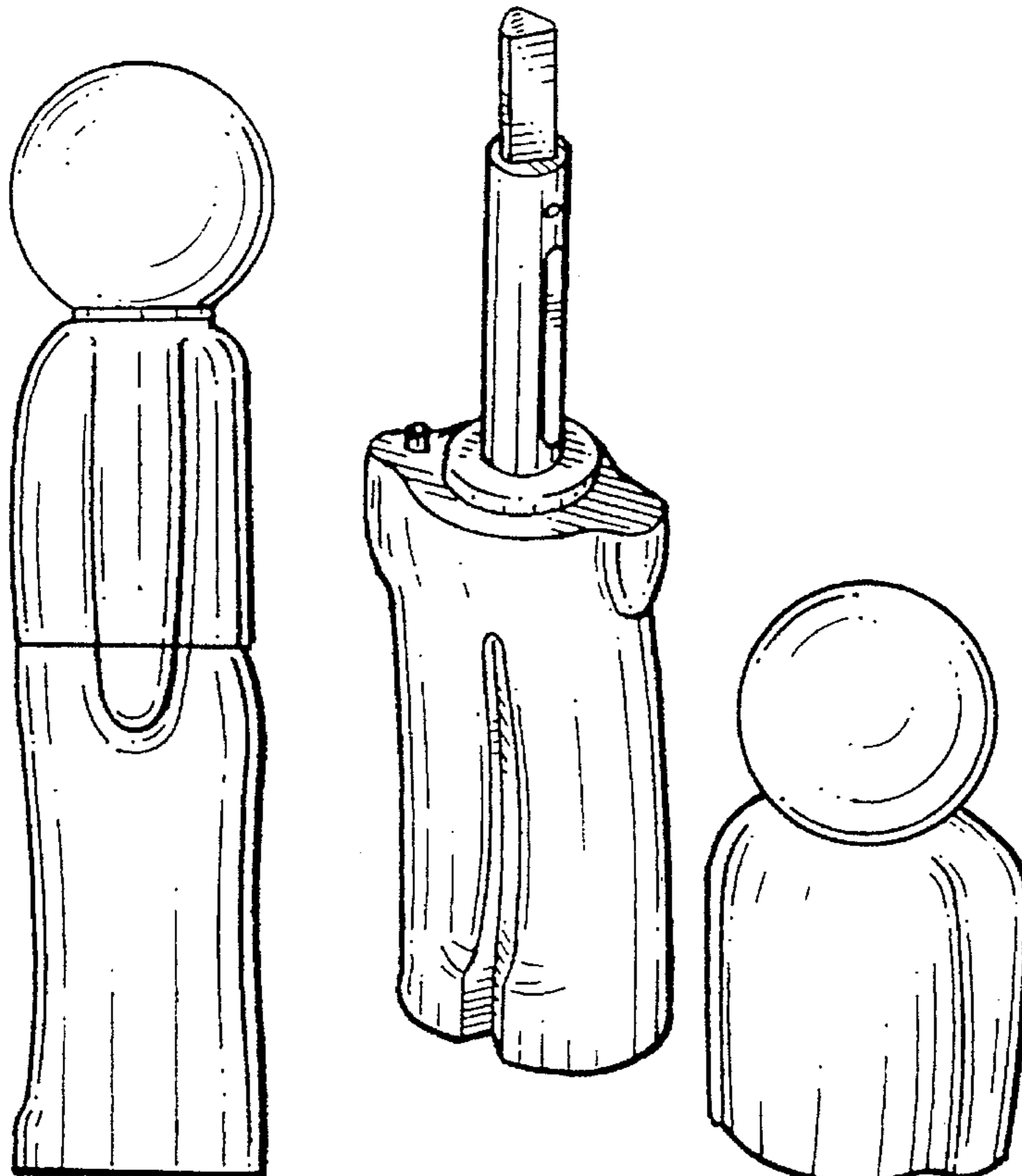

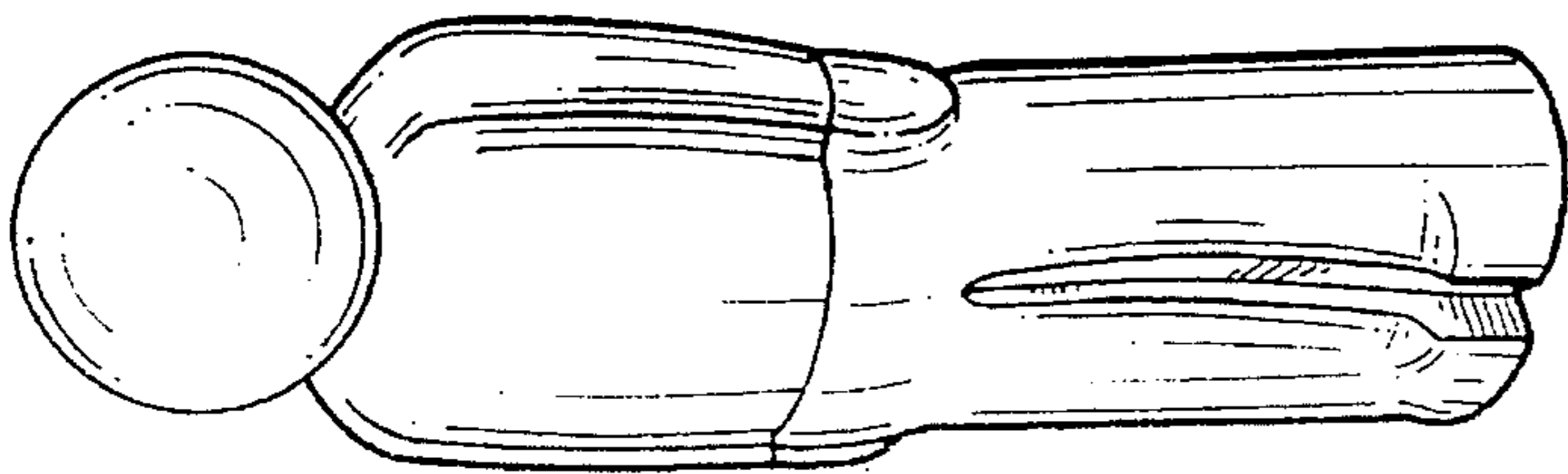

FIG. 1

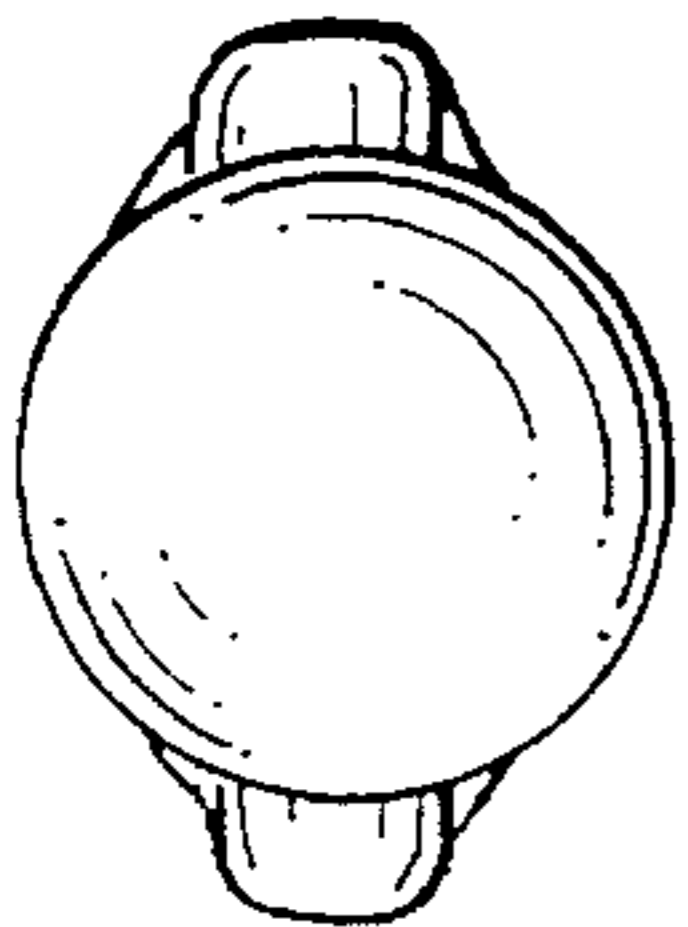

FIG. 5

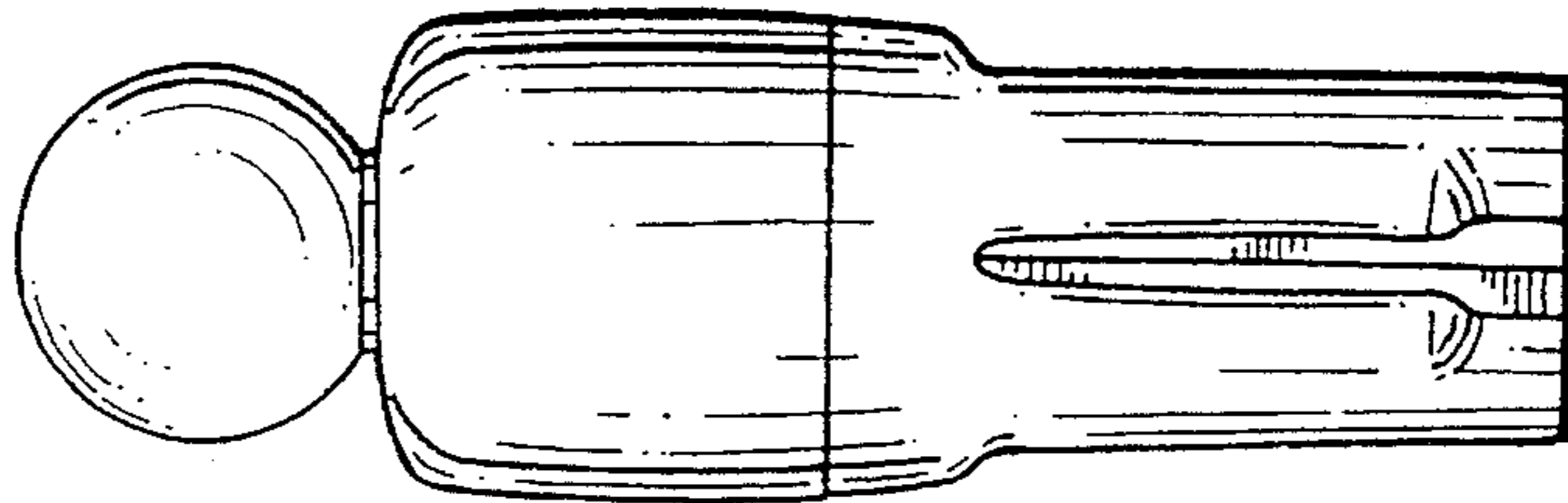

FIG. 2

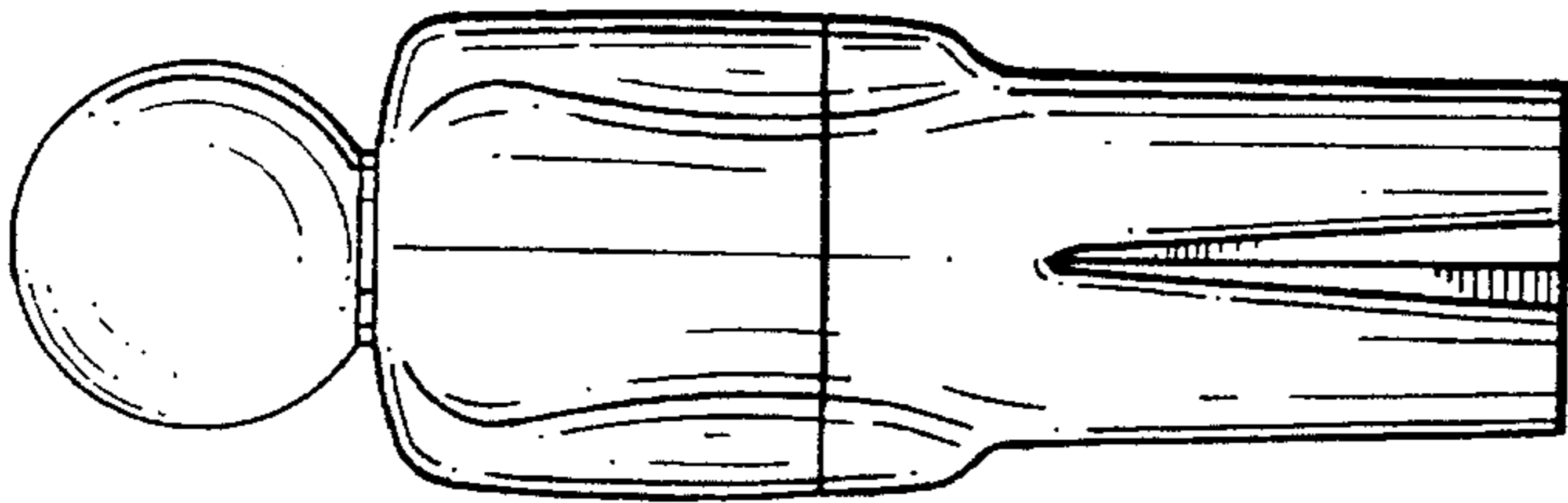

FIG. 3

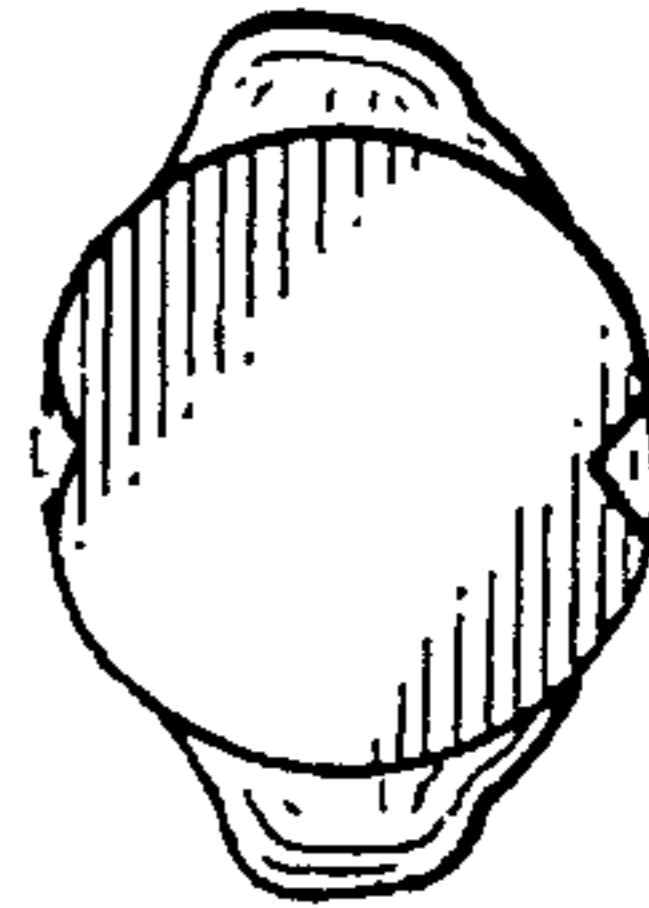

FIG. 6

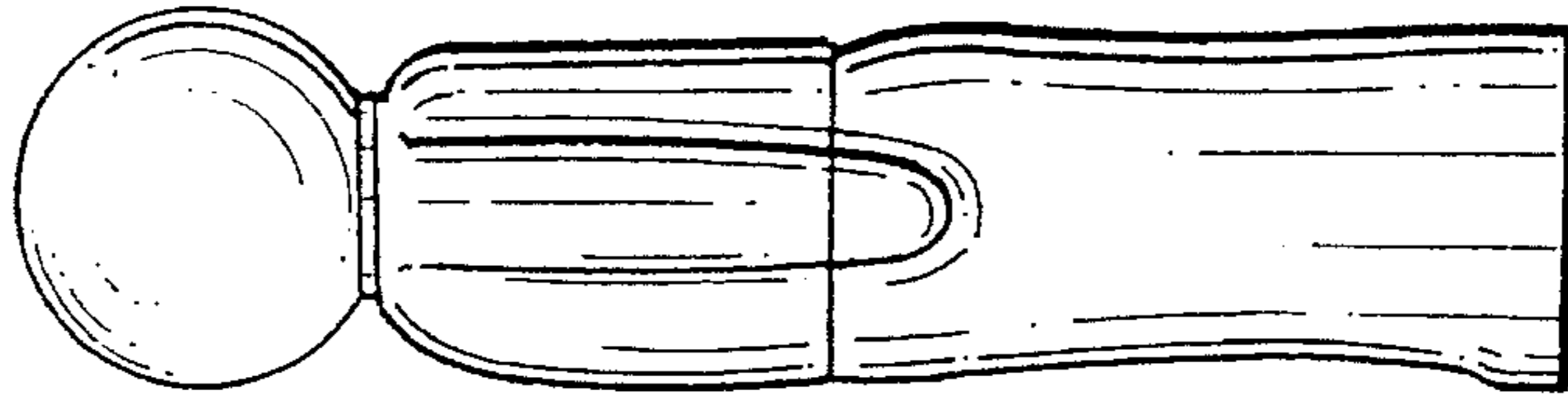

FIG. 4

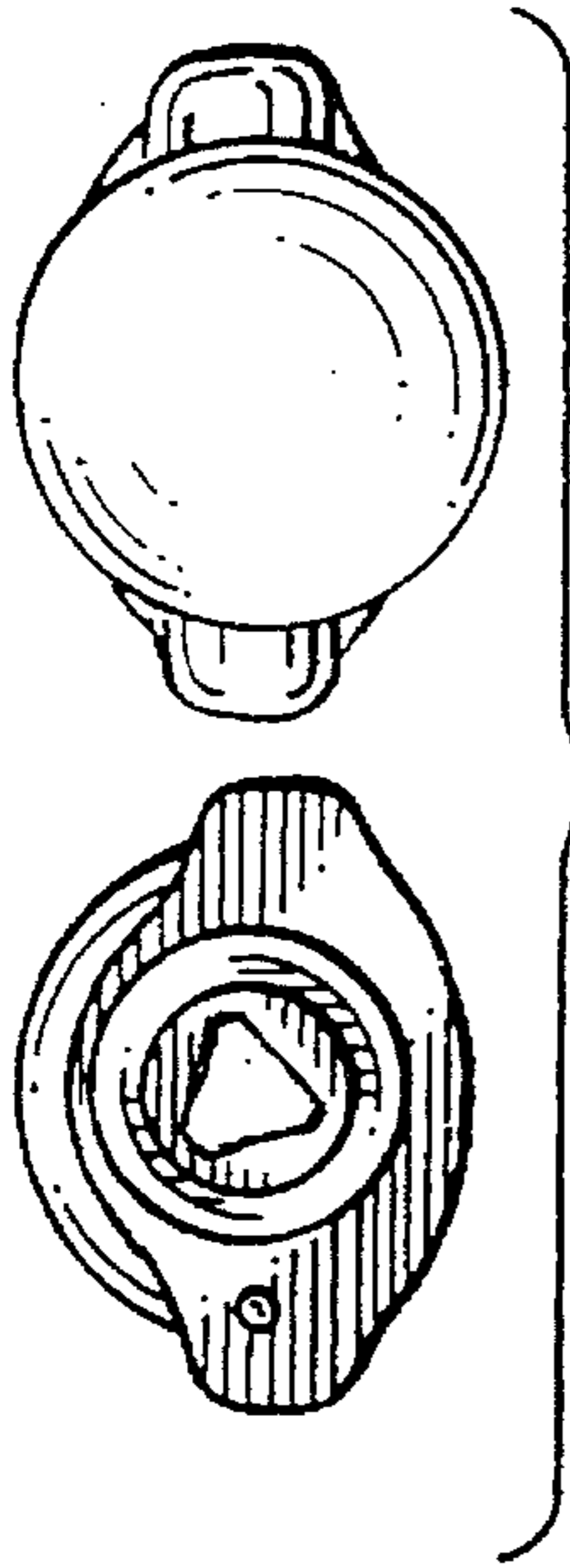

FIG. 9

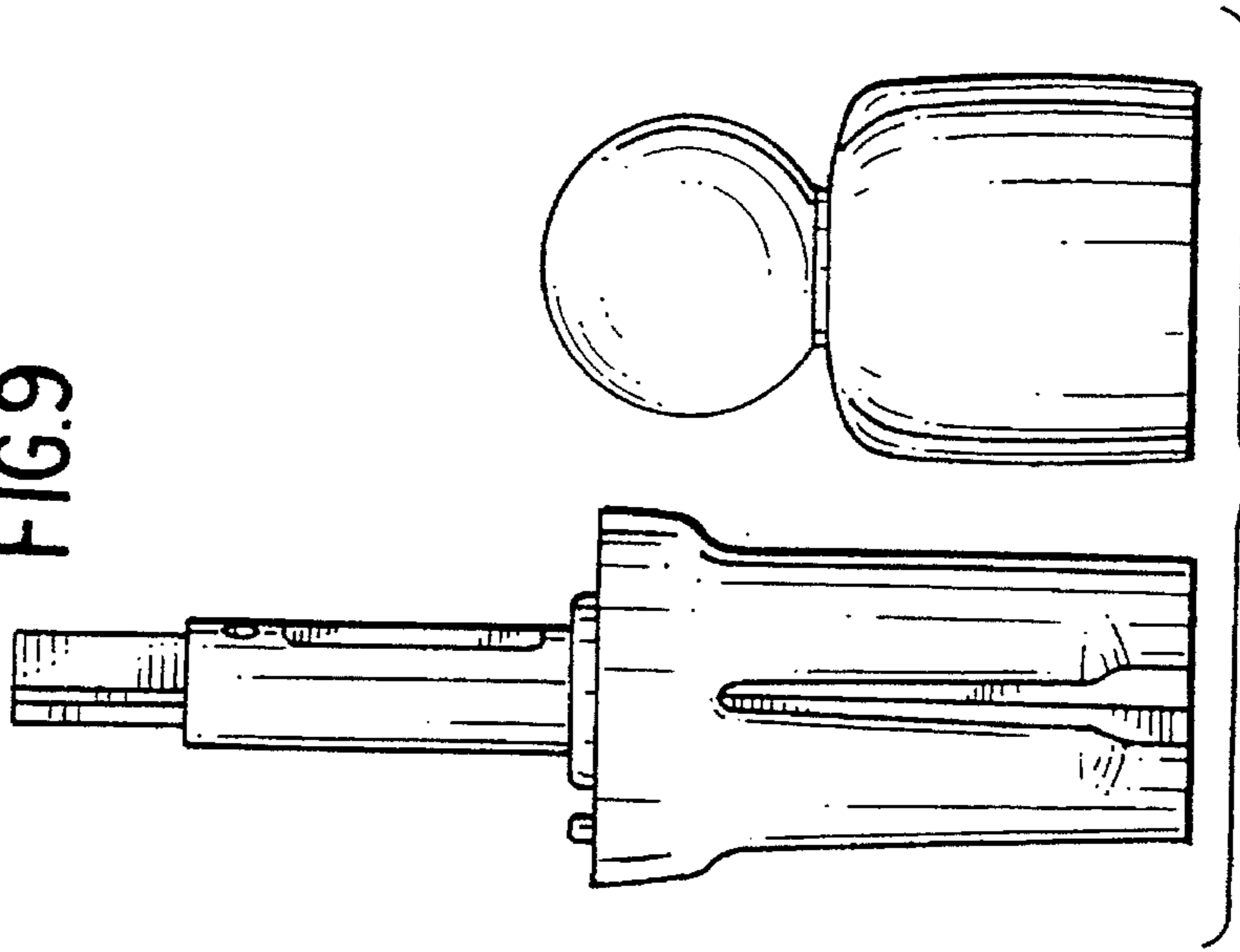

FIG. 8

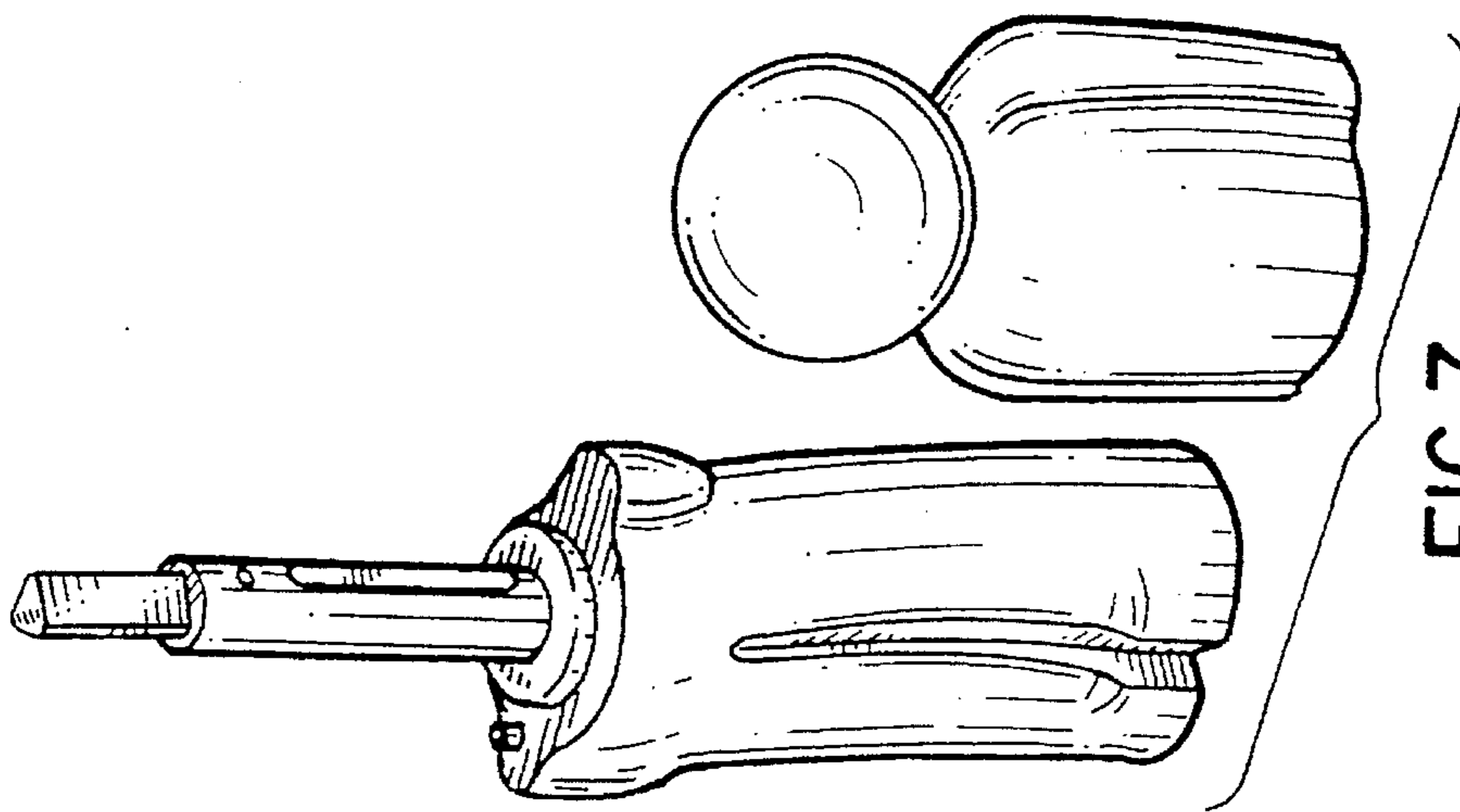

FIG. 7

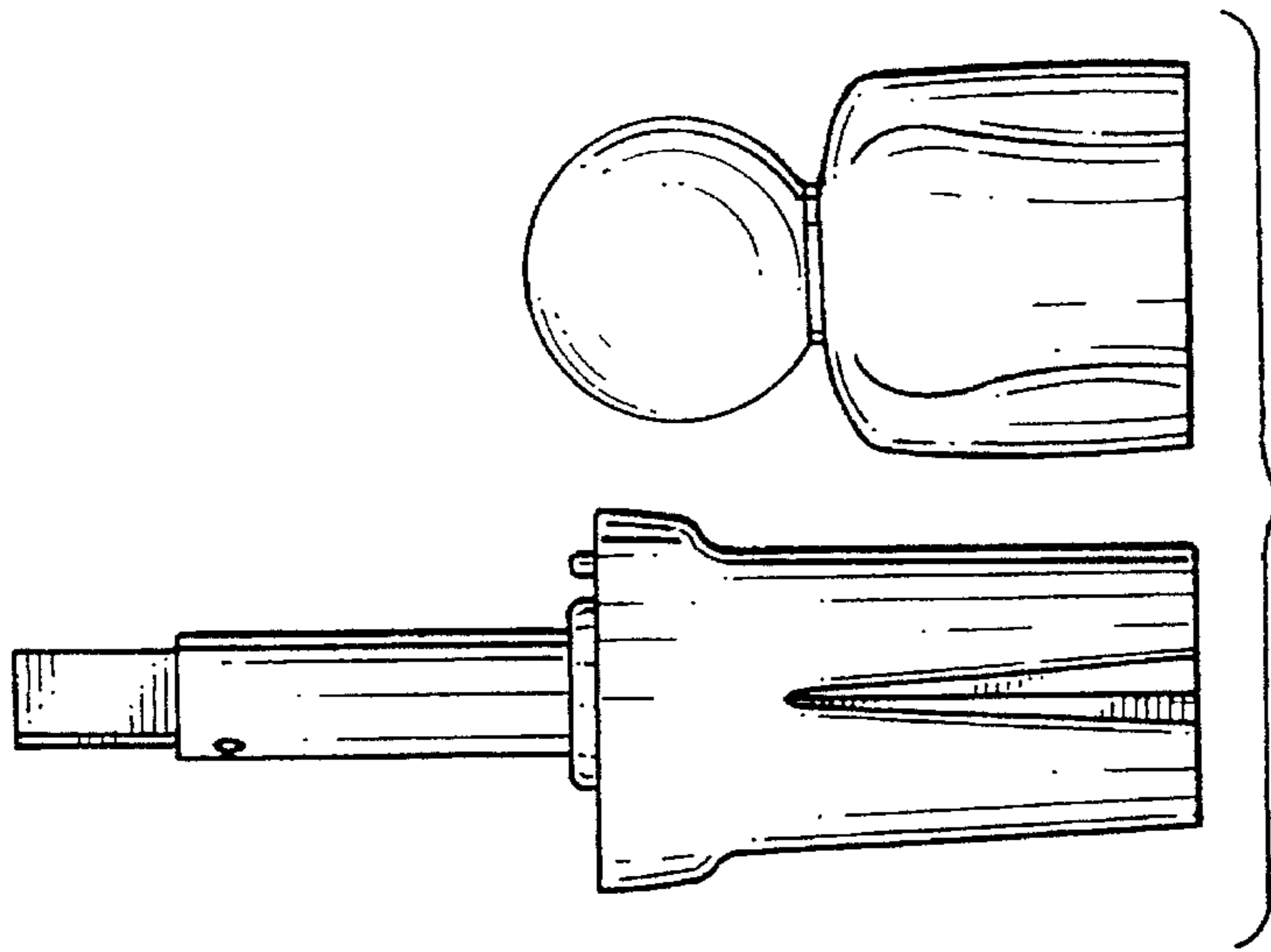

FIG. 11

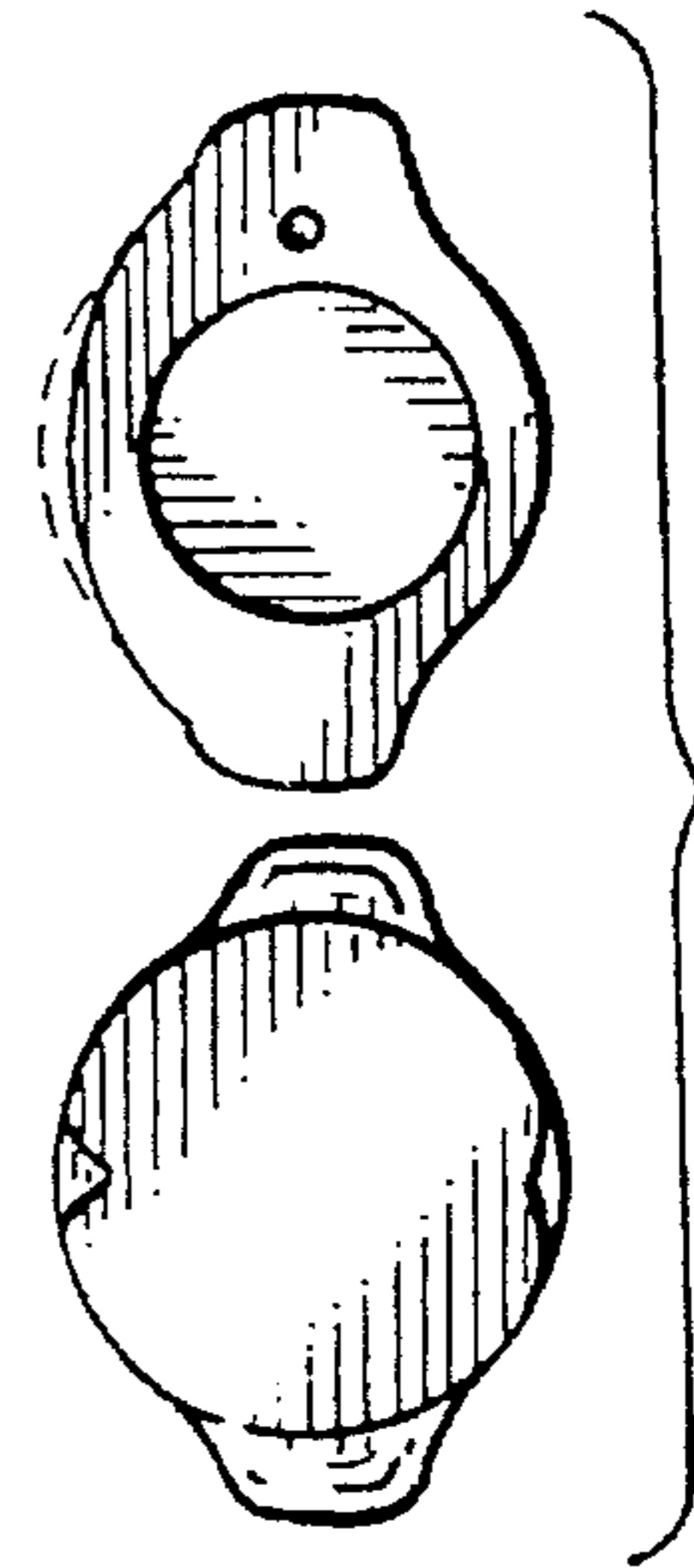

FIG. 12

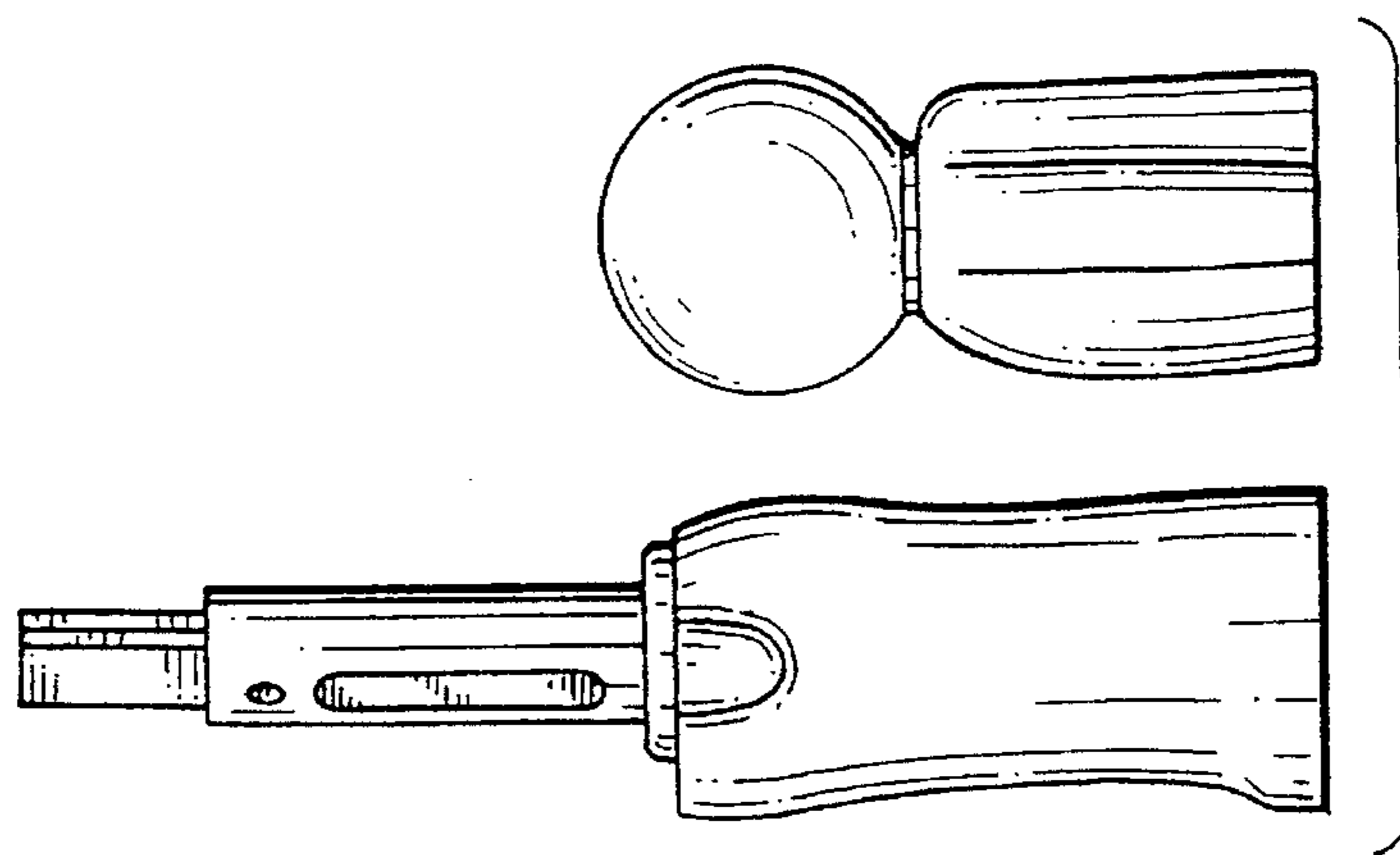

FIG. 10

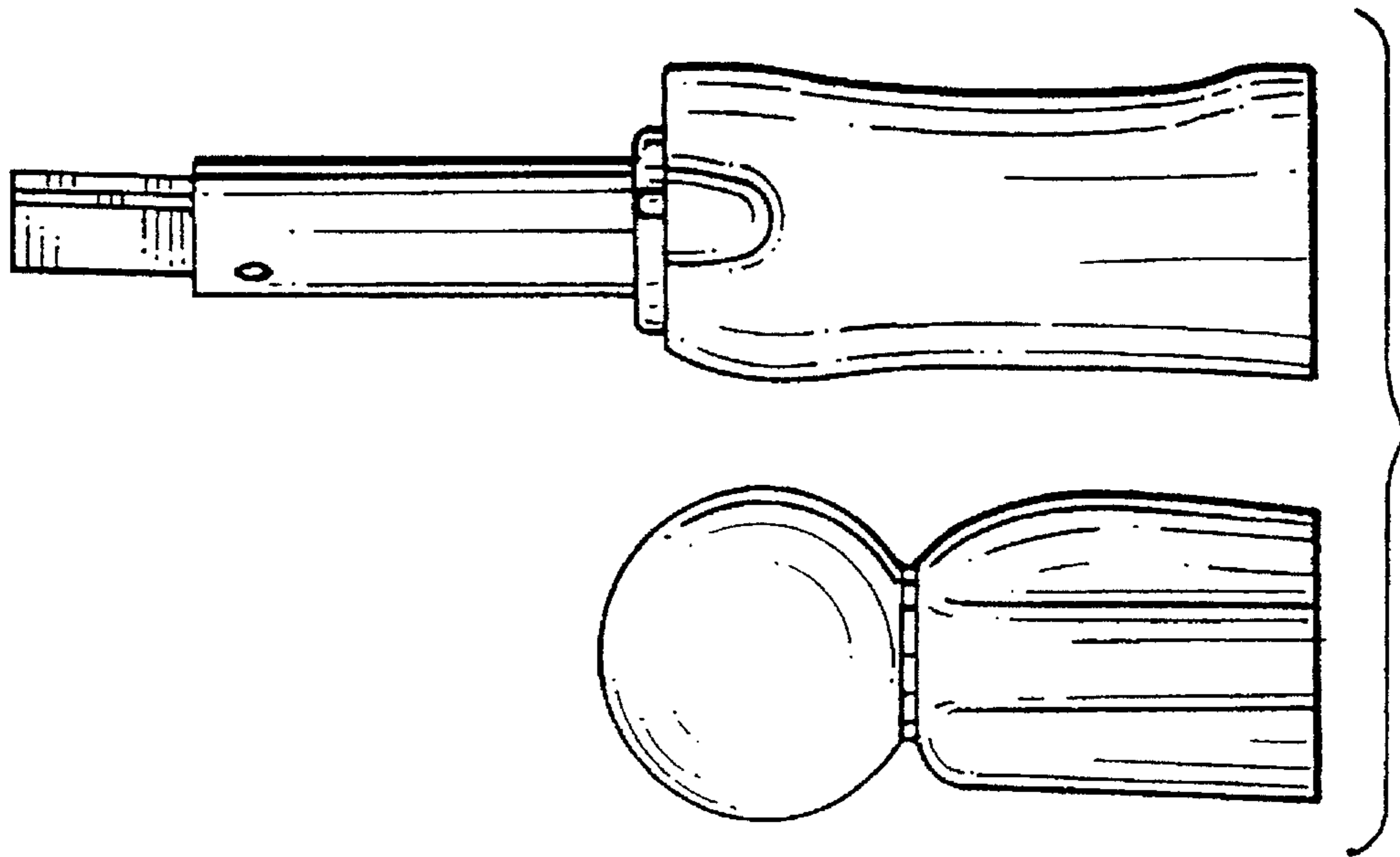

FIG.13