



US00D374298S

United States Patent [19]

[11] Patent Number: **Des. 374,298**

Swyst

[45] Date of Patent: ****Oct. 1, 1996**

[54] **LIGHT WITH FLEXIBLE BODY**

4,864,477 9/1989 Engelman 362/376

[75] Inventor: **Thomas Swyst**, Arlington, Mass.

Primary Examiner—A. Hugo Word

[73] Assignee: **Black & Decker Inc.**, Newark, Del.

Assistant Examiner—Lavone D. Tabor

[**] Term: **14 Years**

Attorney, Agent, or Firm—Barry E. Deutsch

[21] Appl. No.: **36,288**

[57] **CLAIM**

The ornamental design for a light with flexible body, as shown and described.

[22] Filed: **Mar. 16, 1995**

[52] U.S. Cl. **D26/43**

DESCRIPTION

[58] **Field of Search** D26/37, 43, 44,
D26/46, 49, 60, 62; 362/157, 158, 184,
188, 189, 191, 198, 199, 200, 202, 362,
376-378, 396

FIG. 1 is a perspective view taken from the front, top and right side of a light with flexible body;
FIG. 2 is a right side elevational view thereof;
FIG. 3 is a left side elevational view thereof;
FIG. 4 is a front elevational view thereof;
FIG. 5 is a rear elevational view thereof;
FIG. 6 is a top plan view thereof; and,
FIG. 7 is a bottom plan view thereof.

[56] References Cited

U.S. PATENT DOCUMENTS

D. 152,584	2/1949	Becker	D26/43
D. 290,519	6/1987	Kuo	D26/60
D. 298,657	11/1988	Flores	D26/37
D. 314,246	1/1991	Bache	D26/62
4,141,062	2/1979	Trueblood	362/378 X

The broken lines showing of a light bulb are for illustrative purposes only and forms no part of the claimed design.

1 Claim, 3 Drawing Sheets

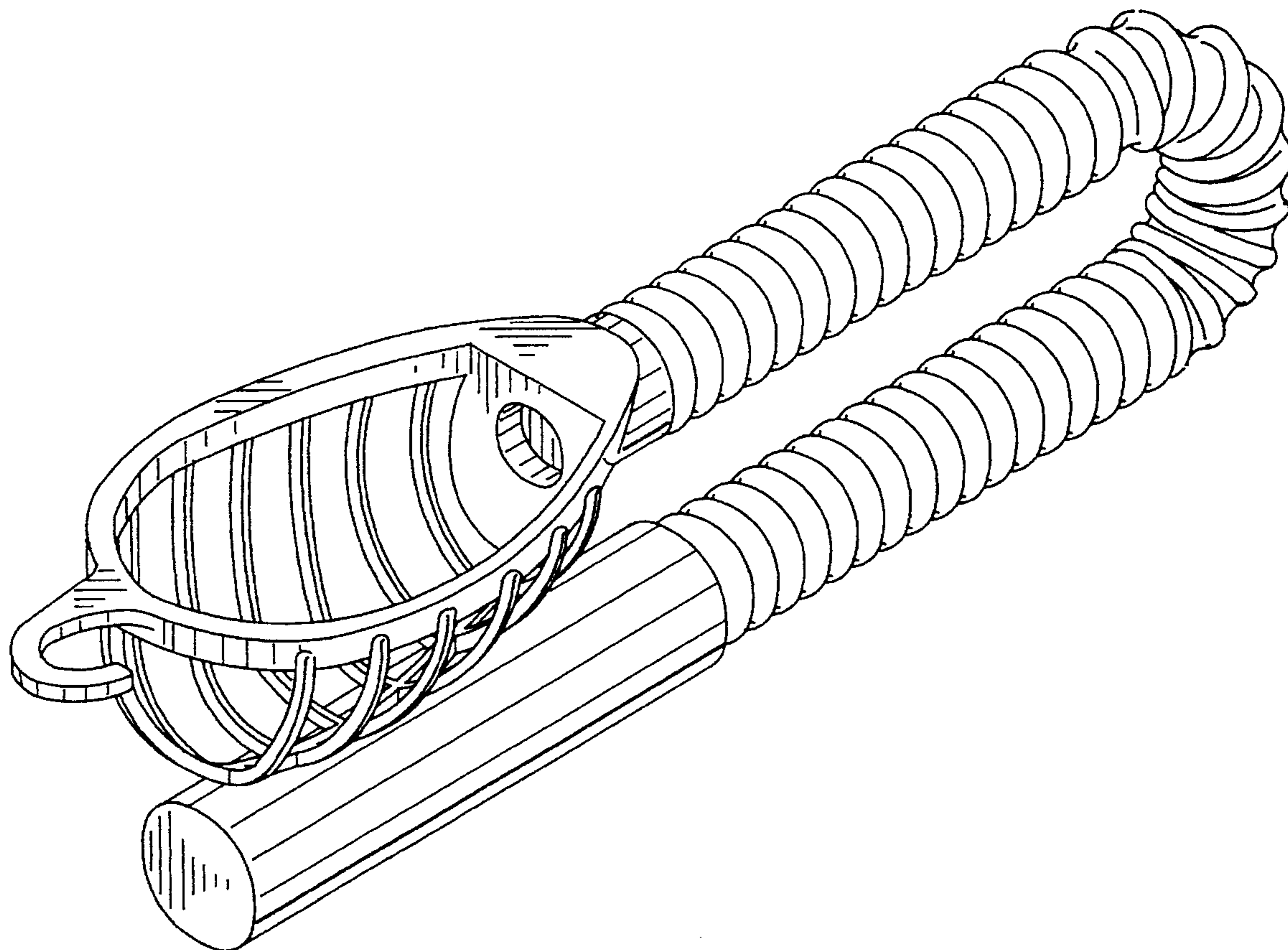

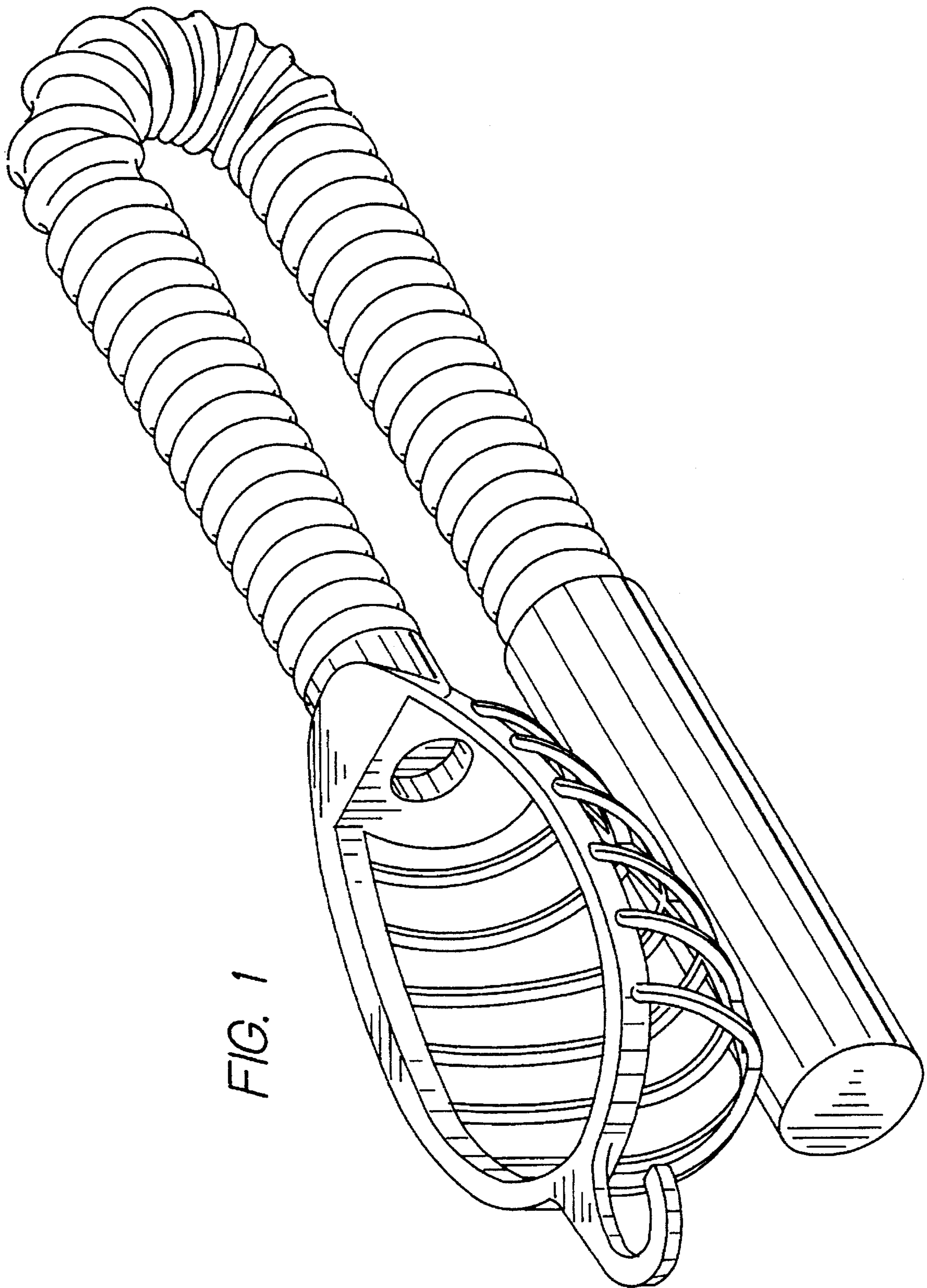

FIG. 1

FIG. 2

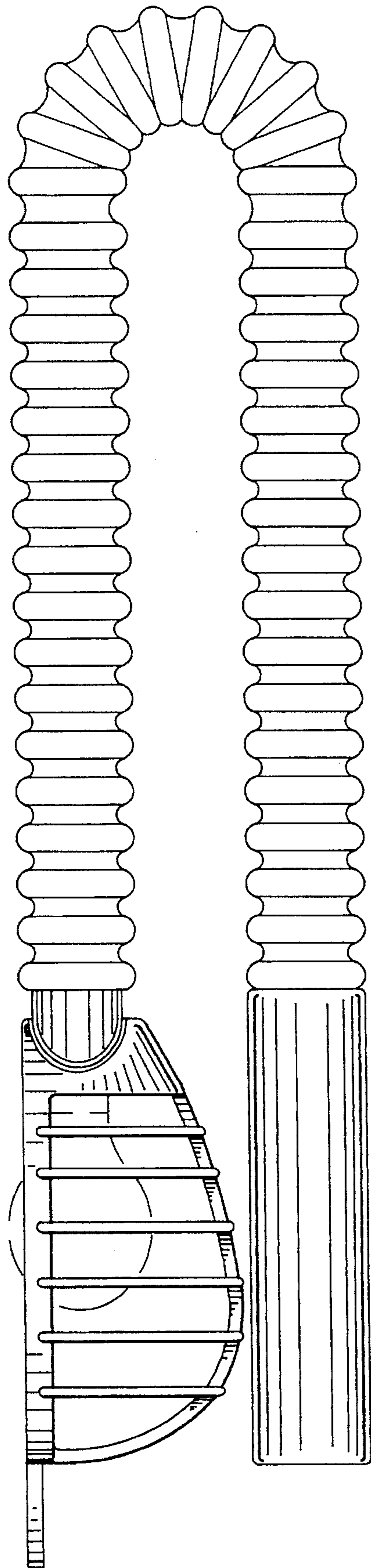

FIG. 3

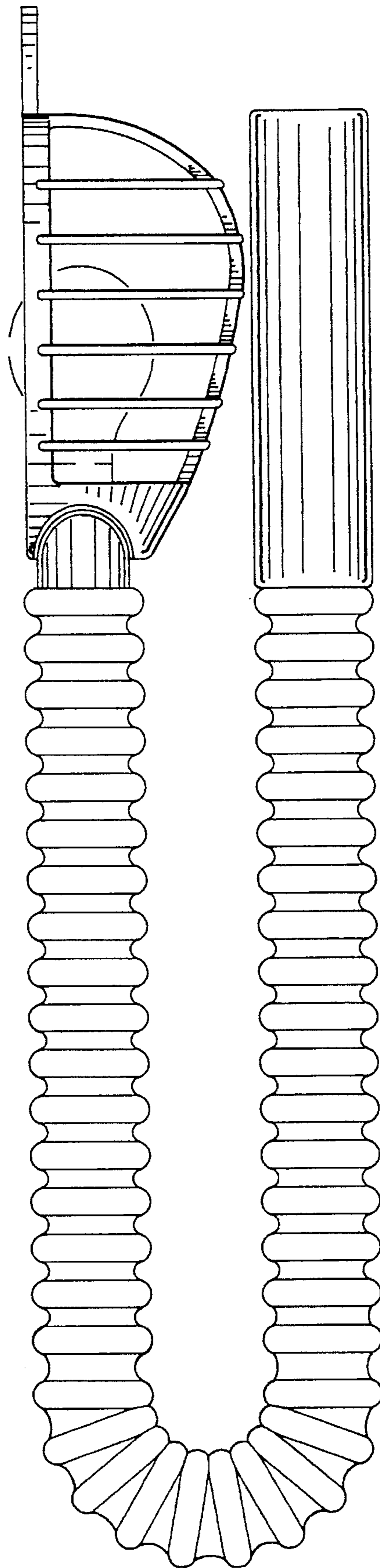

FIG. 5

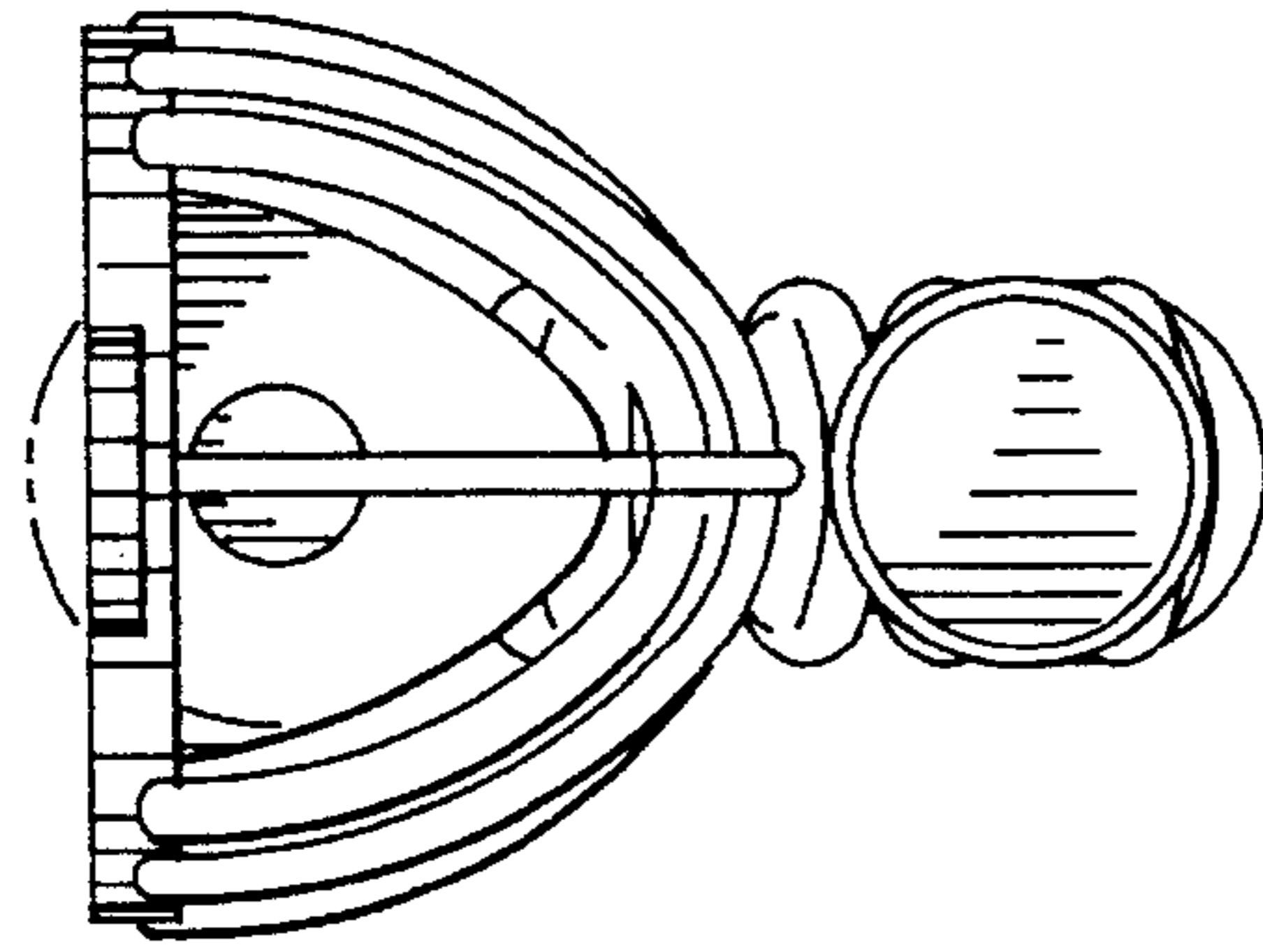
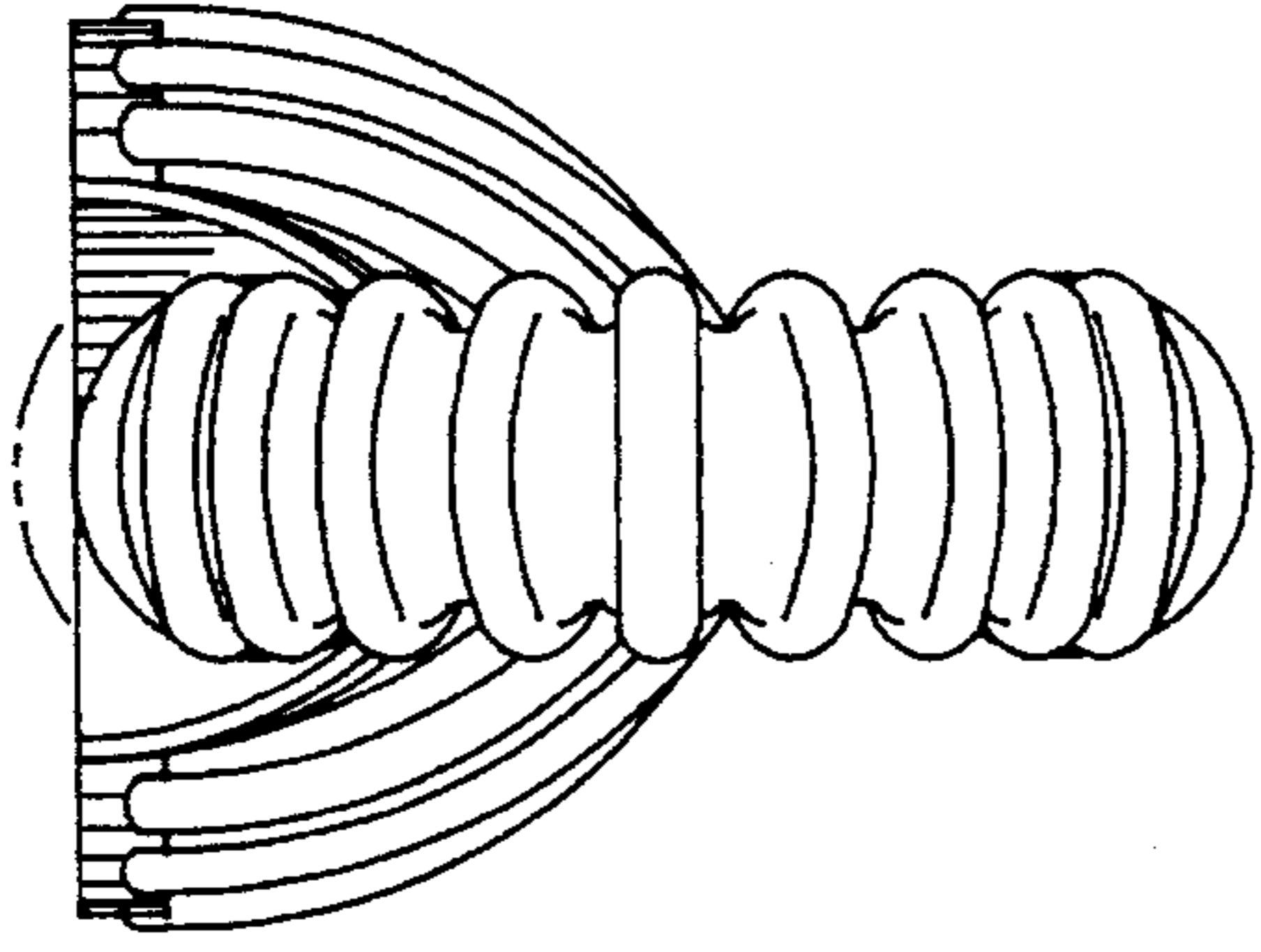

FIG. 4

FIG. 6

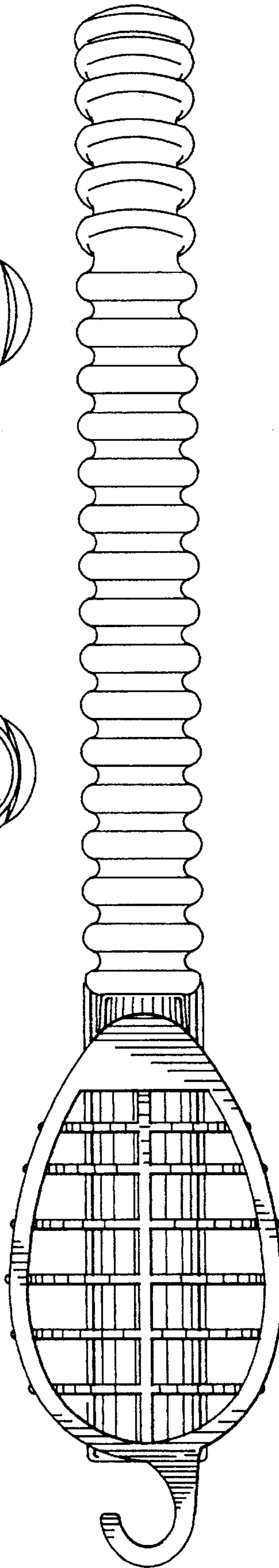

FIG. 7

