



US00D374250S

United States Patent [19]

Yabuki et al.

[11] Patent Number: **Des. 374,250**

[45] Date of Patent: ****Oct. 1, 1996**

[54] **IMAGE DRUM CARTRIDGE**
[75] Inventors: **Makoto Yabuki; Takashi Itaya; Minoru Mizutani**, all of Tokyo, Japan

[73] Assignee: **Oki Data Corporation**, Tokyo, Japan

[**] Term: **14 Years**

[21] Appl. No.: **41,098**

[22] Filed: **Jul. 6, 1995**

[30] Foreign Application Priority Data

Jan. 9, 1995 [JP] Japan 7-000052

[52] U.S. Cl. **D18/43; D18/40**

[58] Field of Search D18/36, 40, 43; 222/DIG. 1; 355/206, 208, 245, 260, 298

[56] References Cited

U.S. PATENT DOCUMENTS

D. 332,962 2/1993 Kikuchi et al. D18/43

D. 354,980 1/1995 Nakajima et al. D18/43
4,523,615 6/1985 Feenstra et al. 355/260
4,596,455 6/1986 Kohyama et al. 355/260

Primary Examiner—Nelson C. Holtje
Assistant Examiner—Caron D. Veynar
Attorney, Agent, or Firm—Ladas & Parry

[57] CLAIM

The ornamental design for an image drum cartridge, as shown and described.

DESCRIPTION

FIG. 1 is a front view of an embodiment of an image drum cartridge showing our new design; FIG. 2 is a top view of the embodiment of FIG. 1; FIG. 3 is a rear view of the embodiment of FIG. 1; FIG. 4 is a bottom view of the embodiment of FIG. 1; FIG. 5 is a right side view of the embodiment of FIG. 1; FIG. 6 is a left side view of the embodiment of FIG. 1; and FIG. 7 is a perspective view of the embodiment of FIG. 1.

1 Claim, 4 Drawing Sheets

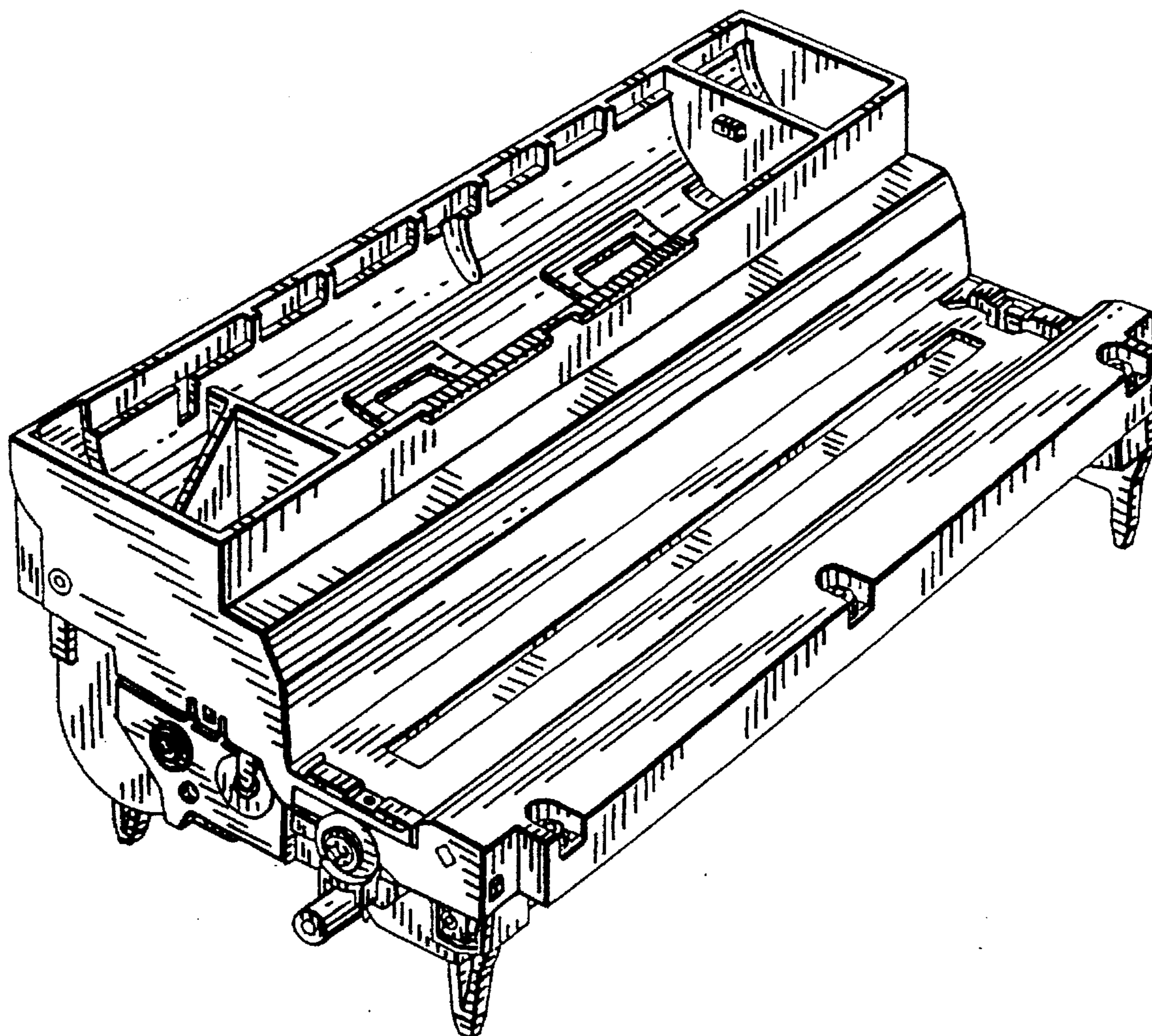

FIG. 1

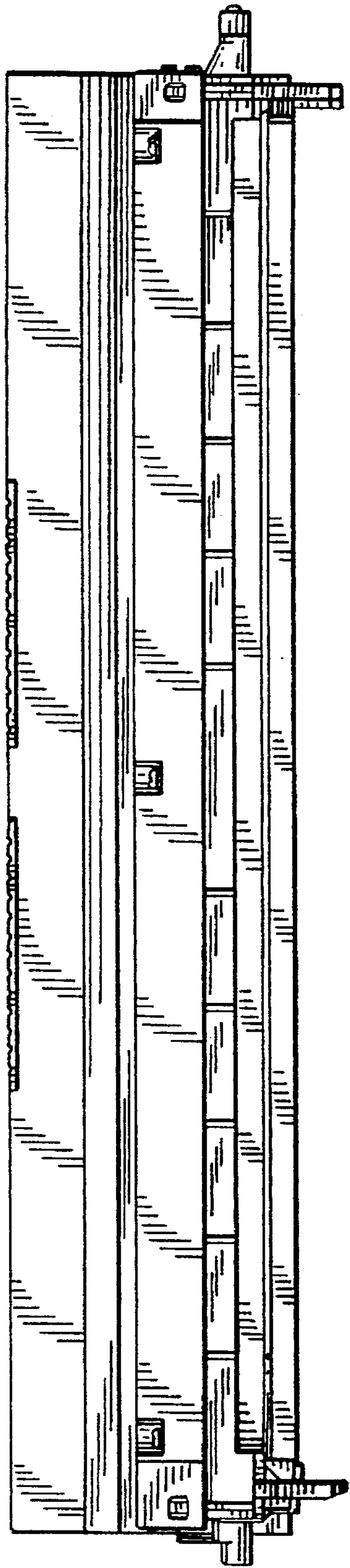

FIG. 2

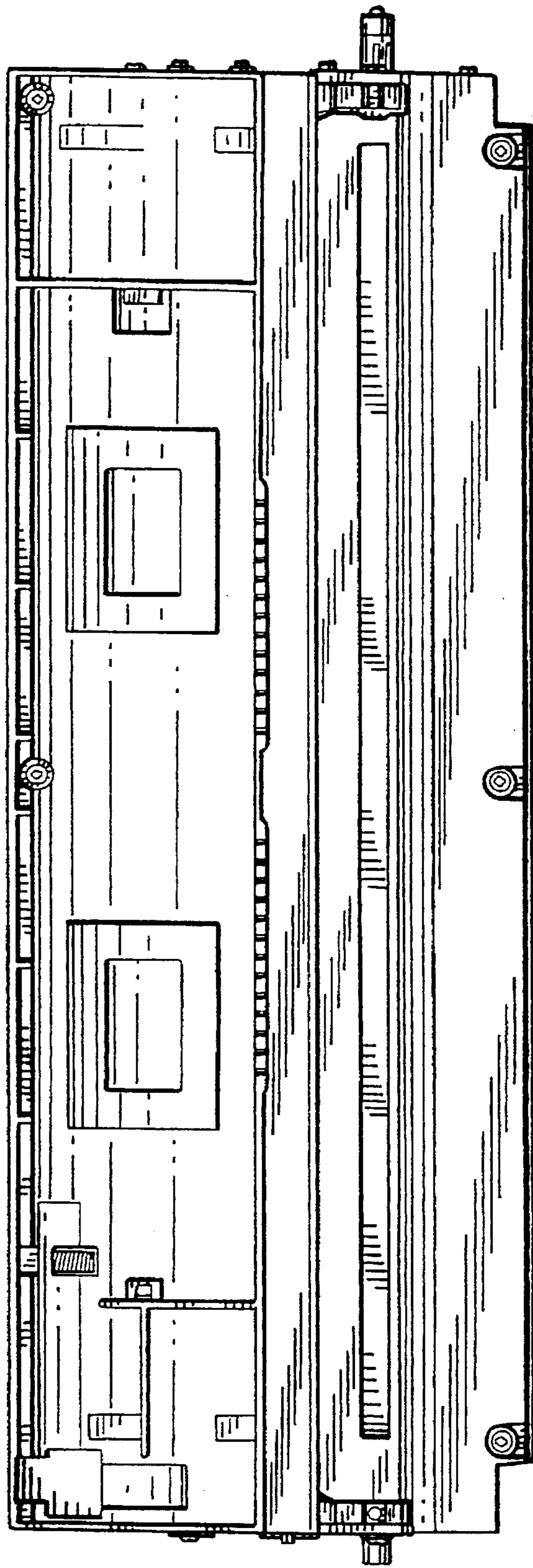

FIG. 3

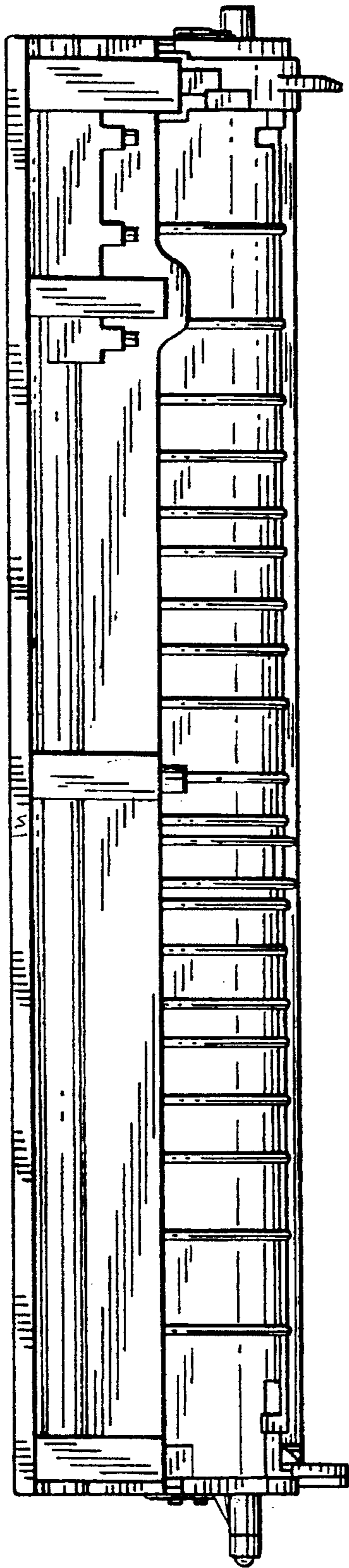

FIG. 4

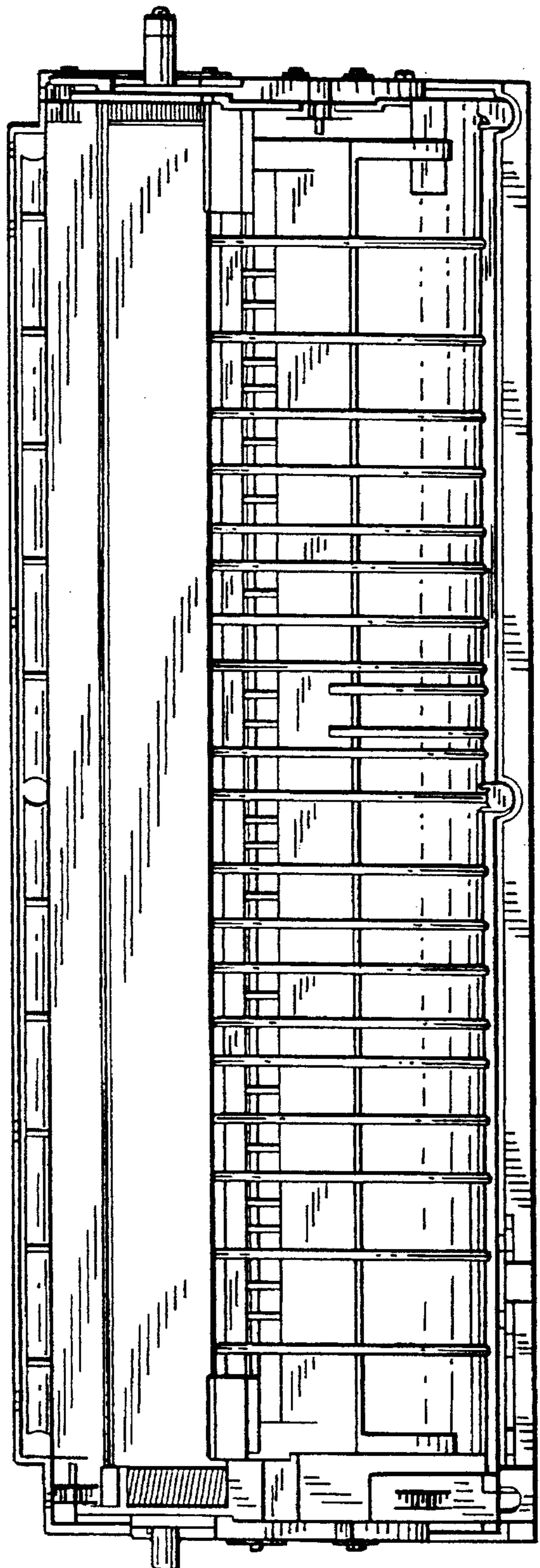

FIG. 5

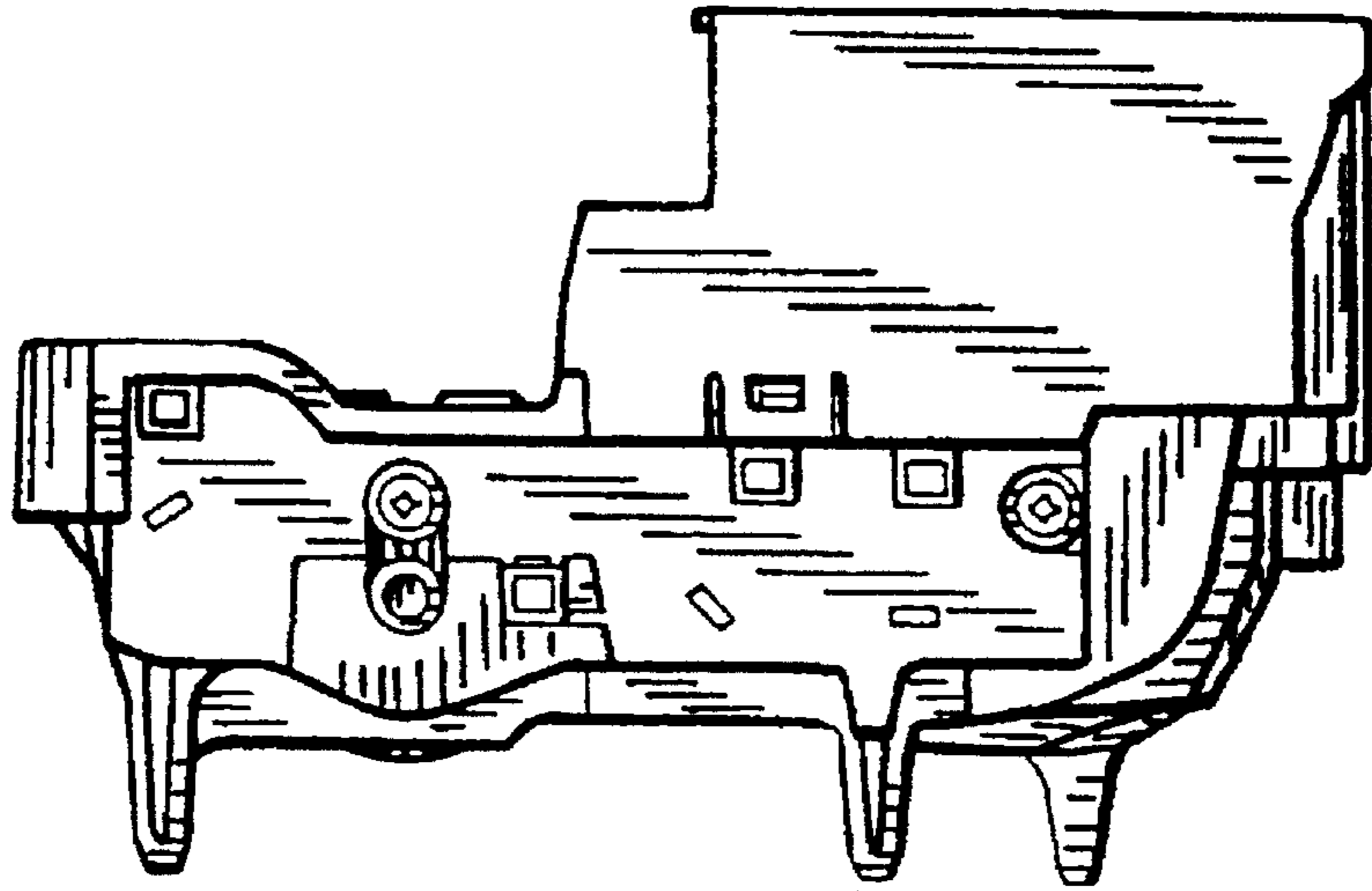

FIG. 6

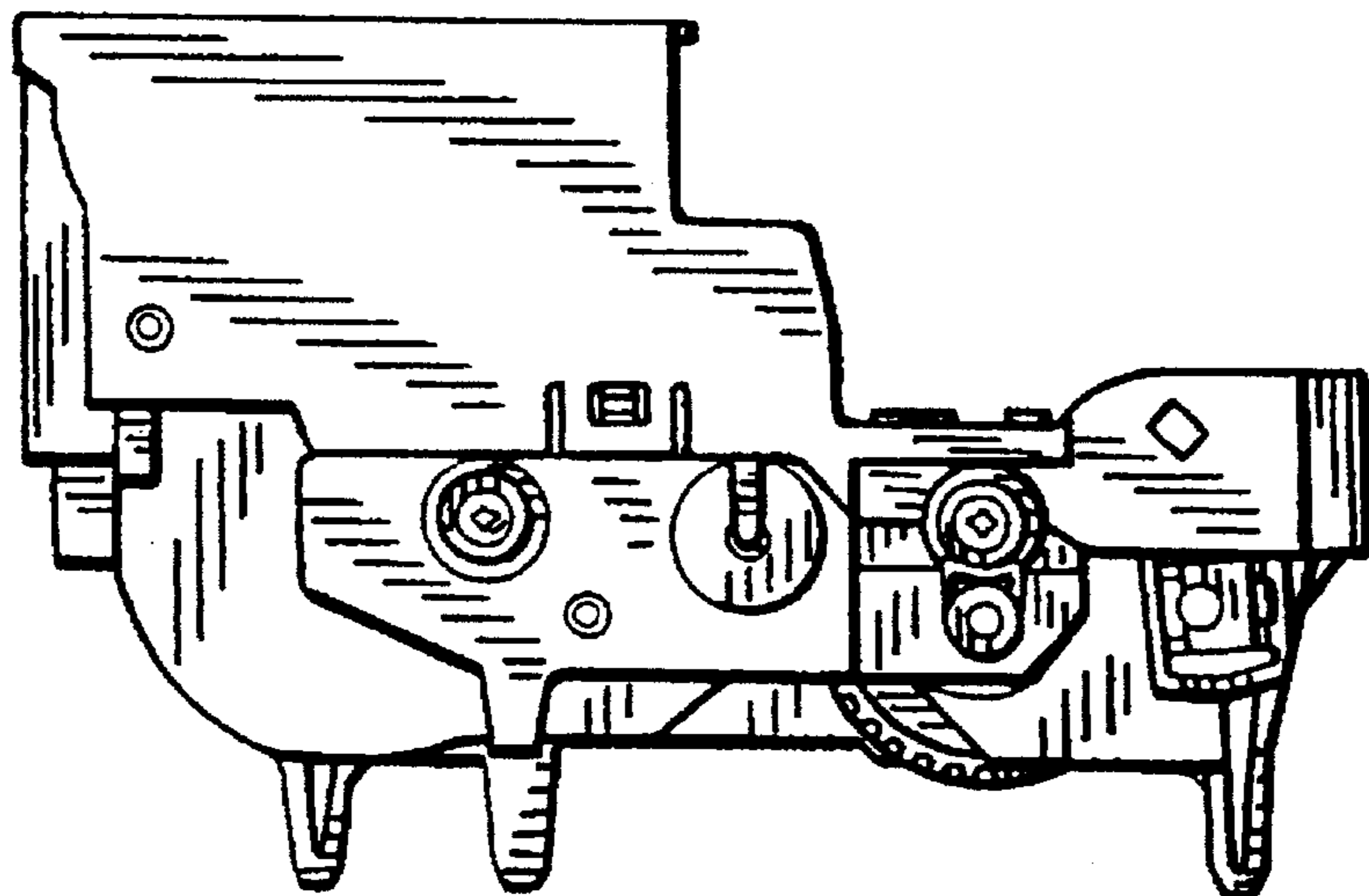

FIG. 7

