



US00D374224S

**United States Patent** [19]  
**Starck**

[11] **Patent Number:** **Des. 374,224**

[45] **Date of Patent:** **\*\*Oct. 1, 1996**

[54] **TELEVISION SET**

[75] Inventor: **Philippe Starck**, Issy-les-Moulineaux,  
France

[73] Assignee: **Thomson Consumer Electronics**  
**(Societe Anonyme)**, Courbevoie, France

[\*\*] Term: **14 Years**

[21] Appl. No.: **41,826**

[22] Filed: **Jul. 25, 1995**

[30] **Foreign Application Priority Data**

Jan. 26, 1995 [FR] France ..... 95 0478

[52] U.S. Cl. .... **D14/126**

[58] Field of Search ..... D14/113, 124-134;  
312/7.2; 348/825, 386, 838

[56] **References Cited**

**U.S. PATENT DOCUMENTS**

D. 308,365 6/1990 Takechi ..... D14/126

*Primary Examiner*—Terry A. Wallace

*Assistant Examiner*—Richelle Shelton  
*Attorney, Agent, or Firm*—McAulay Fisher Nissen Goldberg  
& Kiel, LLP

[57] **CLAIM**

The ornamental design for a television set, as shown and described.

**DESCRIPTION**

FIG. 1 is a front view of a television set showing my new design;

FIG. 2 is a right side view thereof;

FIG. 3 is a left side view thereof;

FIG. 4 is a rear view thereof;

FIG. 5 is a top view thereof;

FIG. 6 is a bottom view thereof;

FIG. 7 is a front view of a second embodiment of the television set;

FIG. 8 is a right side view thereof;

FIG. 9 is a left side view thereof;

FIG. 10 is a rear view thereof;

FIG. 11 is a top view thereof; and,

FIG. 12 is a bottom view thereof.

**1 Claim, 6 Drawing Sheets**

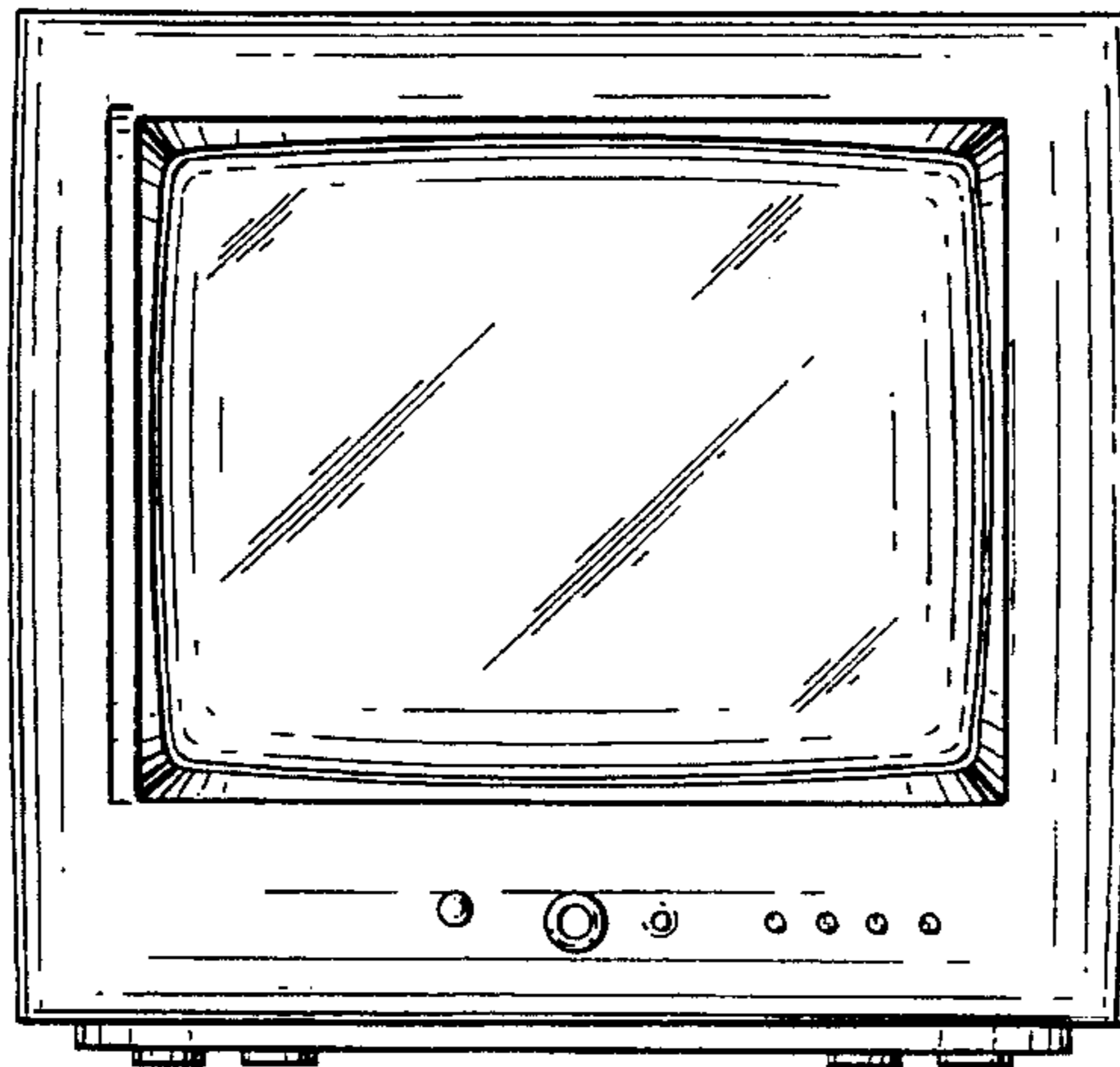
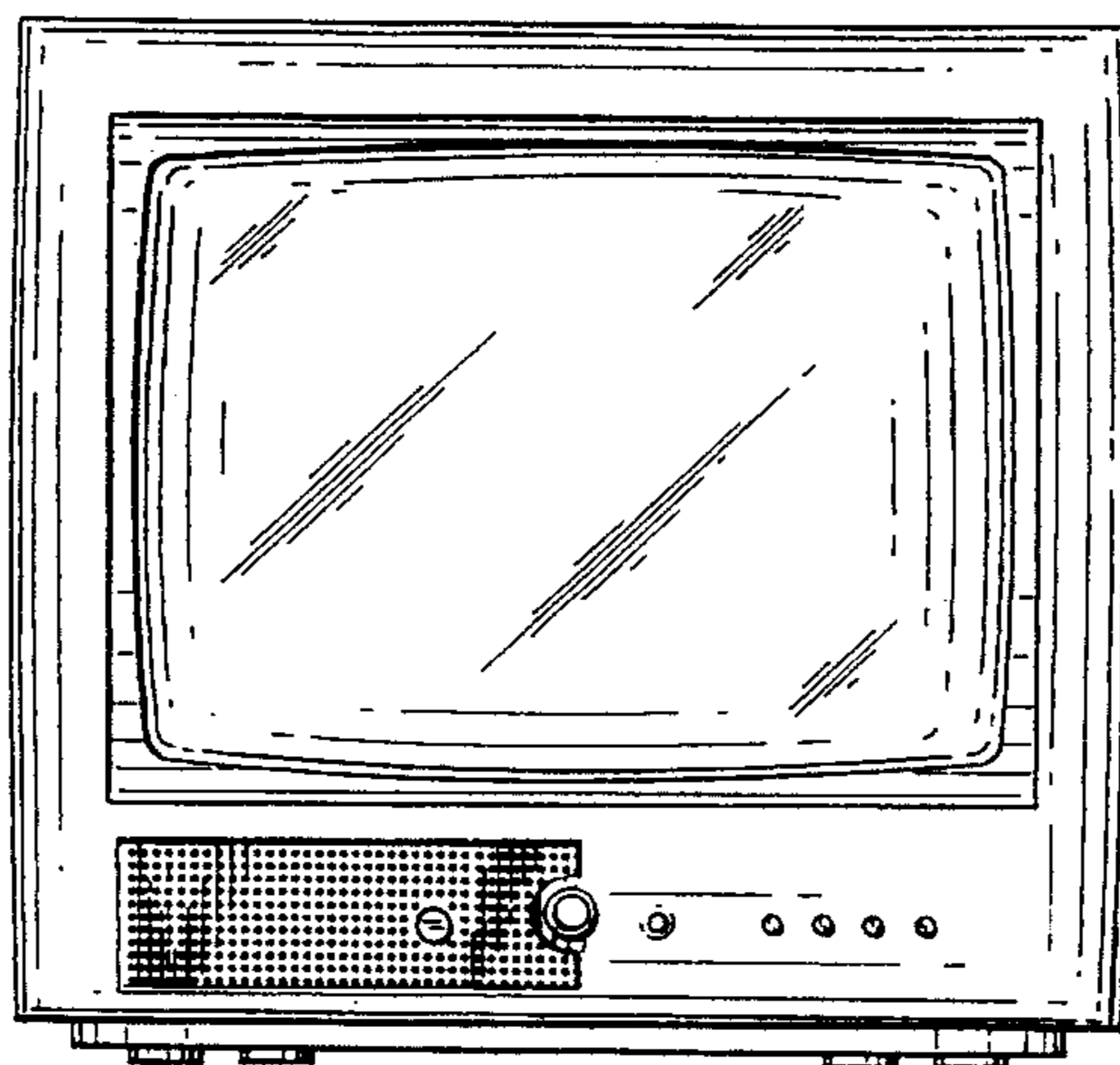

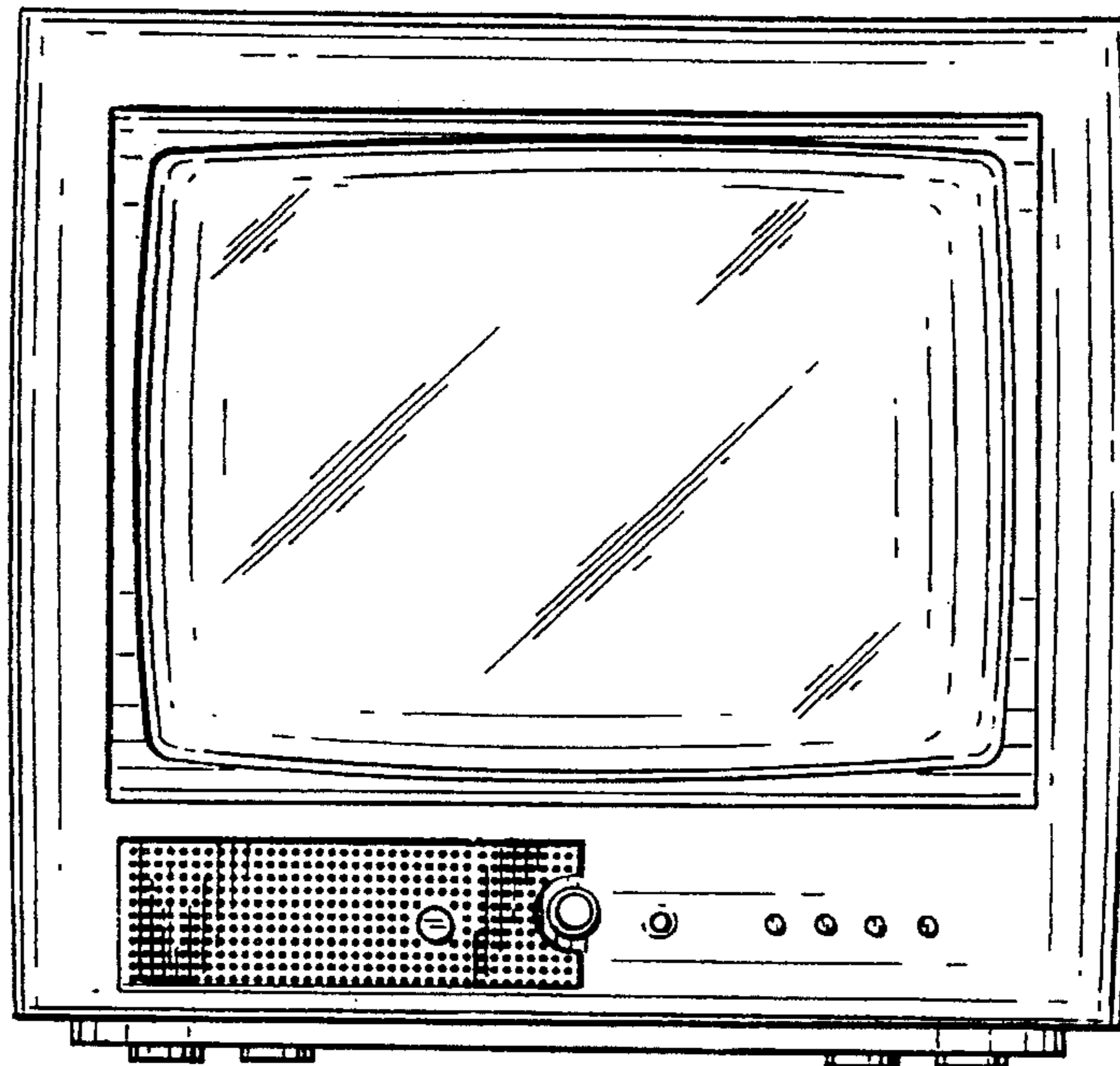

FIG. 1

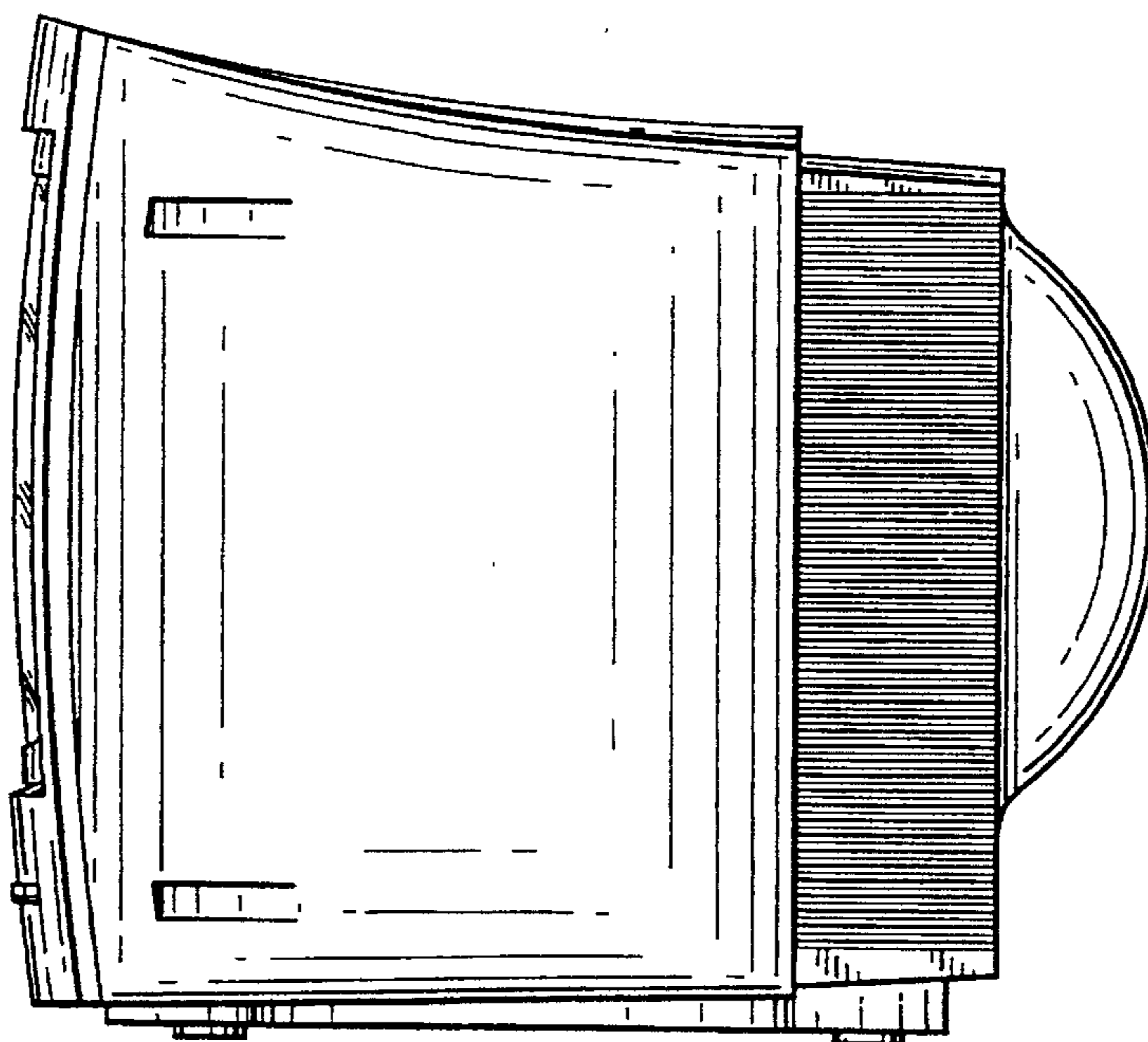

FIG. 2

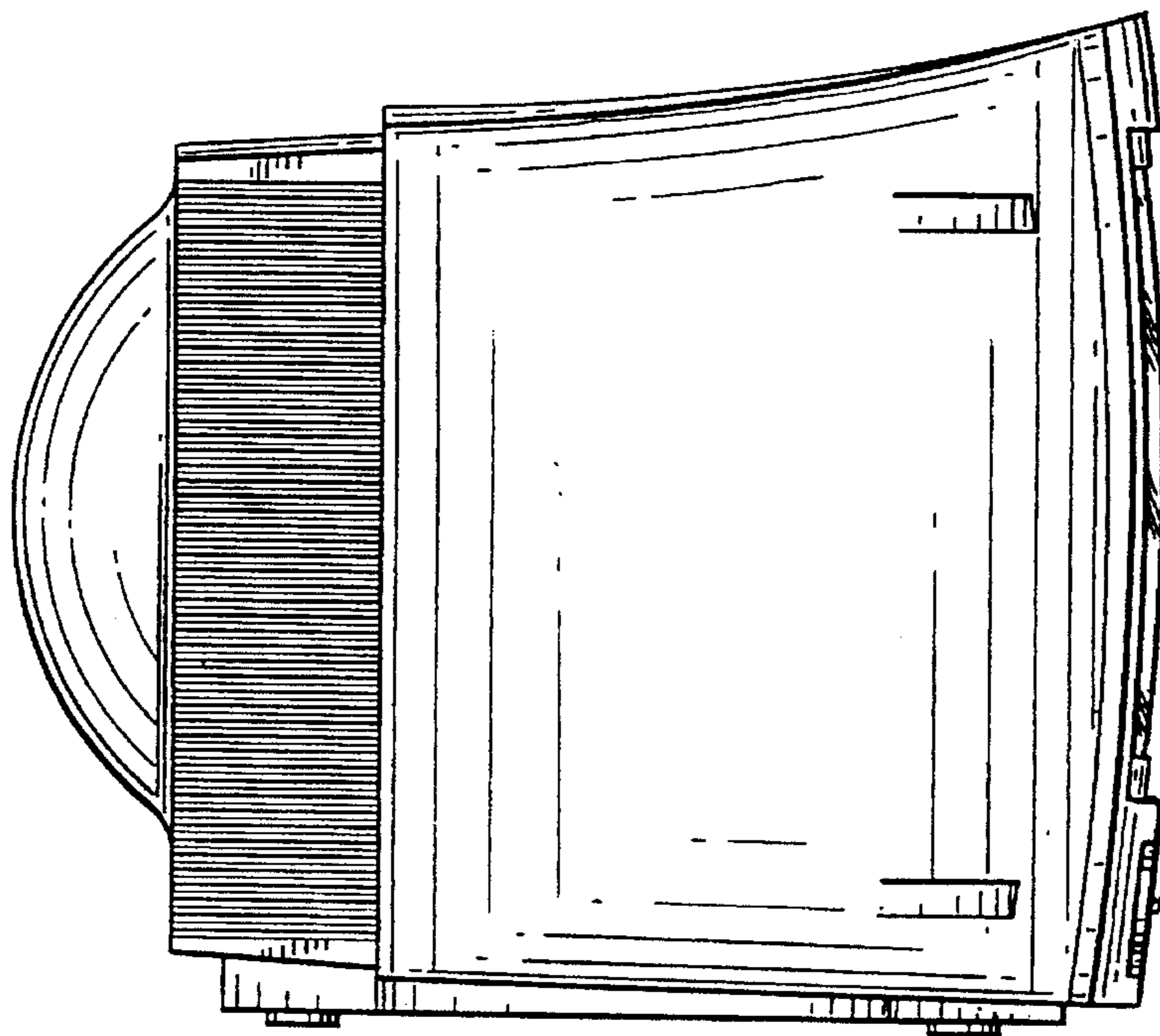

FIG.3

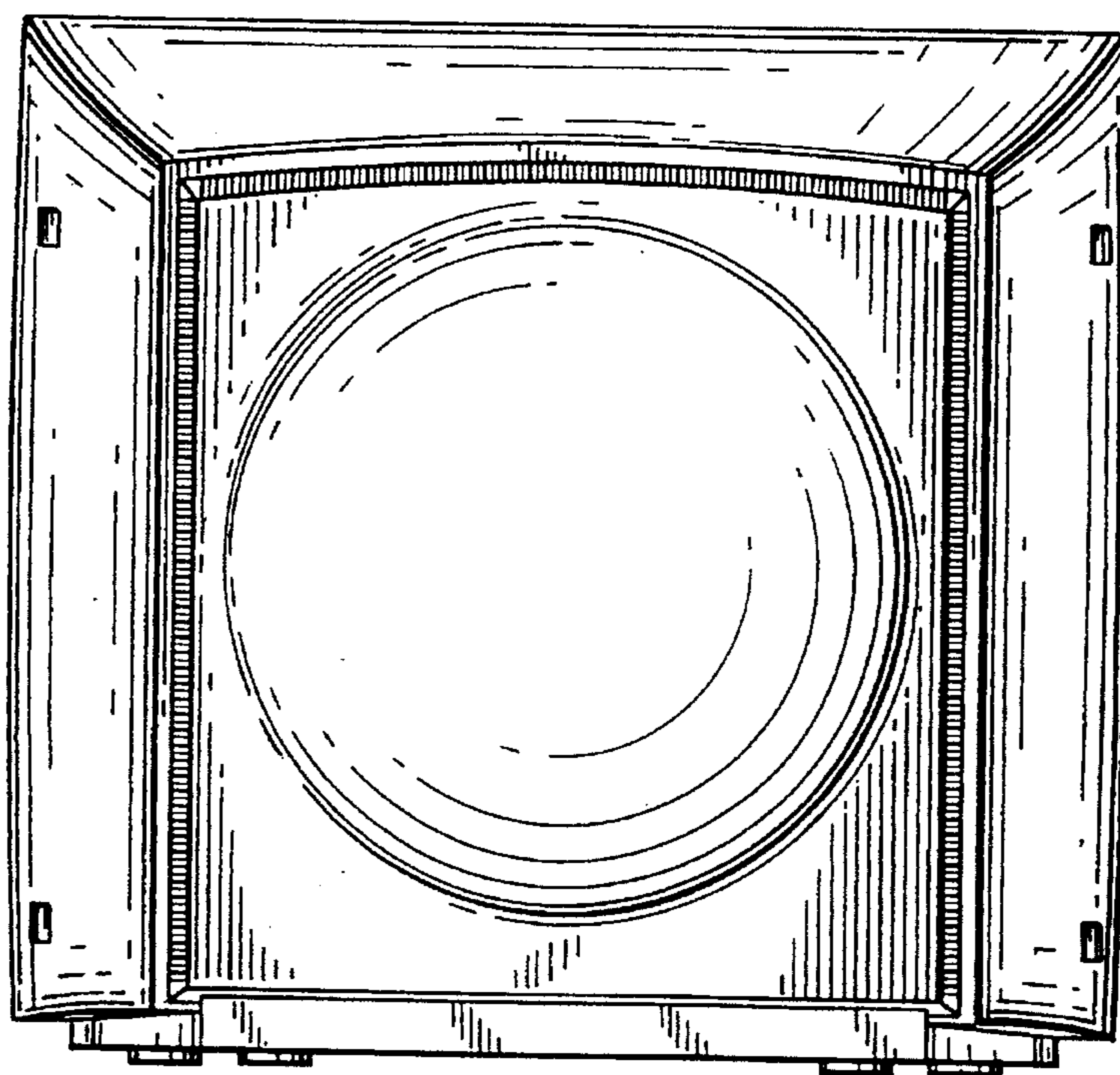

FIG.4

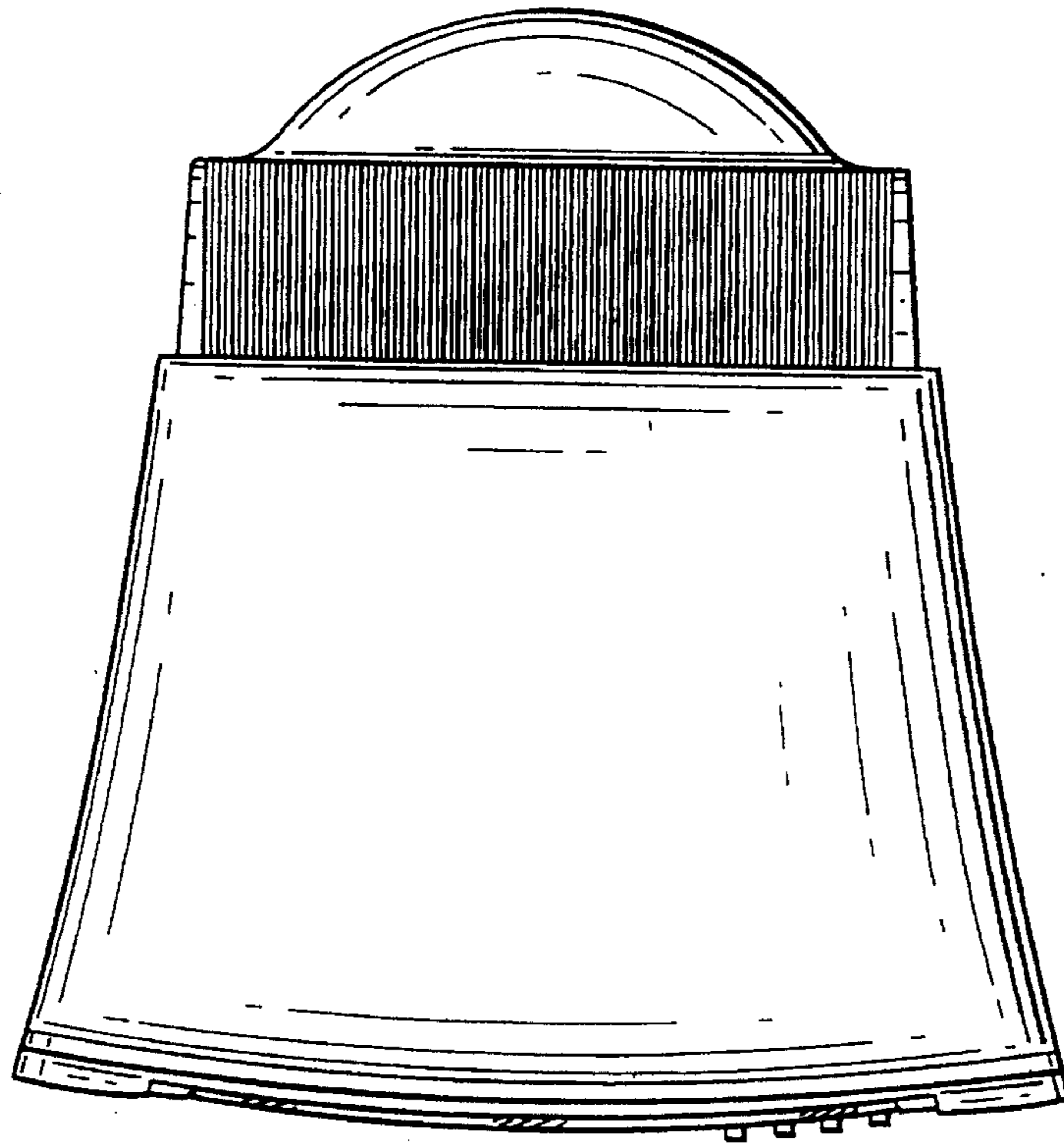

FIG. 5

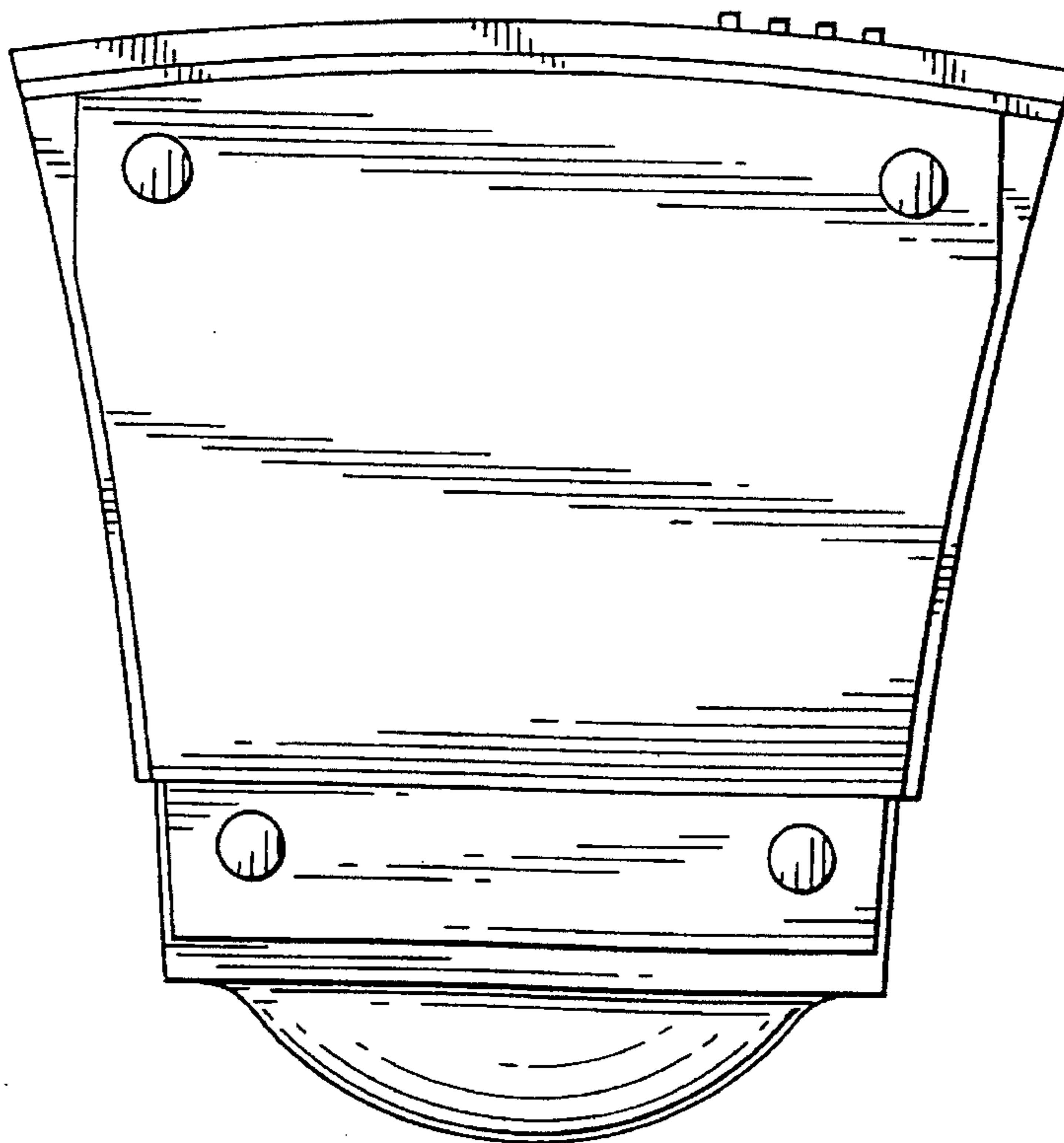

FIG. 6

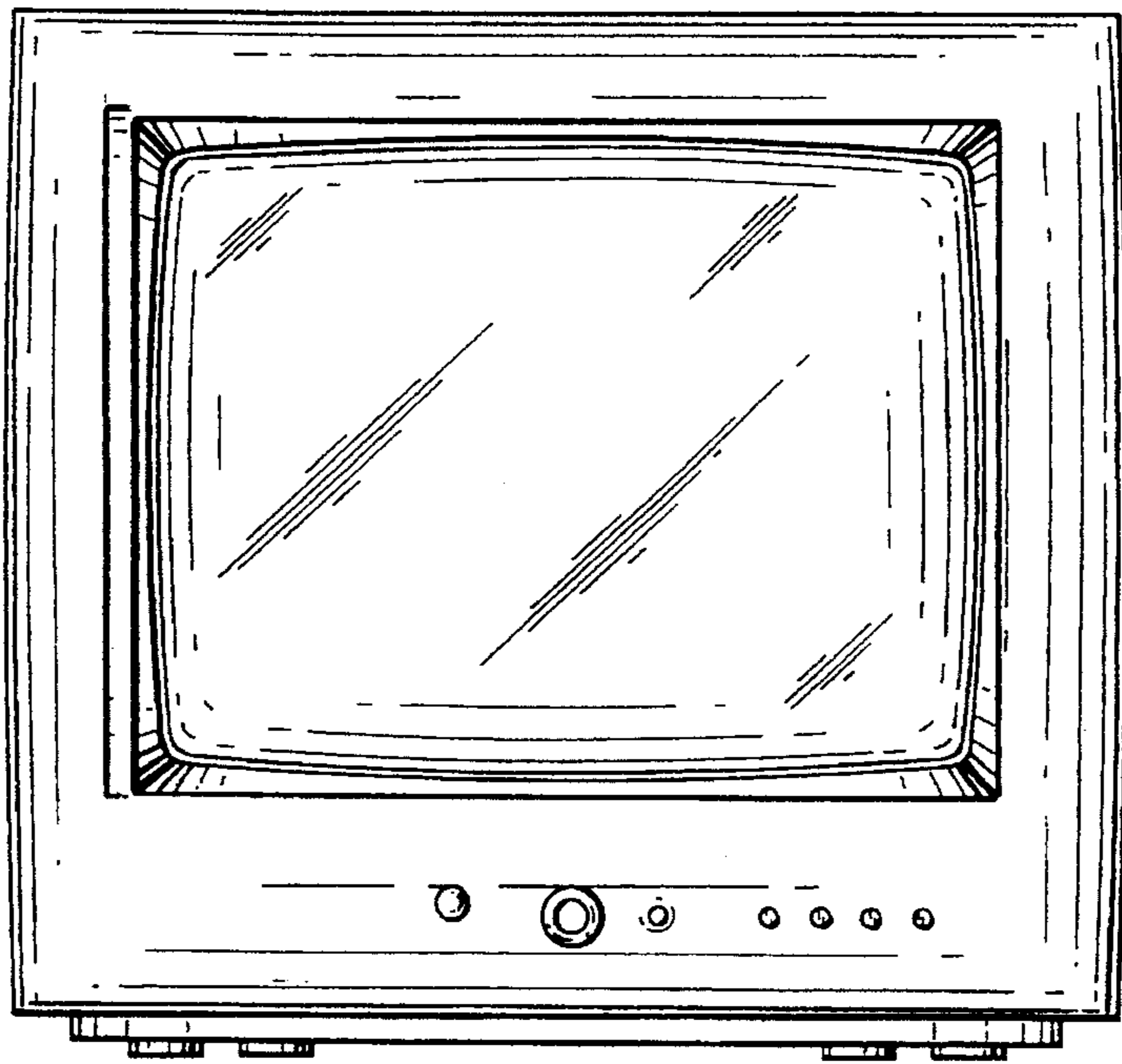

FIG. 7

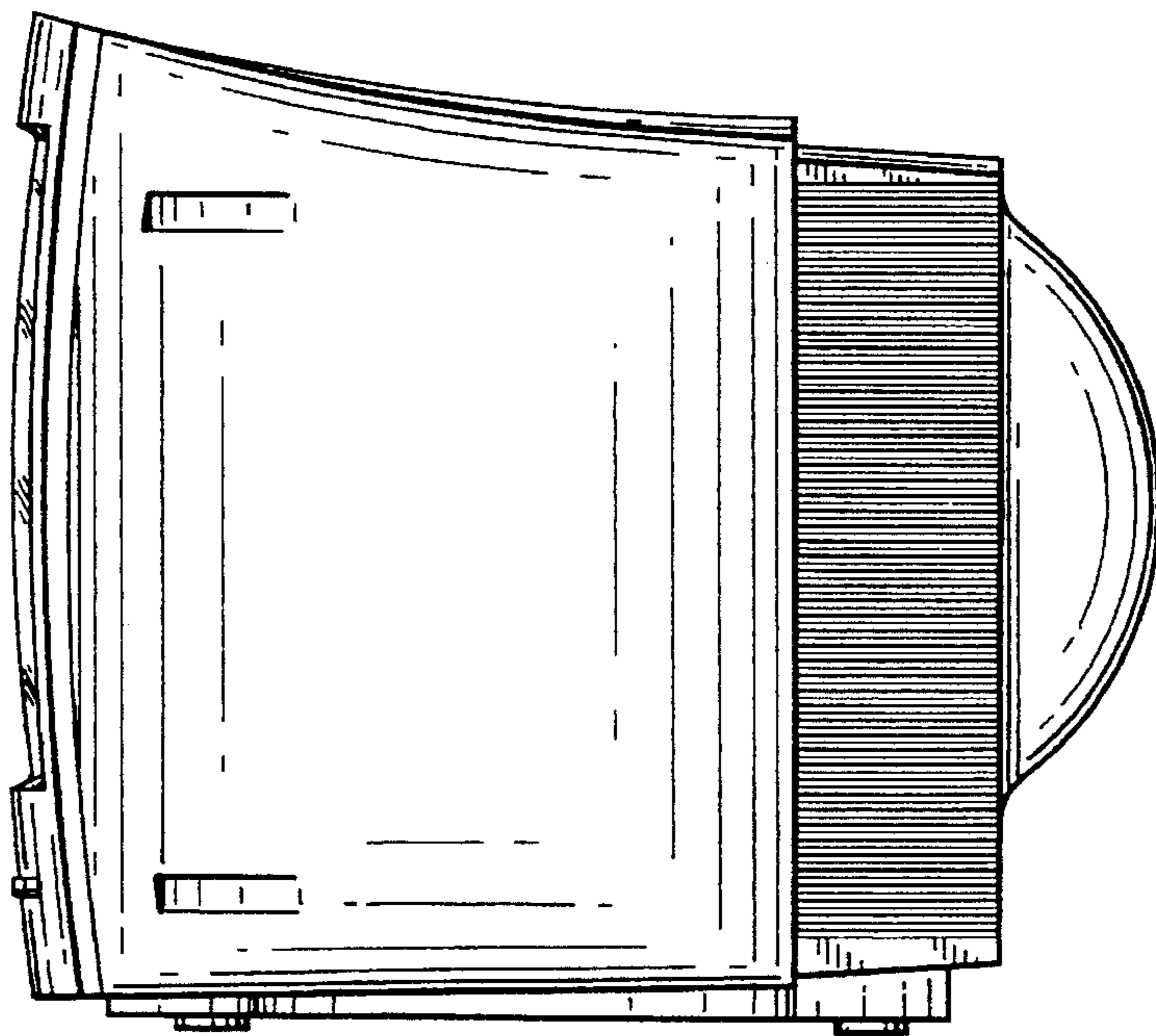

FIG. 8

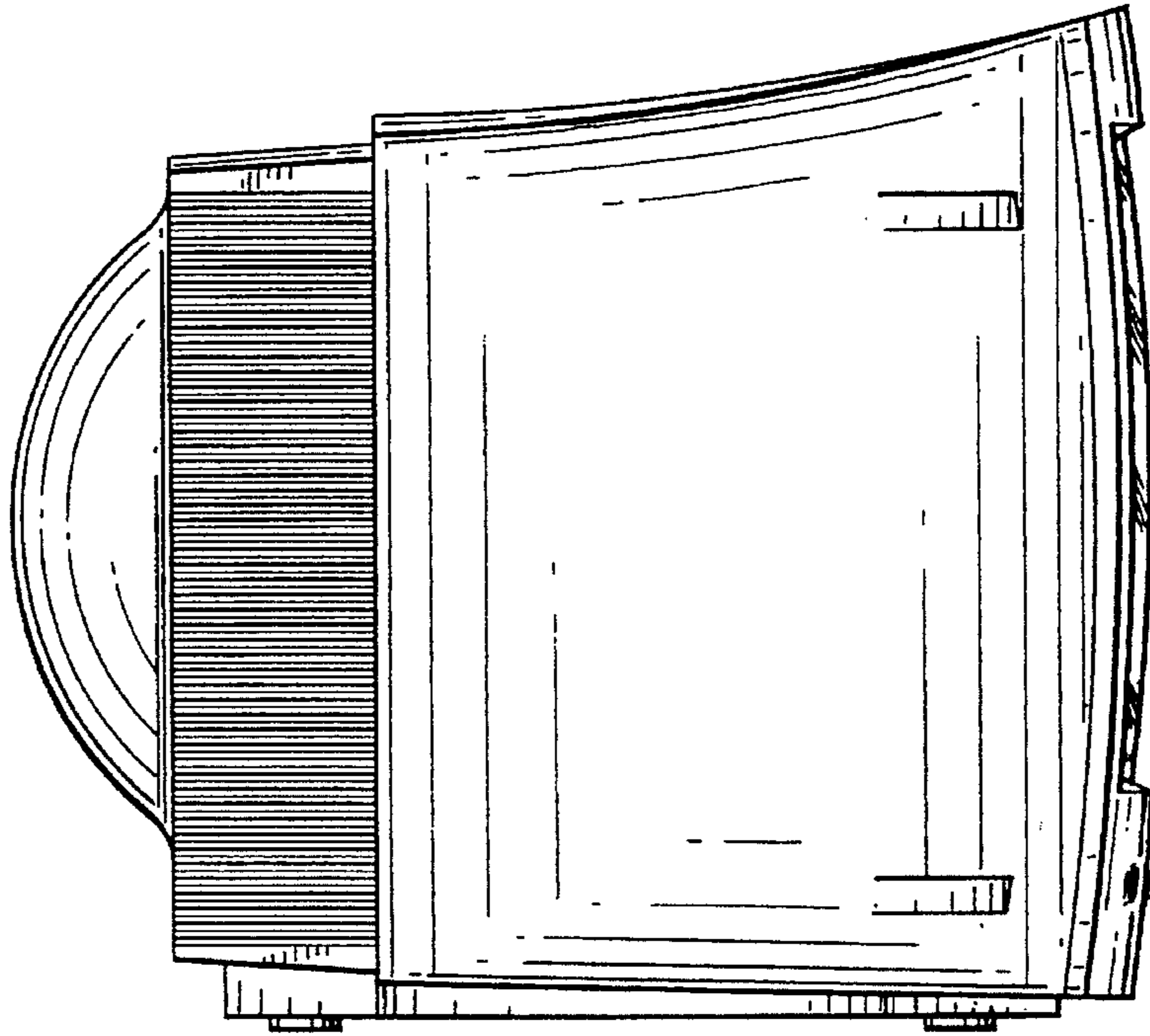

FIG. 9

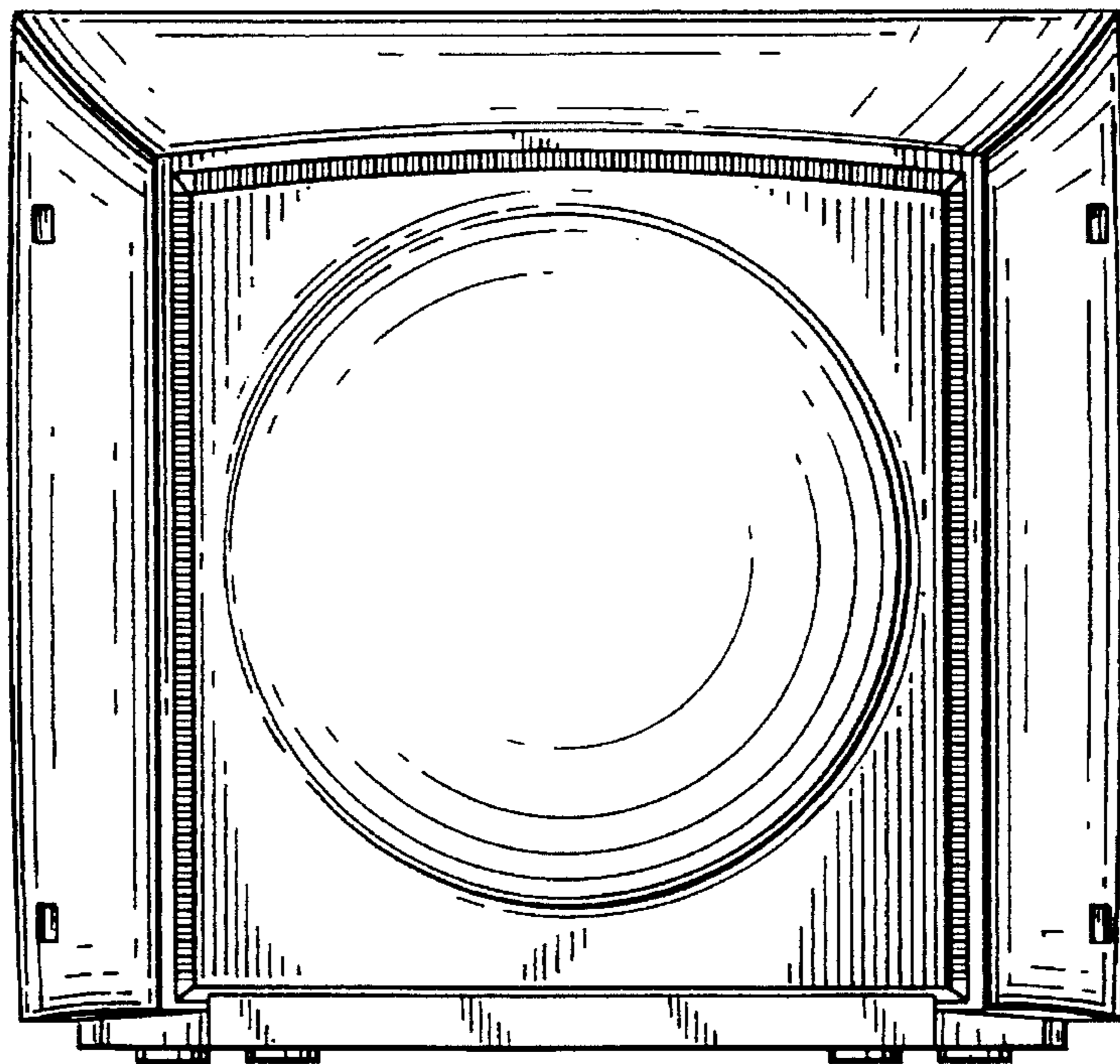

FIG. 10

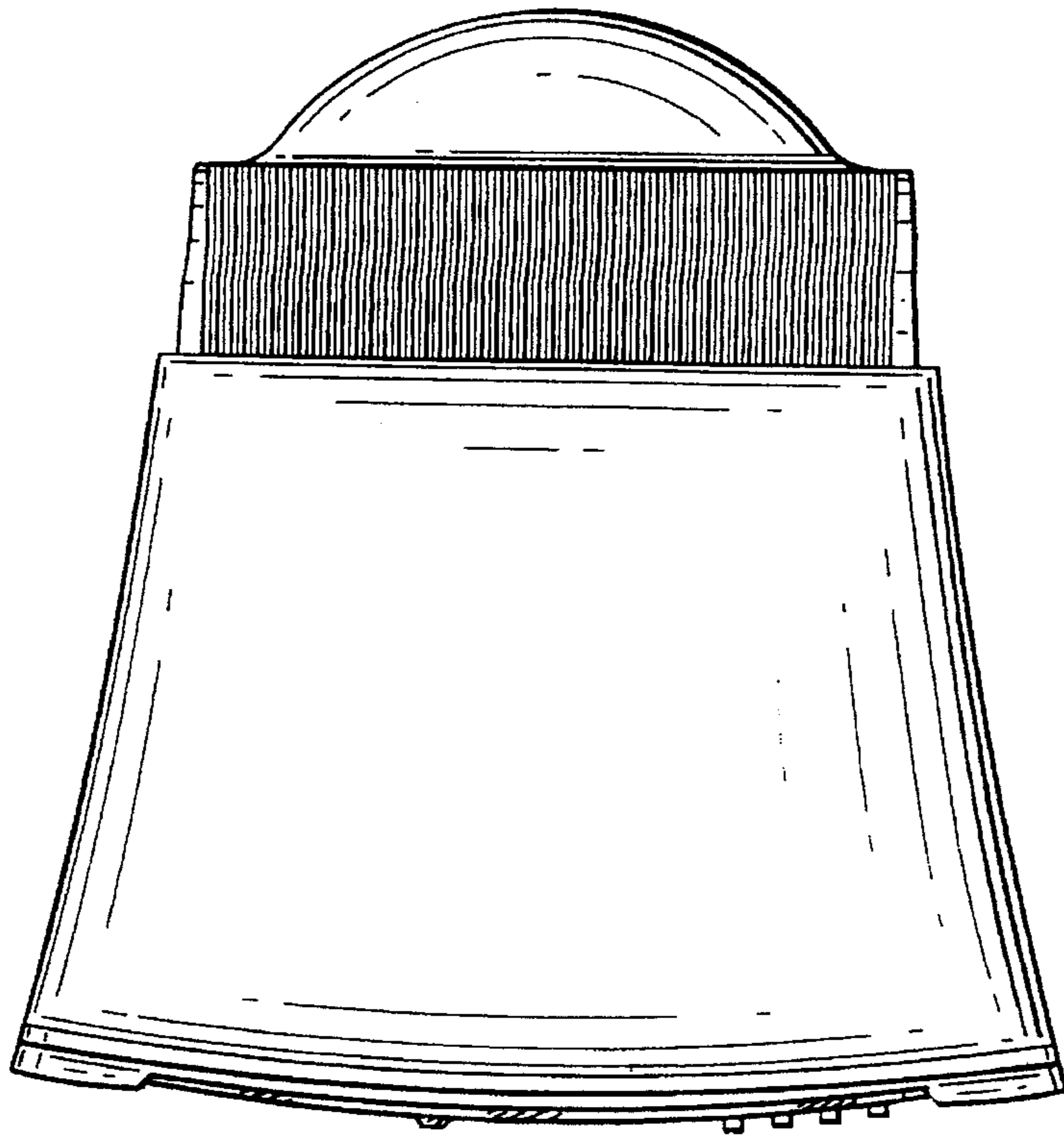

FIG. 11

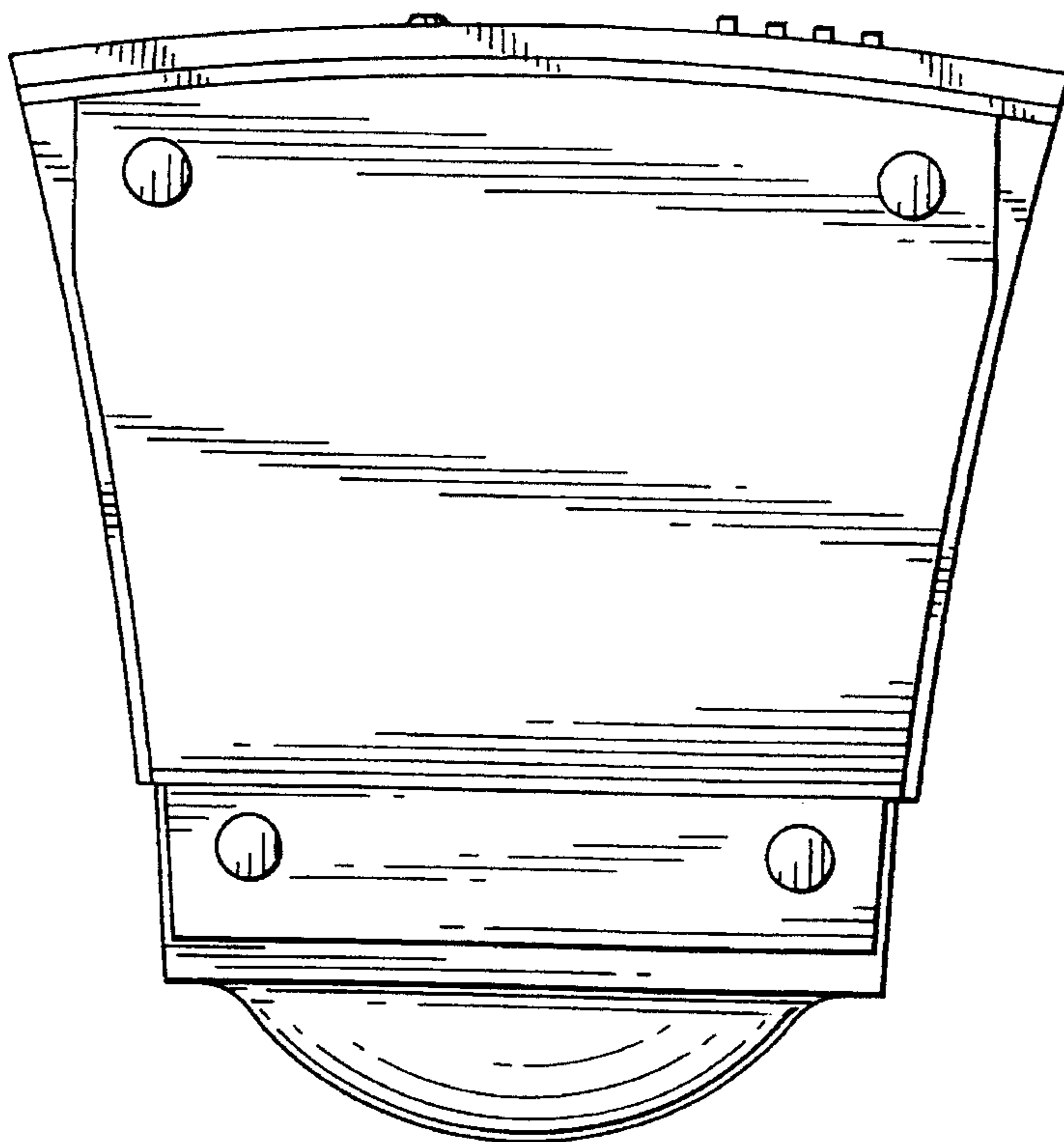

FIG. 12