



US00D374173S

United States Patent [19]

[11] Patent Number: **Des. 374,173**

Linner

[45] Date of Patent: ****Oct. 1, 1996**

[54] TUBE

[75] Inventor: **Hans Linner**, Kalmar, Sweden

[73] Assignee: **Norden Pac Development AB**, Sweden

[**] Term: **14 Years**

[21] Appl. No.: **12,177**

[22] Filed: **Aug. 25, 1993**

[30] Foreign Application Priority Data

Feb. 26, 1993 [SE] Sweden 93-0499

[52] U.S. Cl. **D9/302**

[58] Field of Search D9/302; 222/92,
222/94, 106, 107

[56] References Cited

U.S. PATENT DOCUMENTS

- D. 22,873 11/1893 Calcutt .
- D. 99,430 4/1936 Chase .
- D. 342,442 12/1993 Smith D9/302
- D. 344,888 3/1994 Linner .
- D. 349,449 8/1994 Linner .
- D. 349,856 8/1994 Linner .
- D. 351,101 10/1994 Linner .
- D. 353,539 12/1994 Linner .
- D. 358,760 5/1995 Sherman et al. .
- 3,166,221 1/1965 Nielsen .
- 3,581,940 6/1971 Cella .
- 3,729,553 4/1973 Gold et al. .
- 3,782,600 1/1974 Columbus 222/94
- 3,866,800 2/1975 Schmitt .
- 4,687,663 8/1987 Schaeffer .
- 4,723,671 2/1988 Mears .
- 4,964,539 10/1990 Mueller .
- 4,974,756 12/1990 Pearson et al. 222/94 X
- 5,038,963 8/1991 Pettengill et al. .
- 5,114,044 5/1992 Spanek, Jr. 222/94
- 5,137,178 8/1992 Stokes et al. .
- 5,143,261 9/1992 Drobish .
- 5,269,441 12/1993 O'Meara 222/94
- 5,316,184 5/1994 Düring 222/107
- 5,318,203 6/1994 Iaia et al. 222/94

FOREIGN PATENT DOCUMENTS

2647093 5/1989 France .

- 819617 9/1951 Germany .
- 3616207 11/1987 Germany .
- 3162248 7/1991 Japan .
- 1103534 3/1968 United Kingdom .
- 9105731 5/1991 WIPO .
- 9419251 9/1994 WIPO .

OTHER PUBLICATIONS

Avon; Campaign 8, 1983; p. 70; "Active Aid" Tube upper left corner of page.

Drug and Cosmetic Industry; Jan. 1989; p. 56; "Vidal Sassoon" Tubes.

BF Beauty Fashion; Mar. 1989; p. 57.

Primary Examiner—Ted Shooman

Assistant Examiner—Cheri Cohen

Attorney, Agent, or Firm—Lerner, David, Littenberg, Krumholz & Mentlik

[57] CLAIM

The ornamental design for a tube, as shown and described.

DESCRIPTION

FIG. 1 is a front perspective view of a tube showing my new design;

FIG. 2 is a rear perspective view thereof;

FIG. 3 is a front elevational view thereof;

FIG. 4 is a front perspective view, shown in sealed condition;

FIG. 5 is a rear perspective view of FIG. 4;

FIG. 6 is a front elevational view of FIG. 4;

FIG. 7 is a front perspective view of a second embodiment of the tube as disclosed in FIG. 1;

FIG. 8 is a rear perspective view of FIG. 7;

FIG. 9 is a front elevational view of FIG. 7;

FIG. 10 is a front perspective view, shown in sealed condition;

FIG. 11 is a rear perspective view of FIG. 10;

FIG. 12 is a front elevational view of FIG. 10;

FIG. 13 is a front perspective view of a third embodiment of the tube as disclosed in FIG. 1;

FIG. 14 is a rear perspective view of FIG. 13;

FIG. 15 is a front elevational view of FIG. 13;

FIG. 16 is a front perspective view, shown in sealed condition;

FIG. 17 is a rear perspective view of FIG. 16;

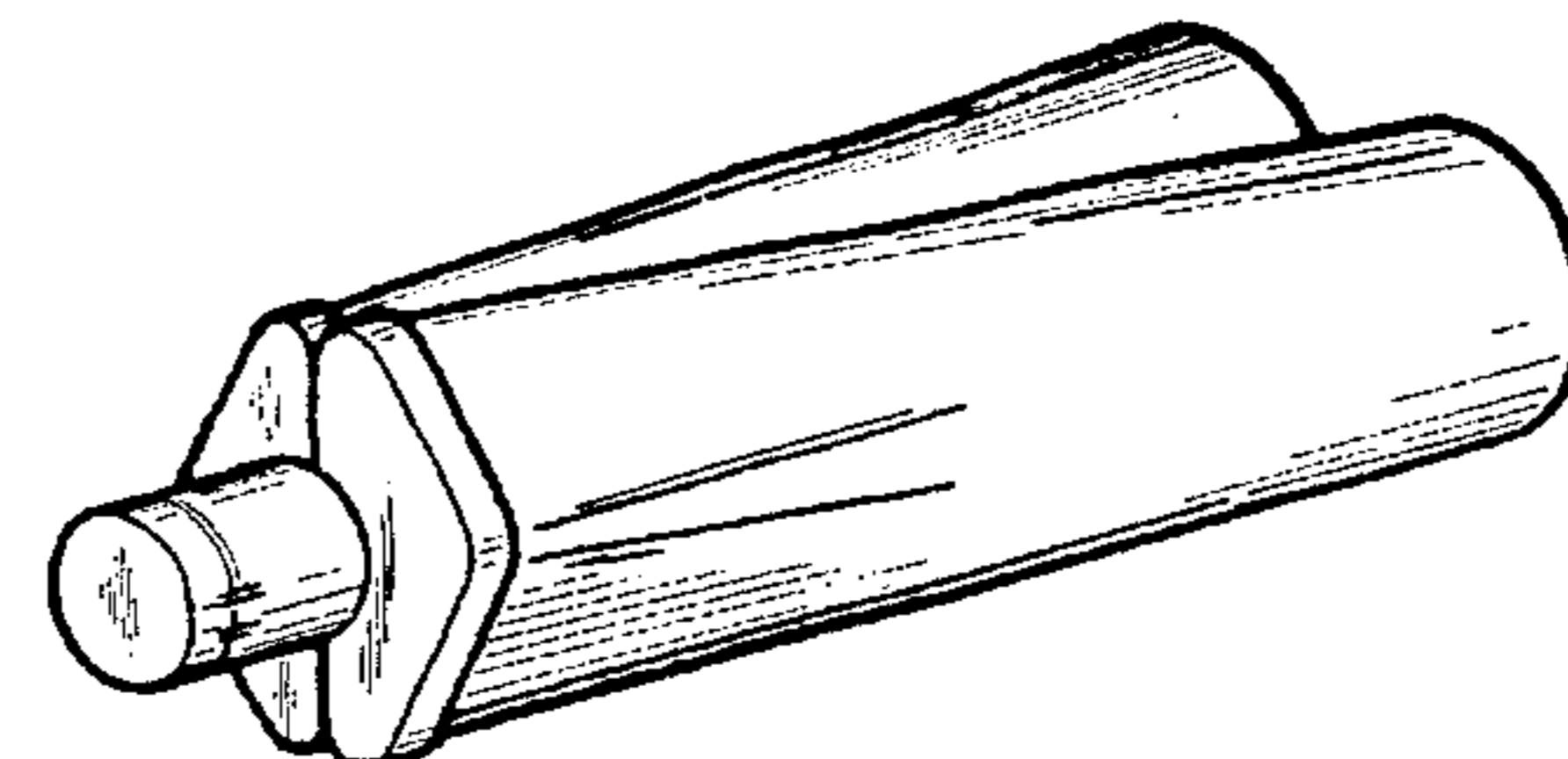
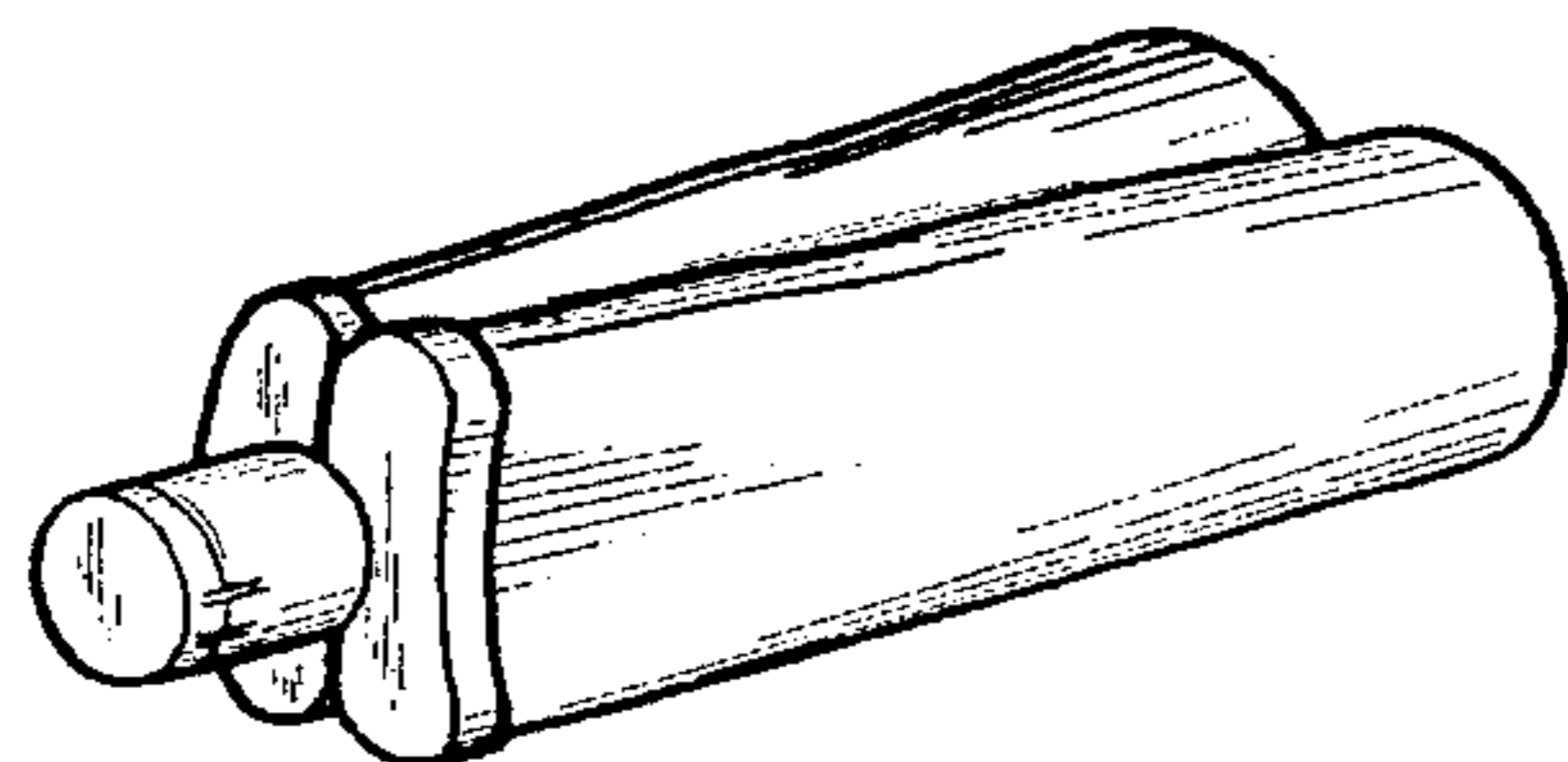
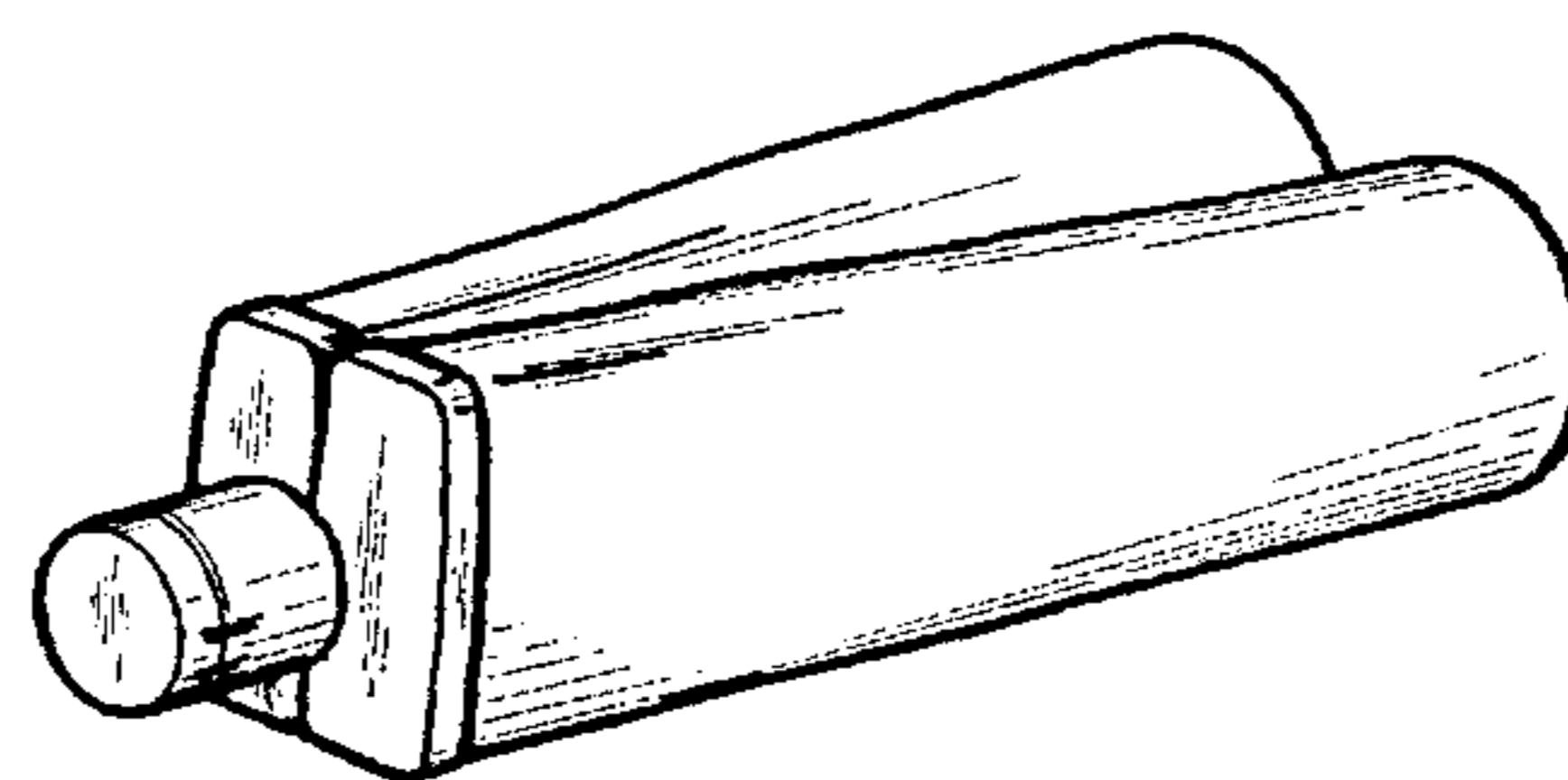
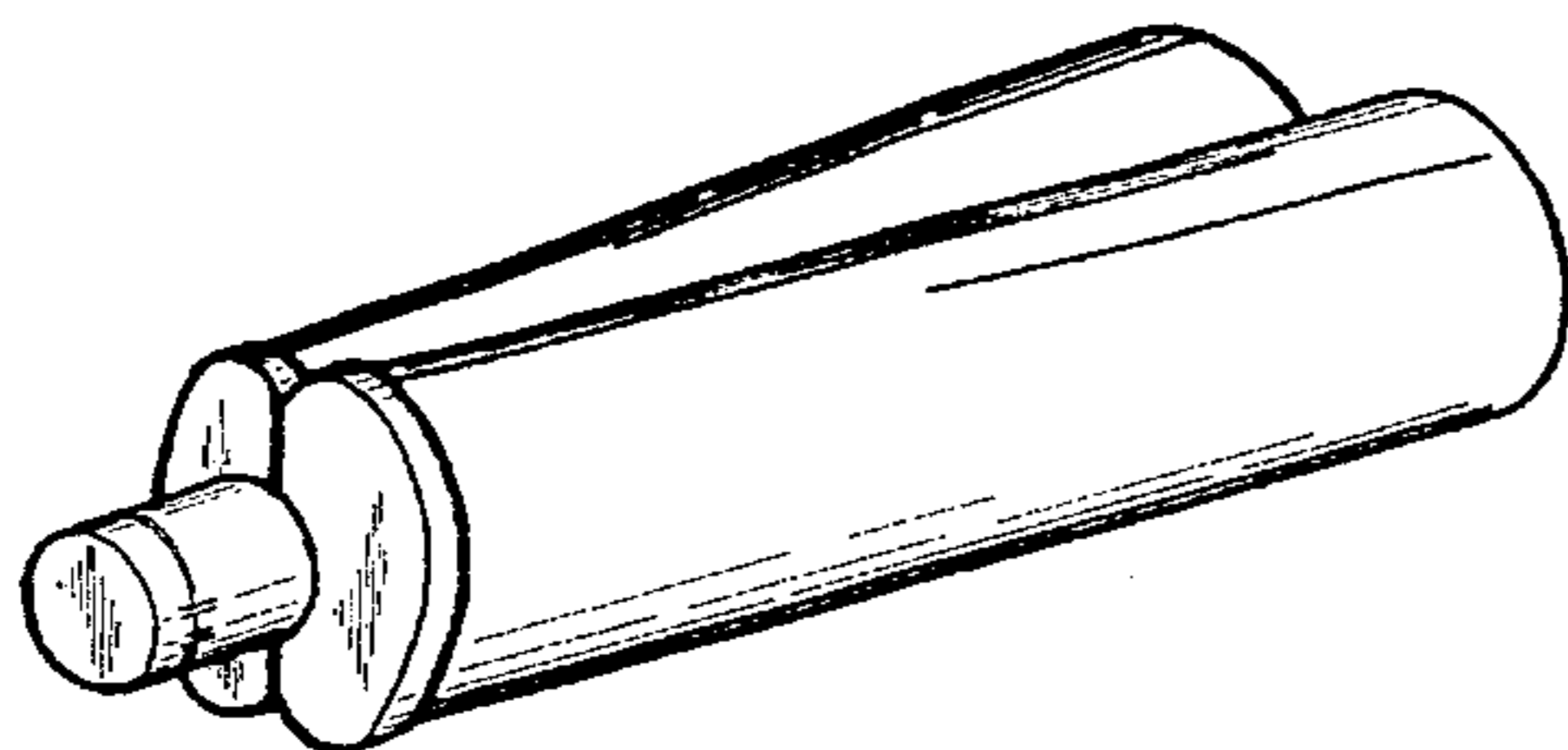

FIG. 18 is a front elevational view of FIG. 16;
FIG. 19 is a front perspective view of a fourth embodiment of the tube as disclosed in FIG. 1;
FIG. 20 is a rear perspective view of FIG. 19;
FIG. 21 is a front elevational view of FIG. 19;
FIG. 22 is a front perspective view, shown in sealed condition;

FIG. 23 is a rear perspective view of FIG. 22; and,
FIG. 24 is a front elevational view of FIG. 22.

1 Claim, 4 Drawing Sheets

FIG. 1

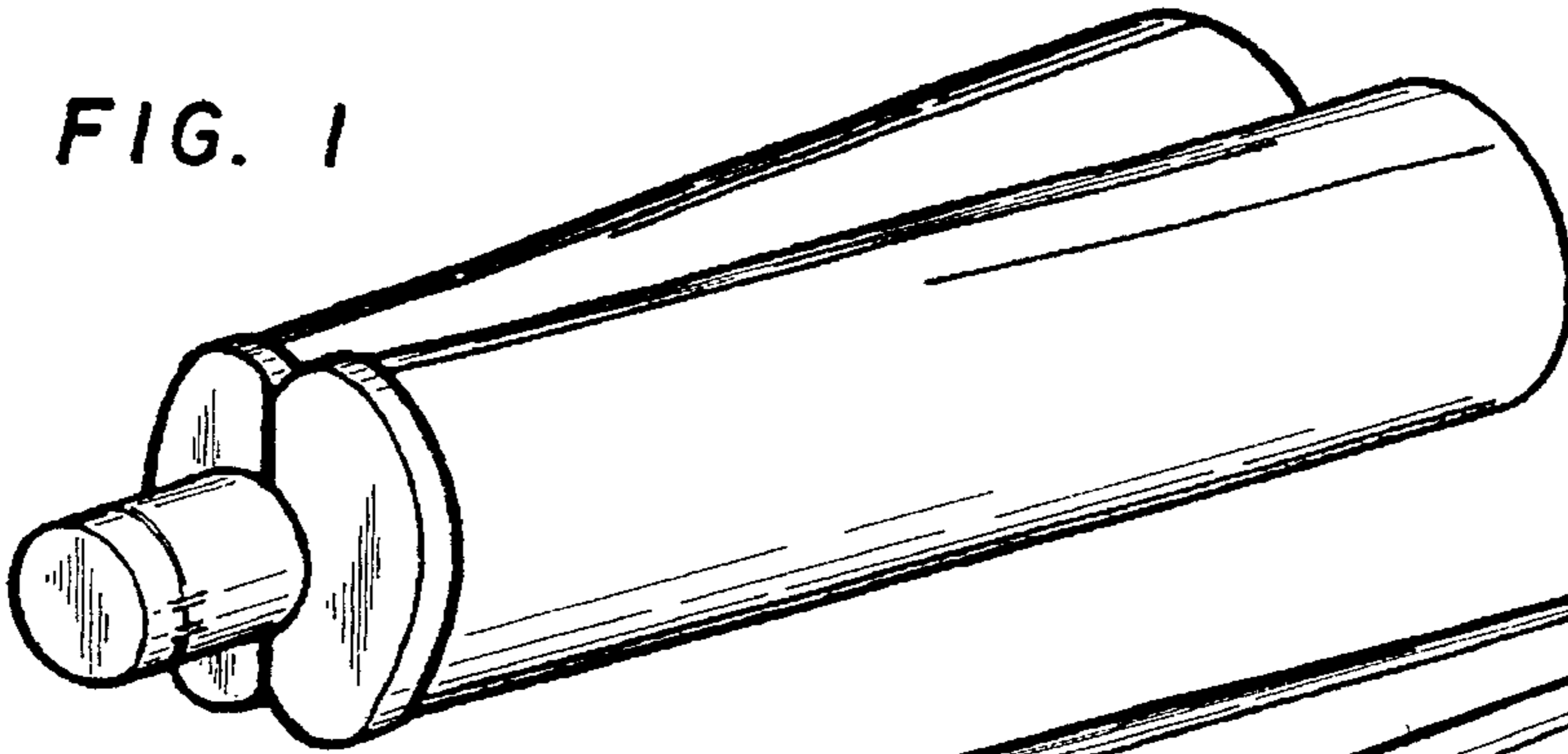

FIG. 2

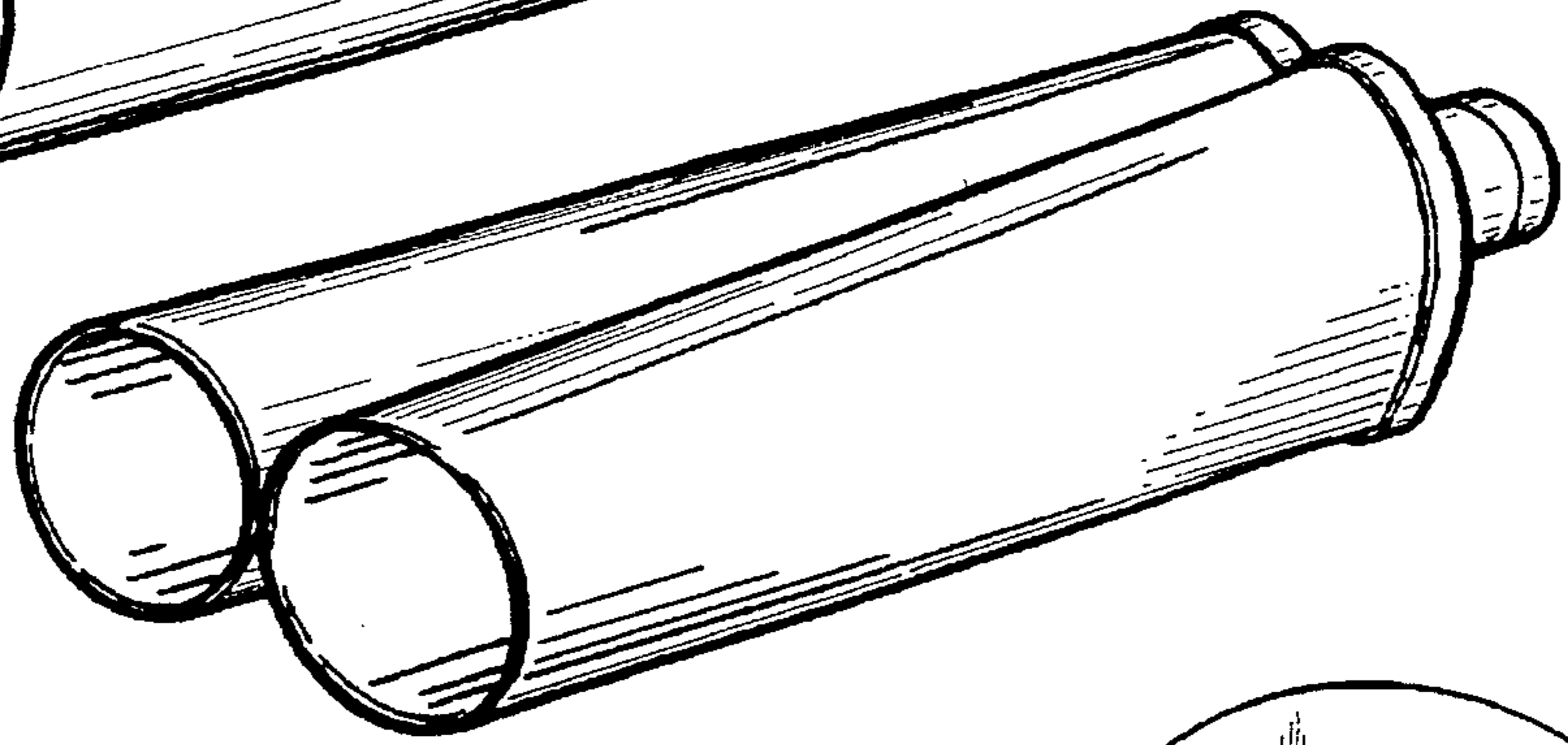

FIG. 4

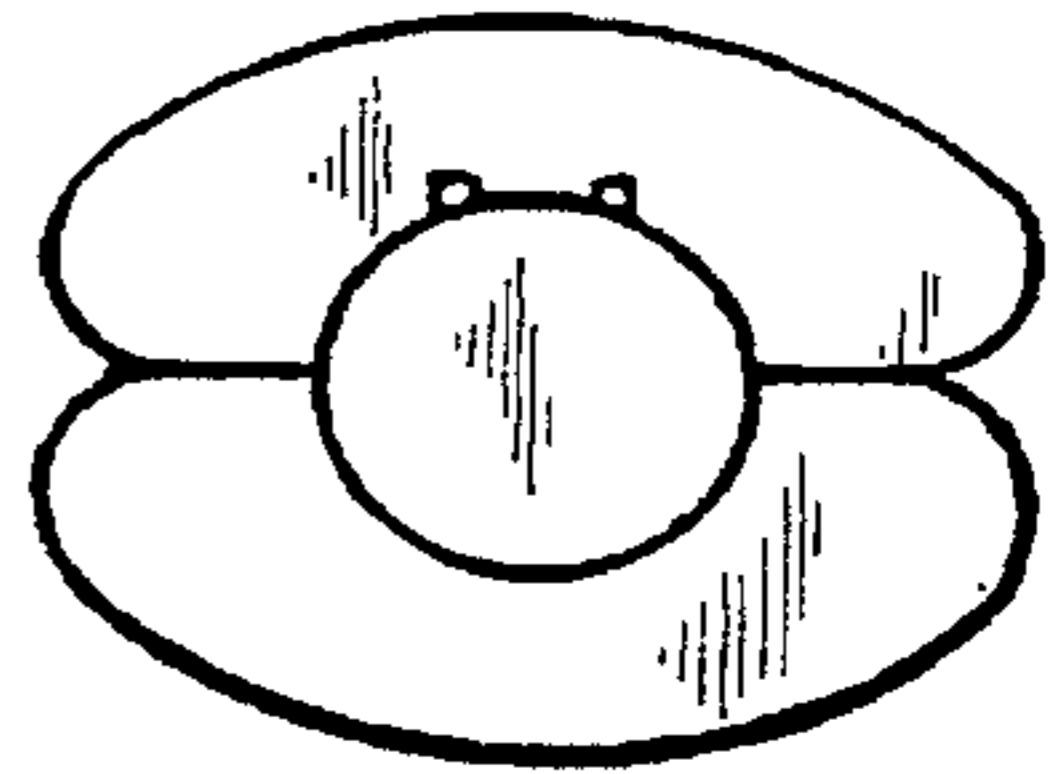
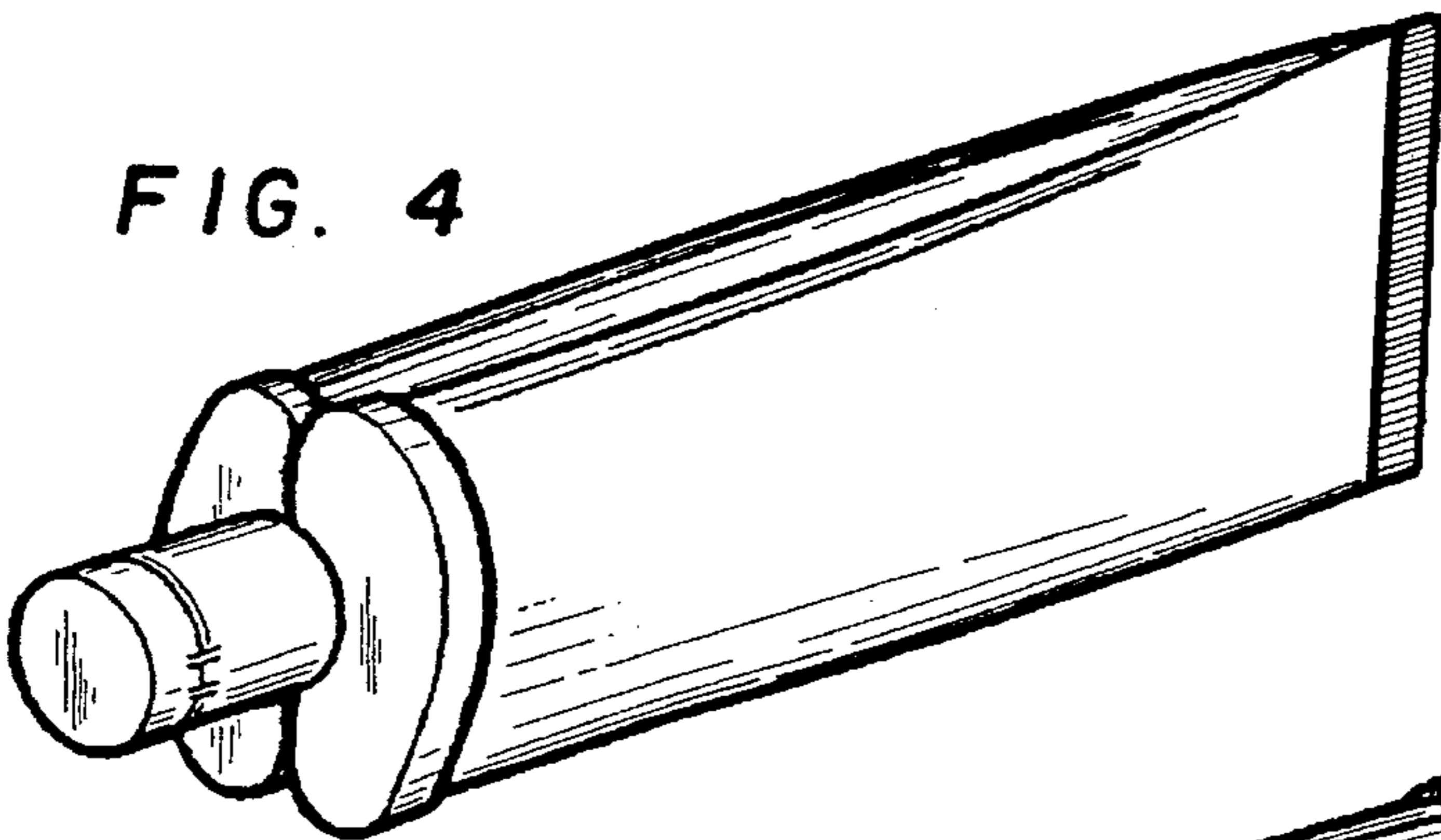

FIG. 3

FIG. 5

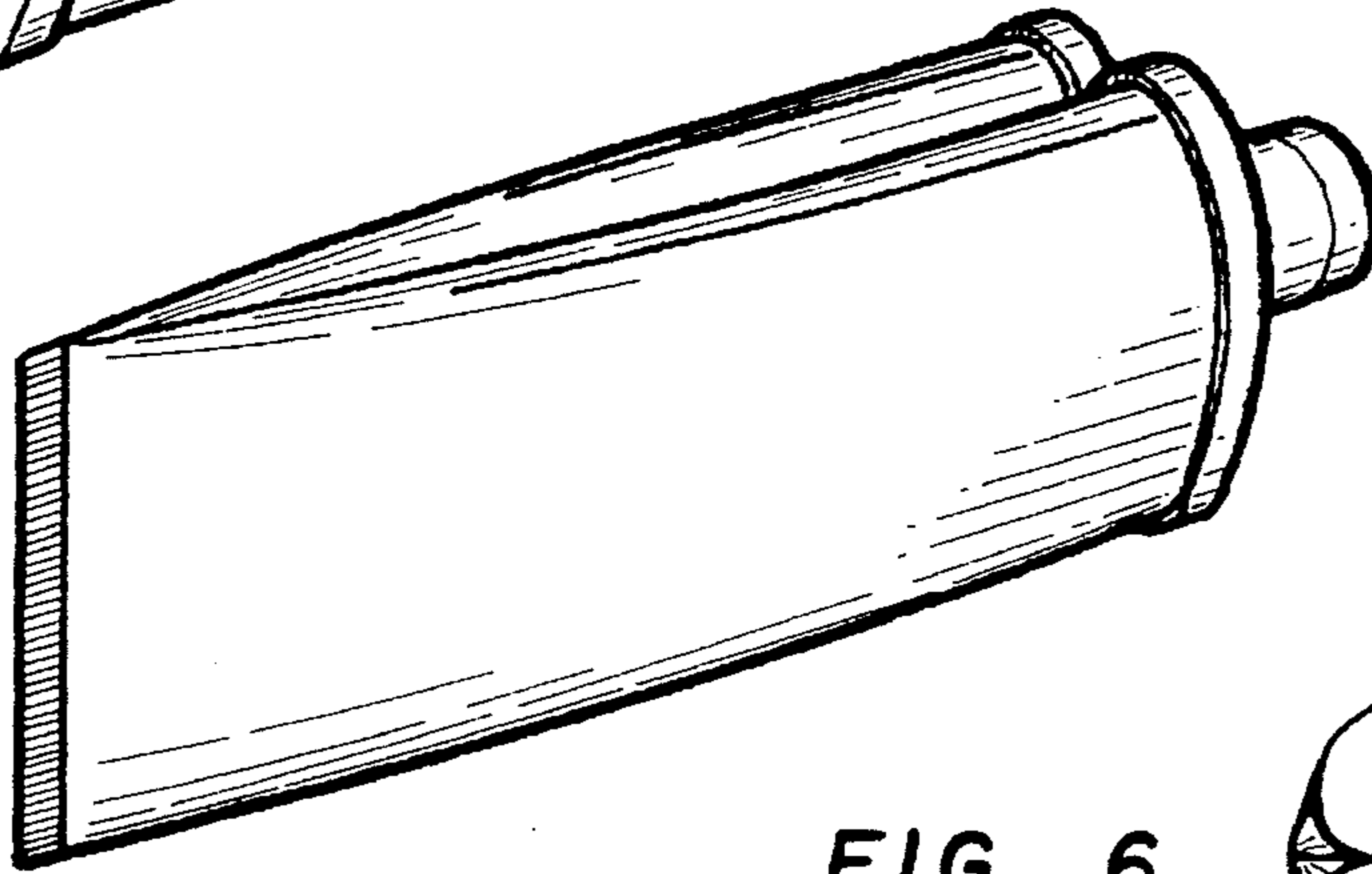

FIG. 6

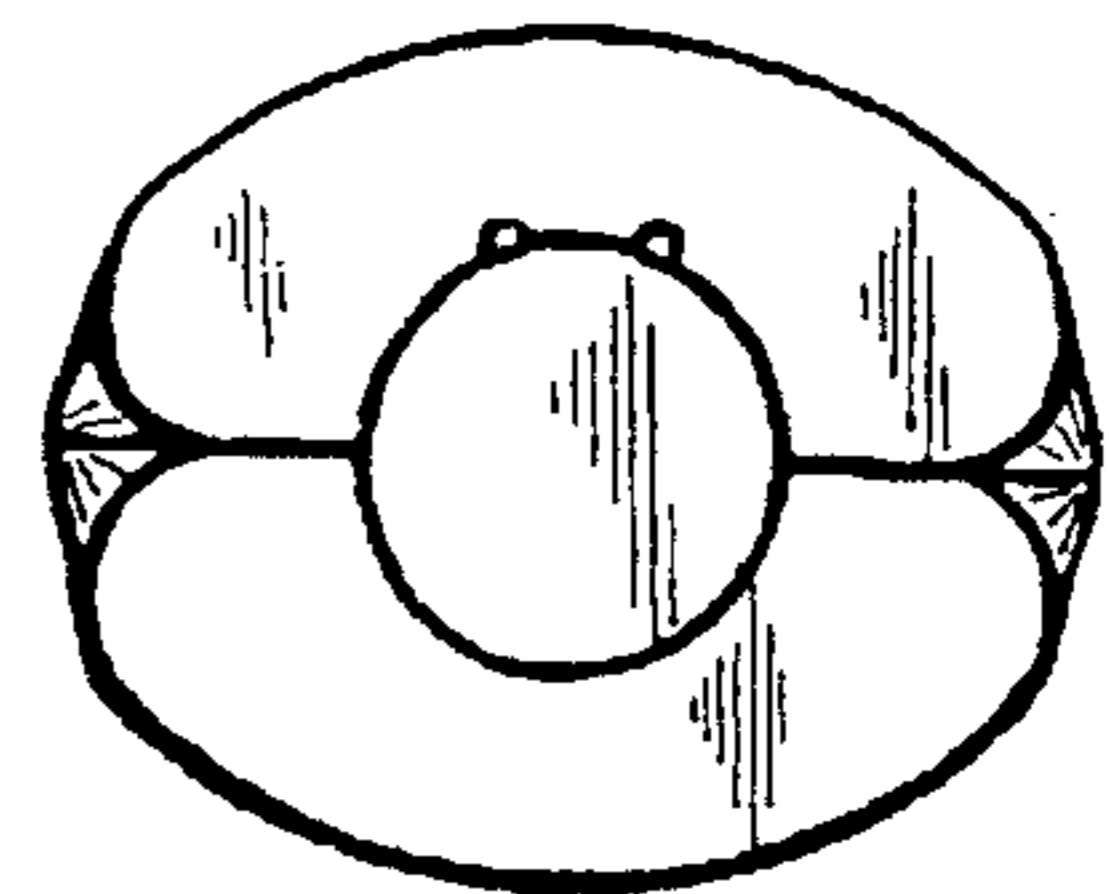

FIG. 7

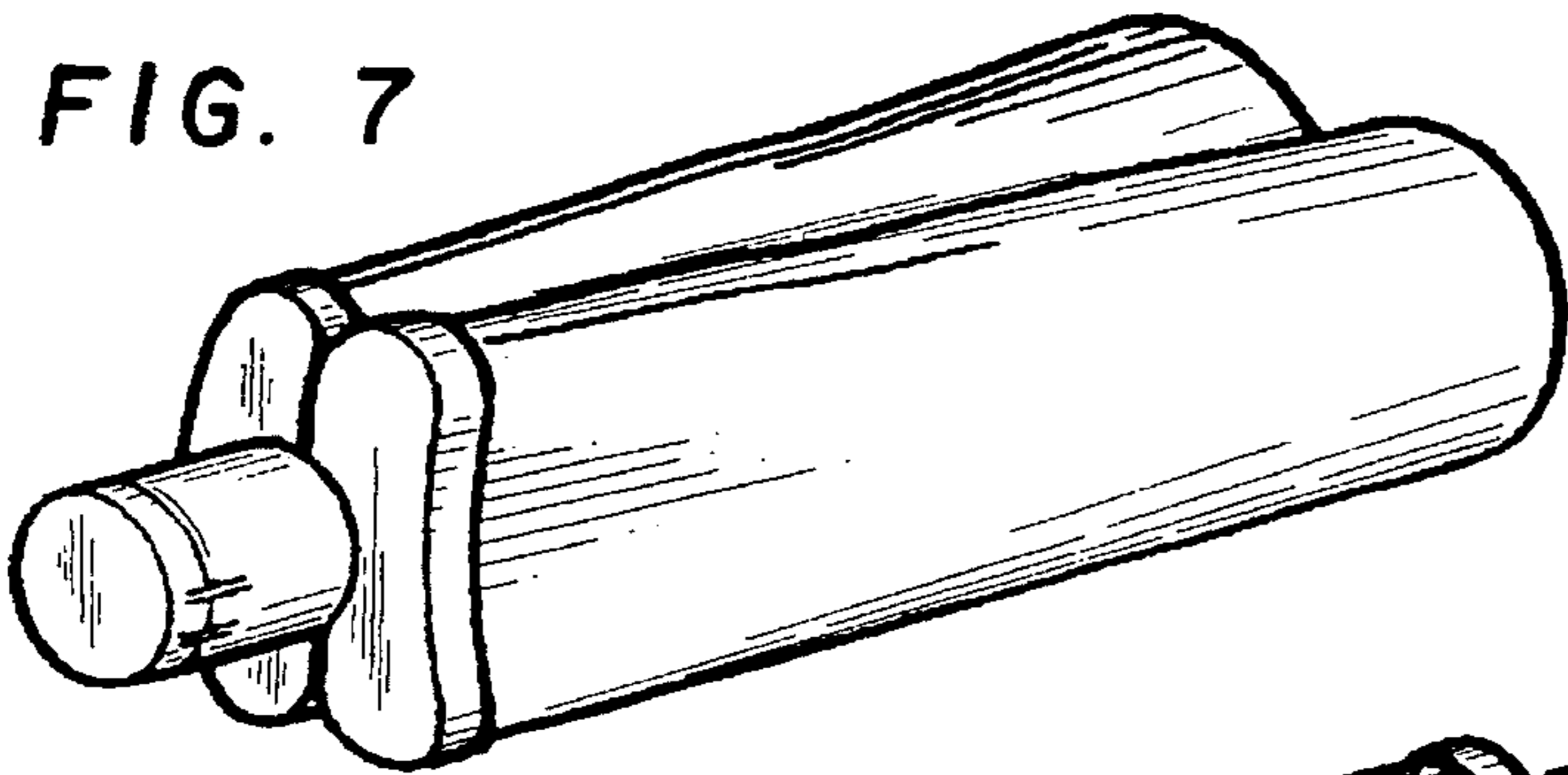

FIG. 8

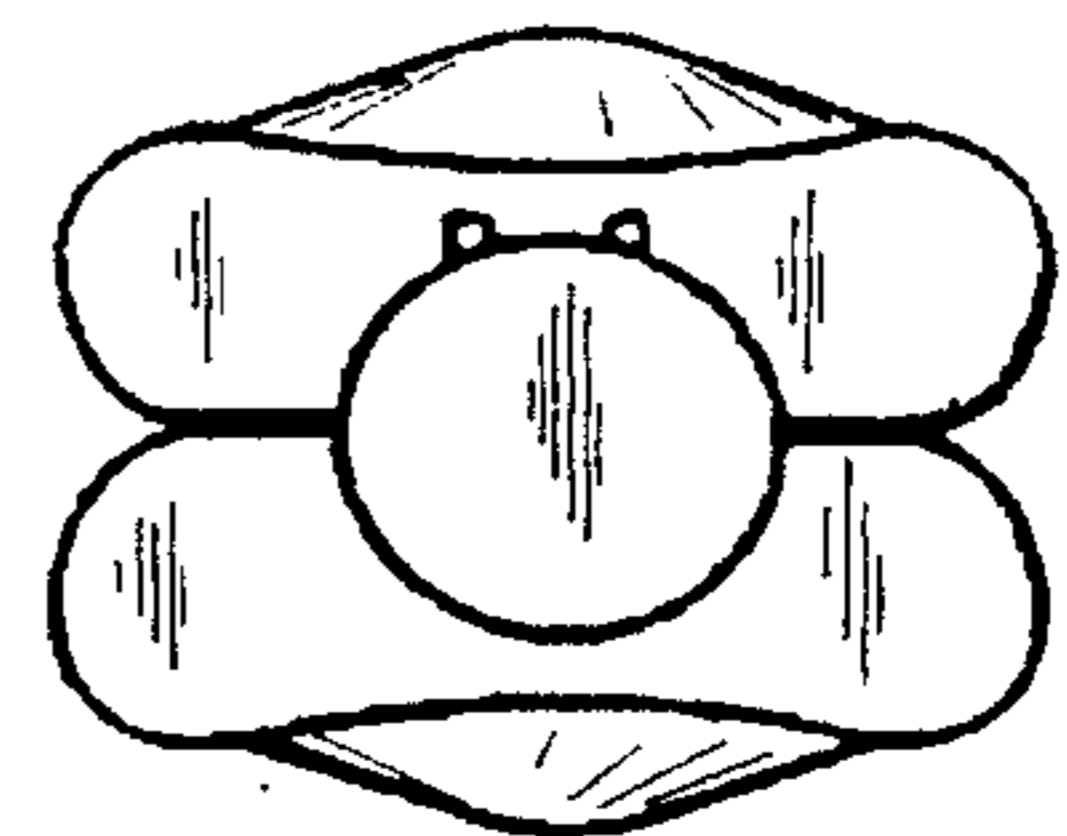
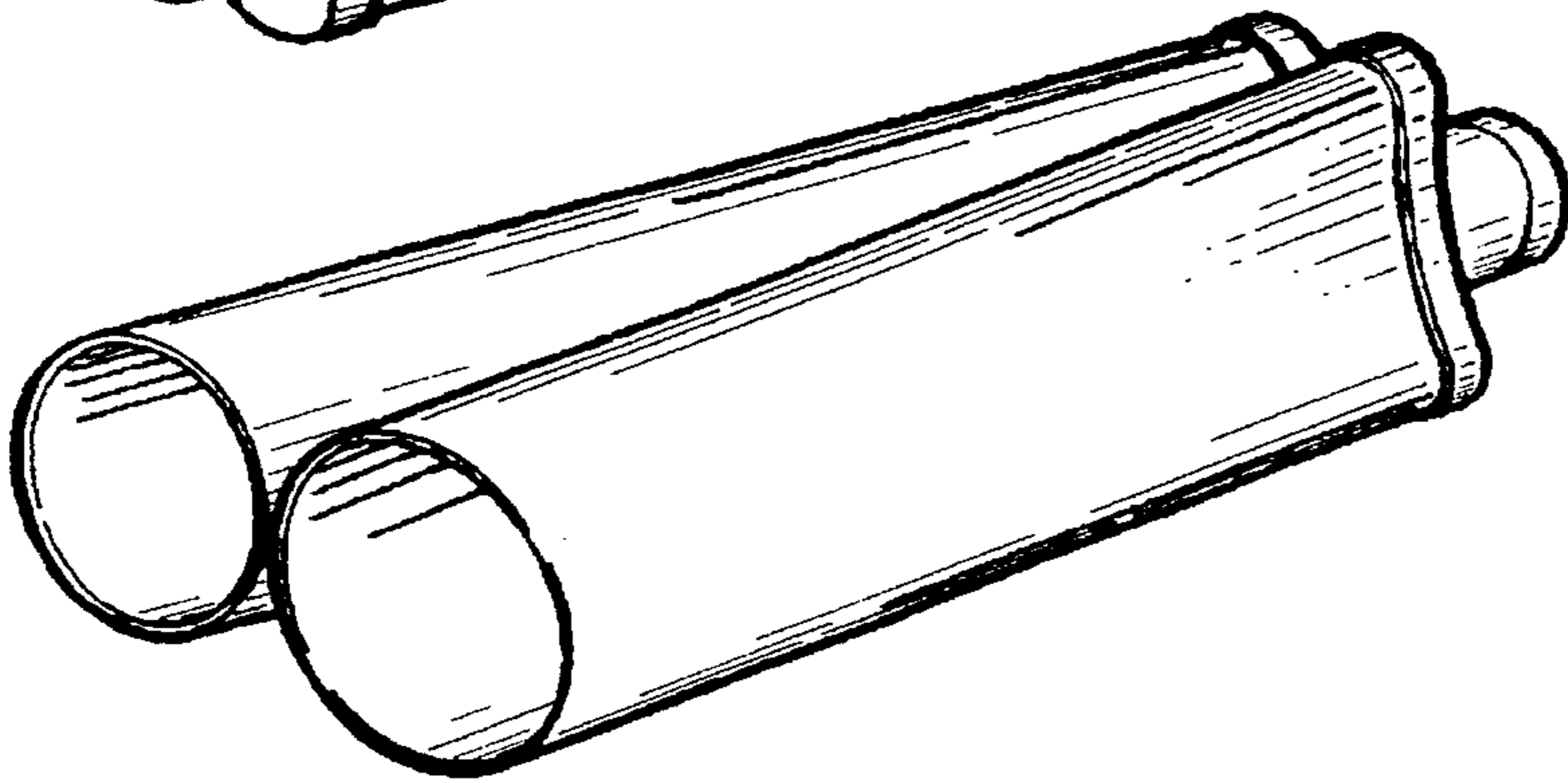

FIG. 9

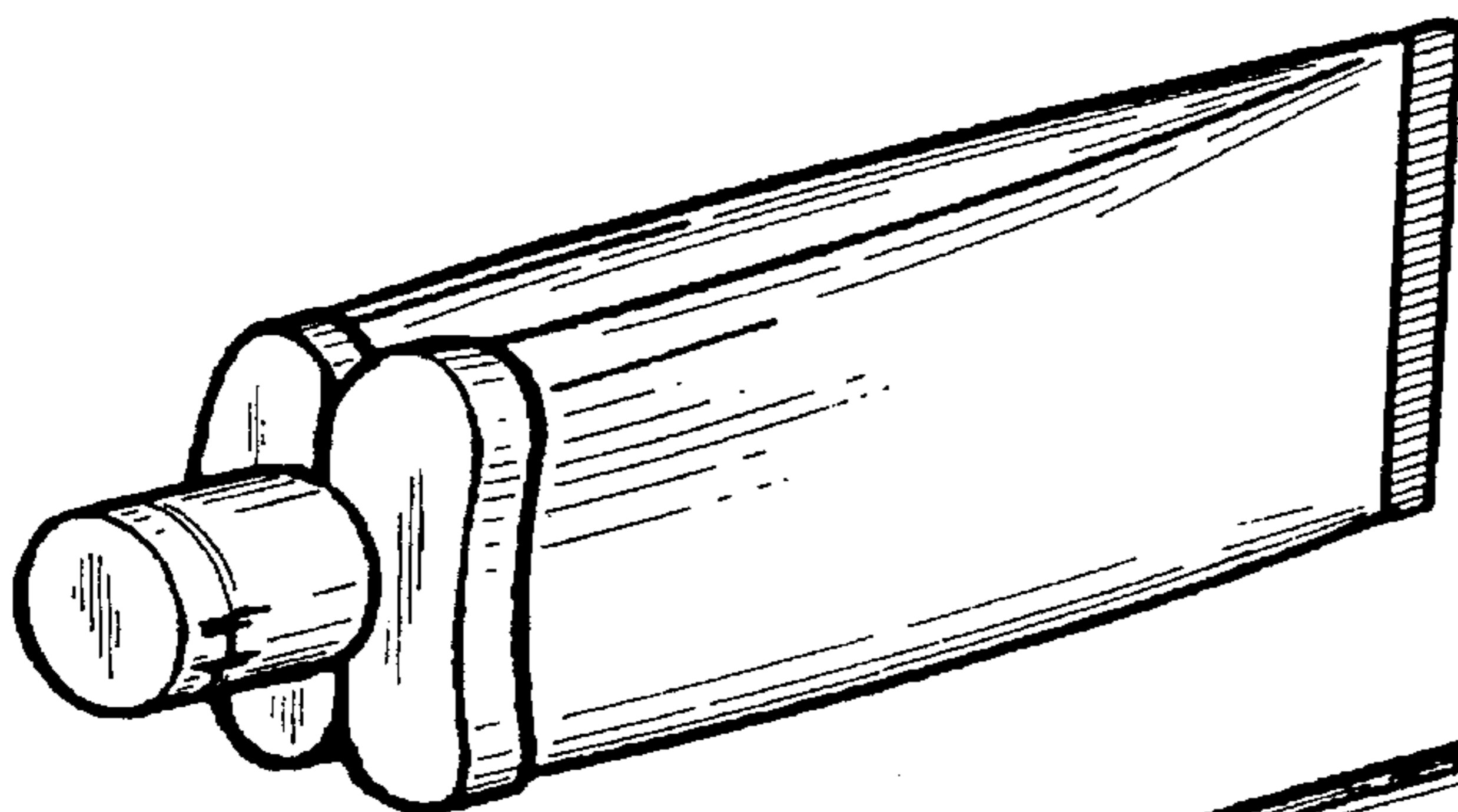

FIG. 10

FIG. 11

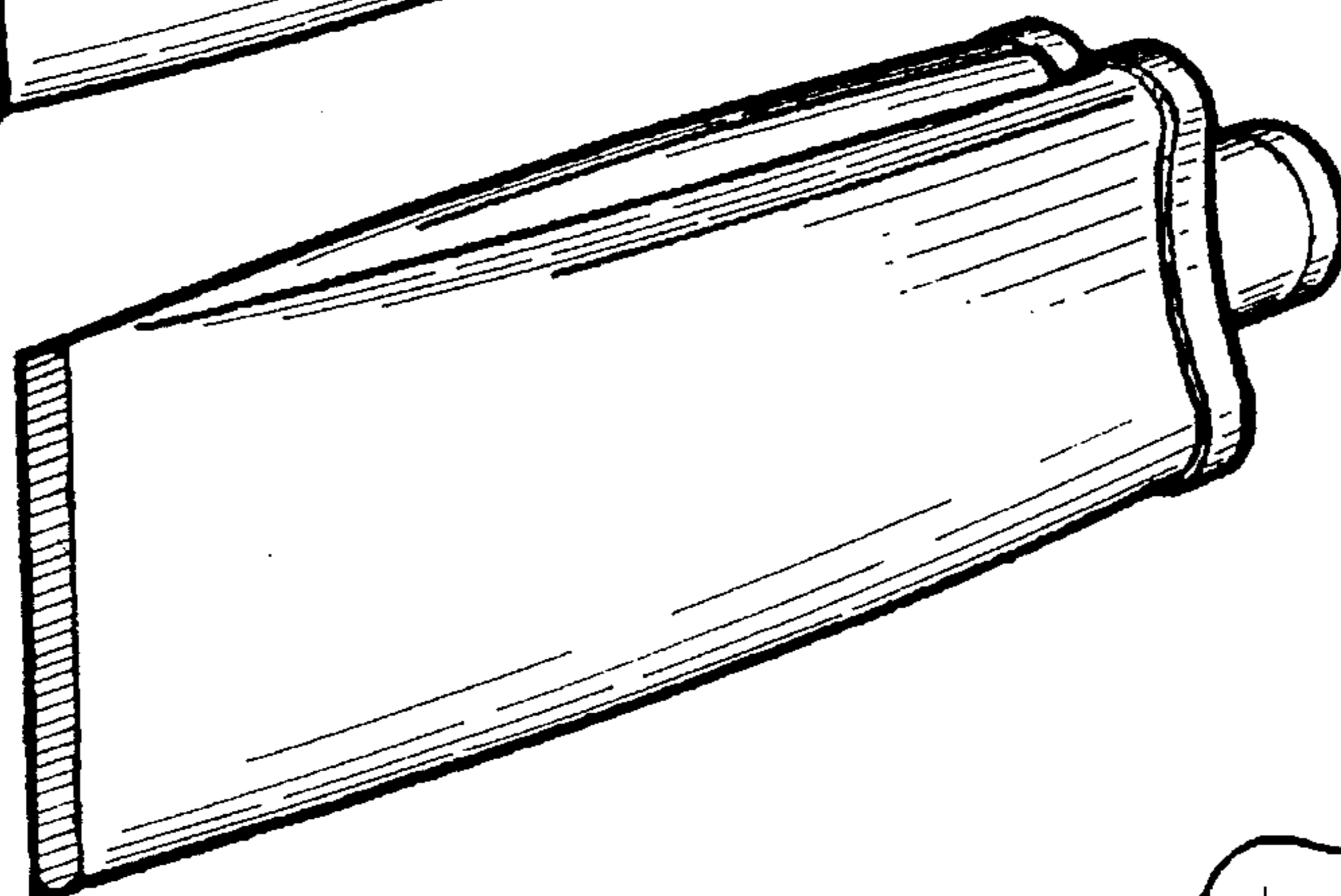

FIG. 12

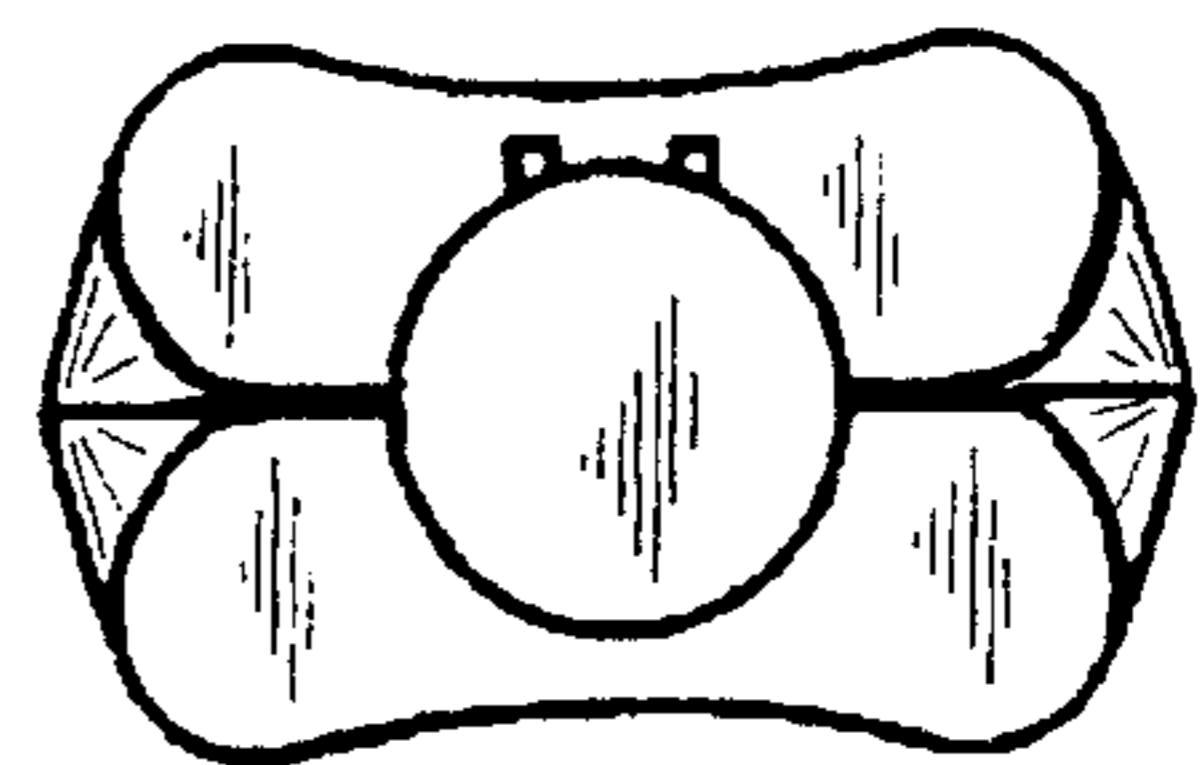

FIG. 13

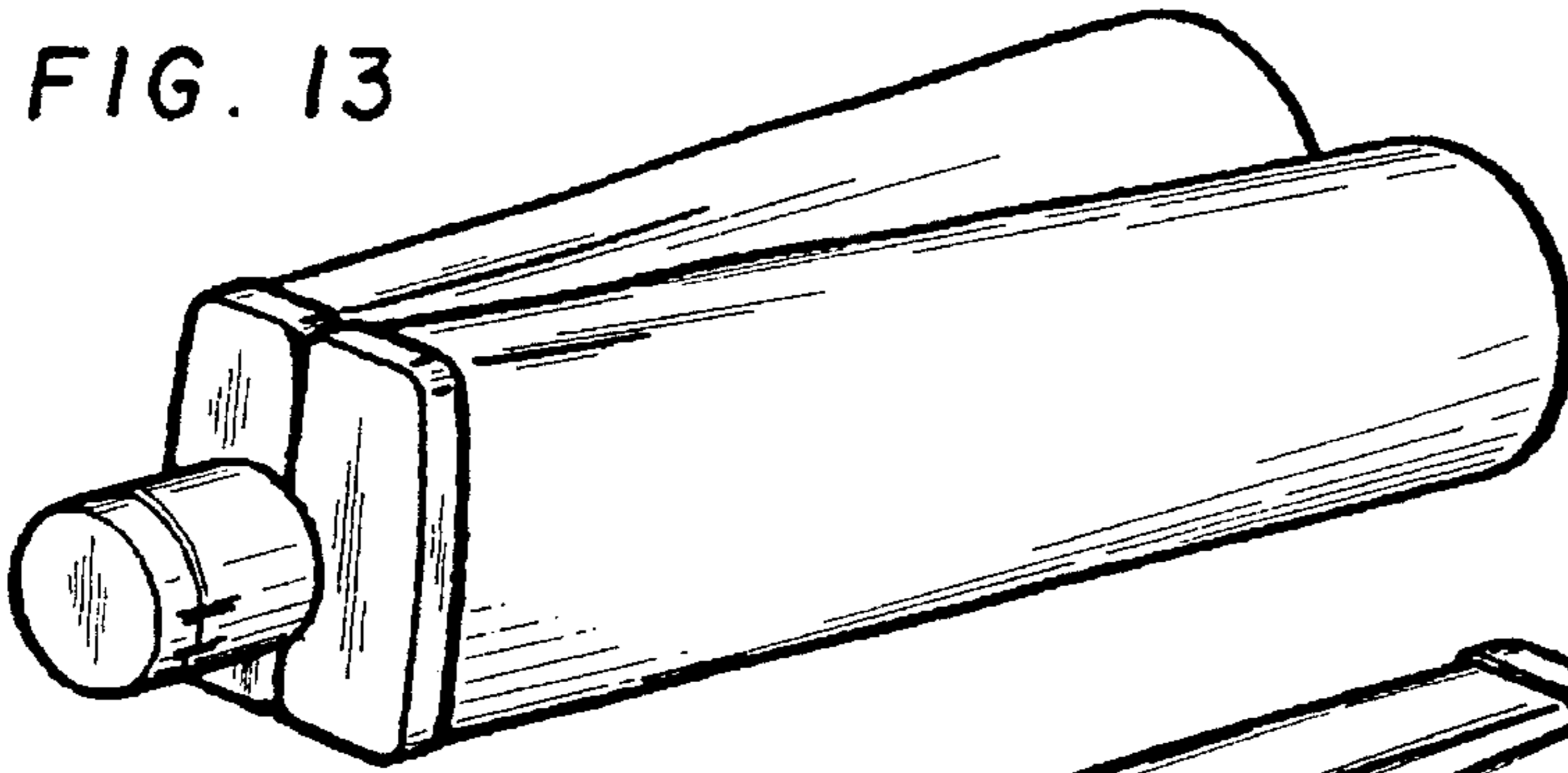

FIG. 14

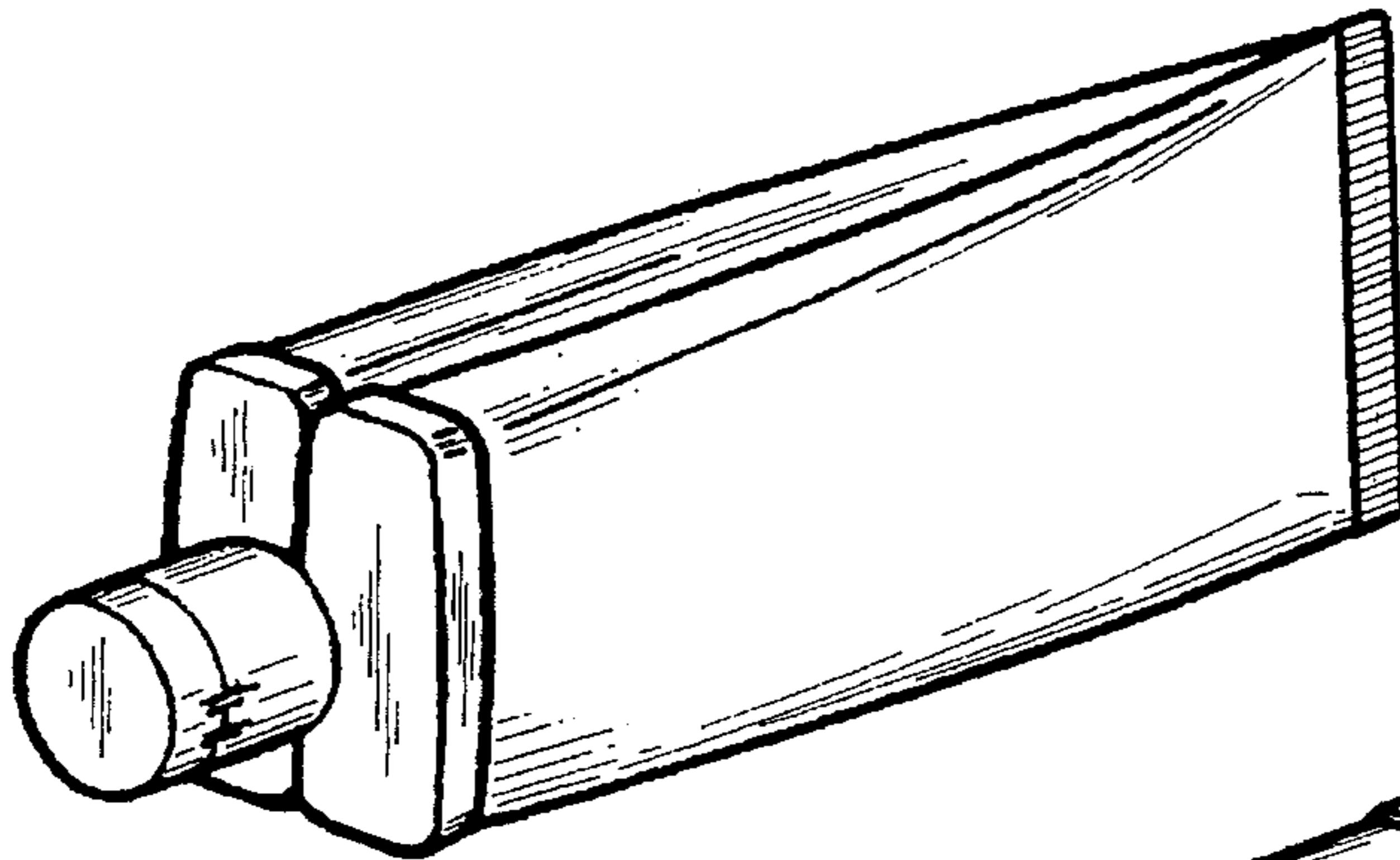
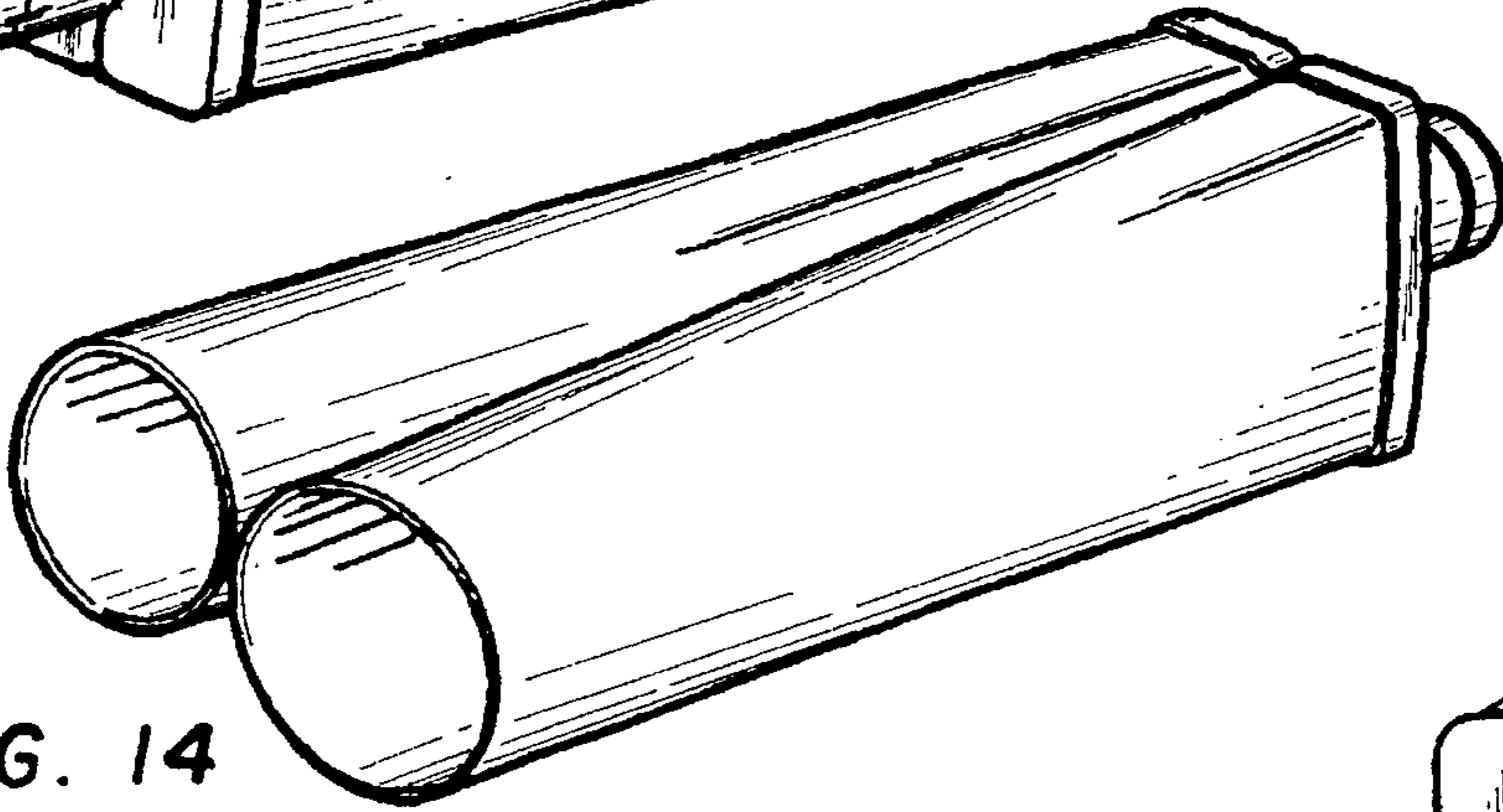

FIG. 16

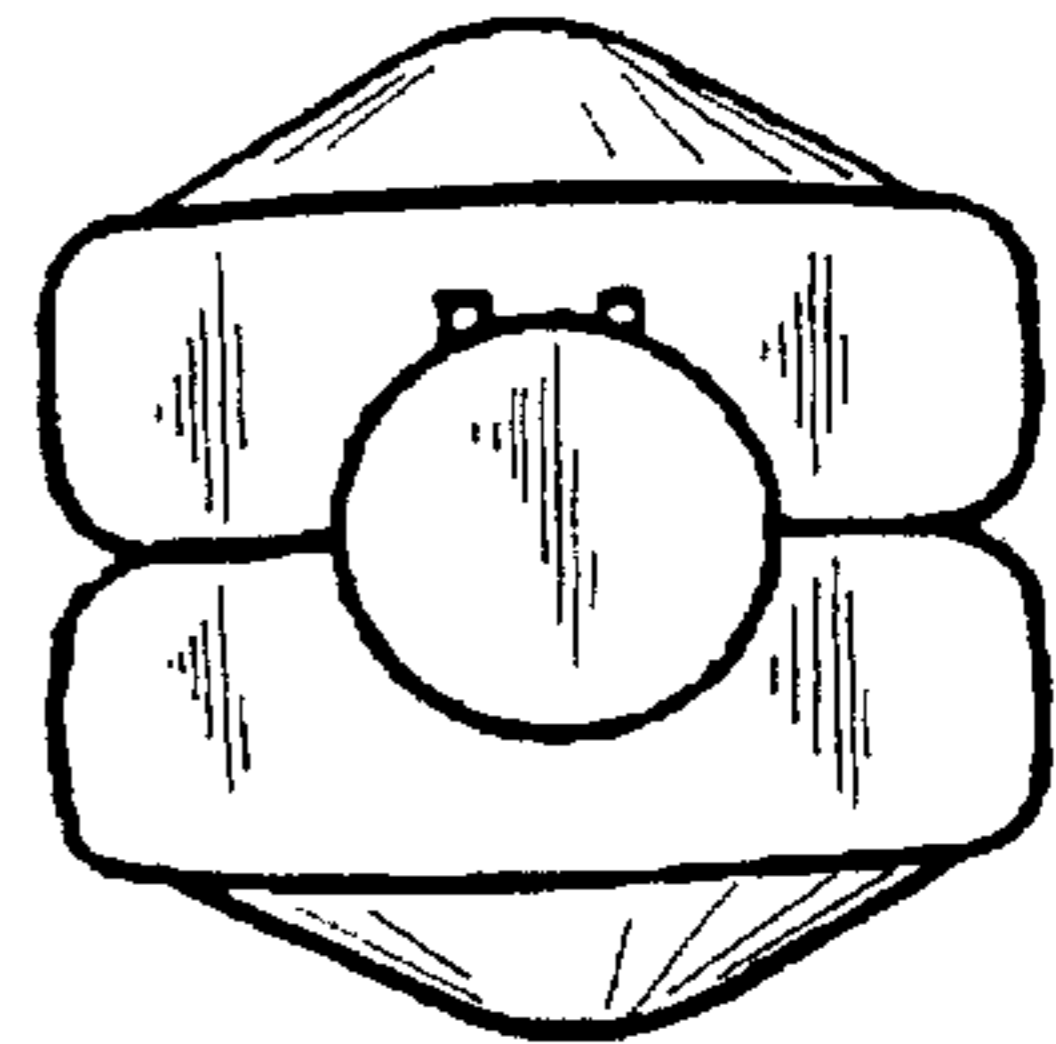
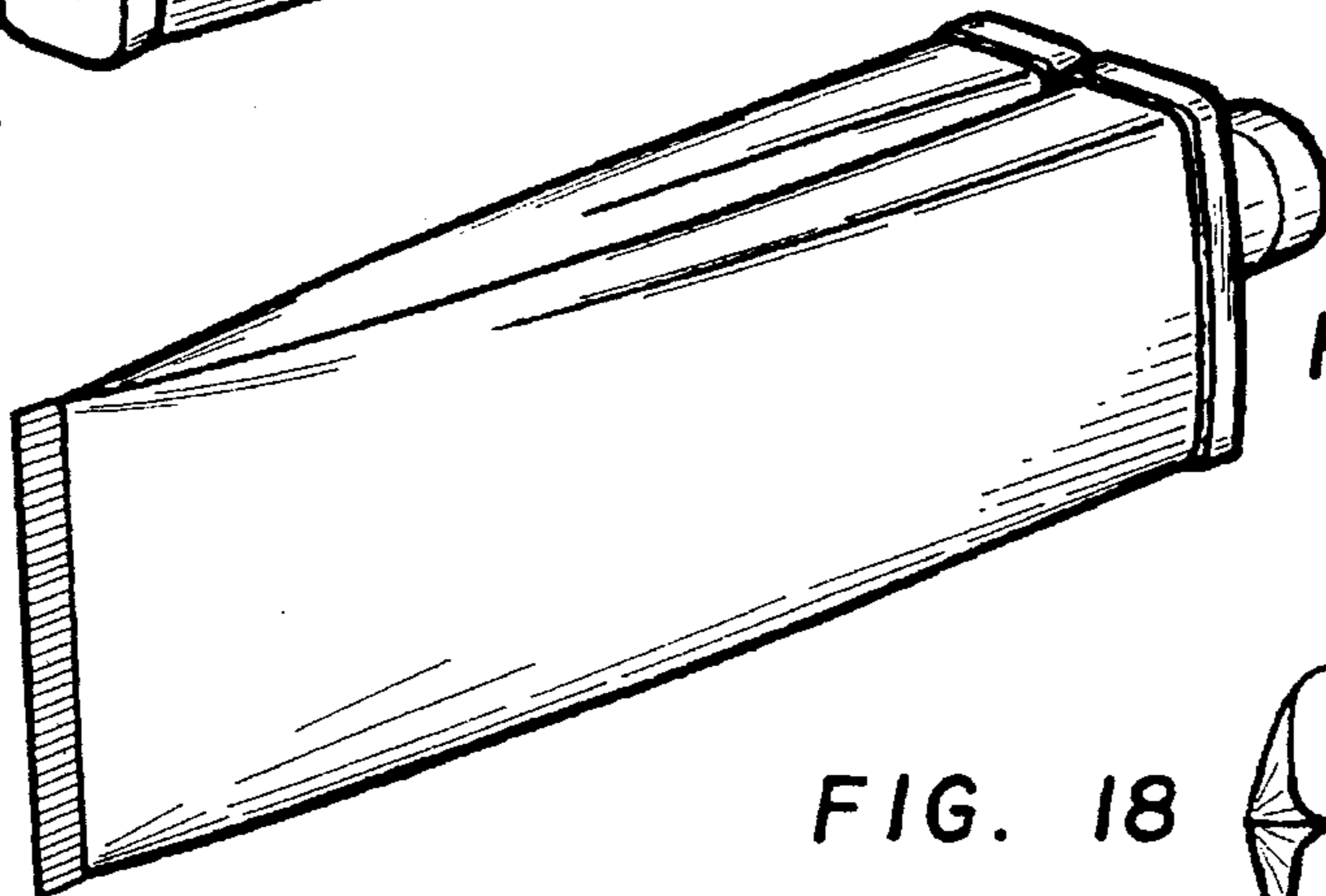

FIG. 15

FIG. 17

FIG. 18

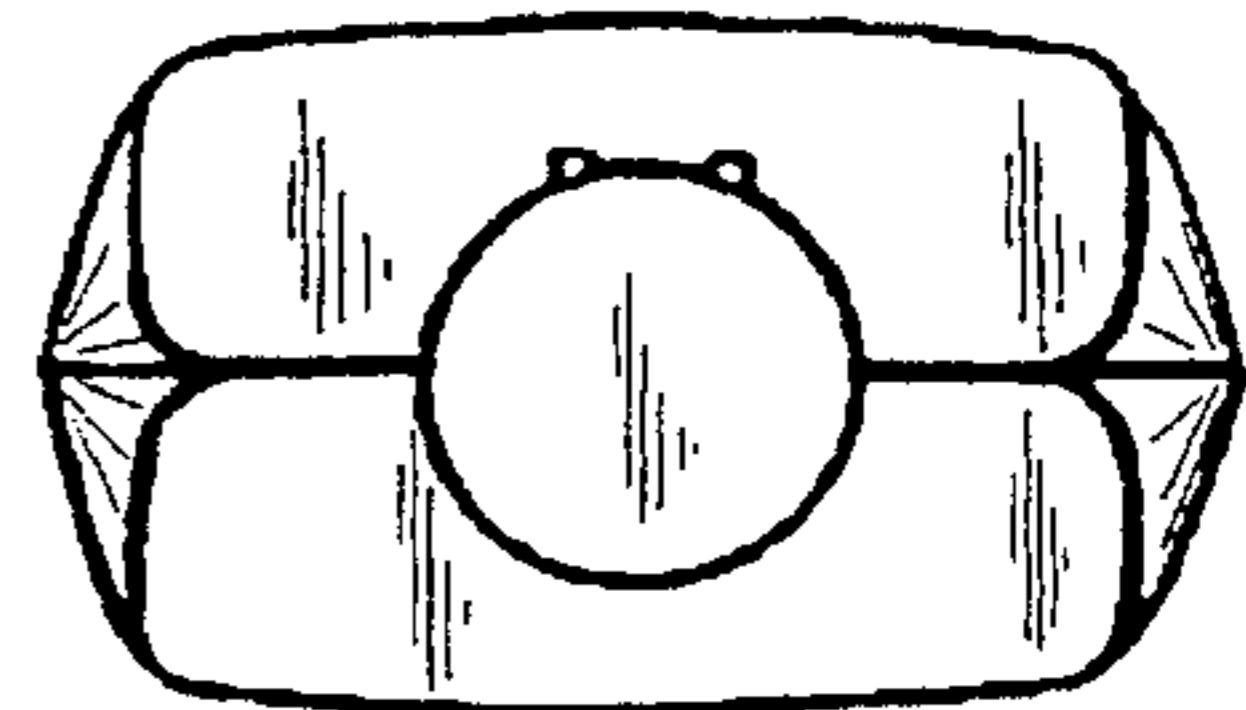

FIG. 19

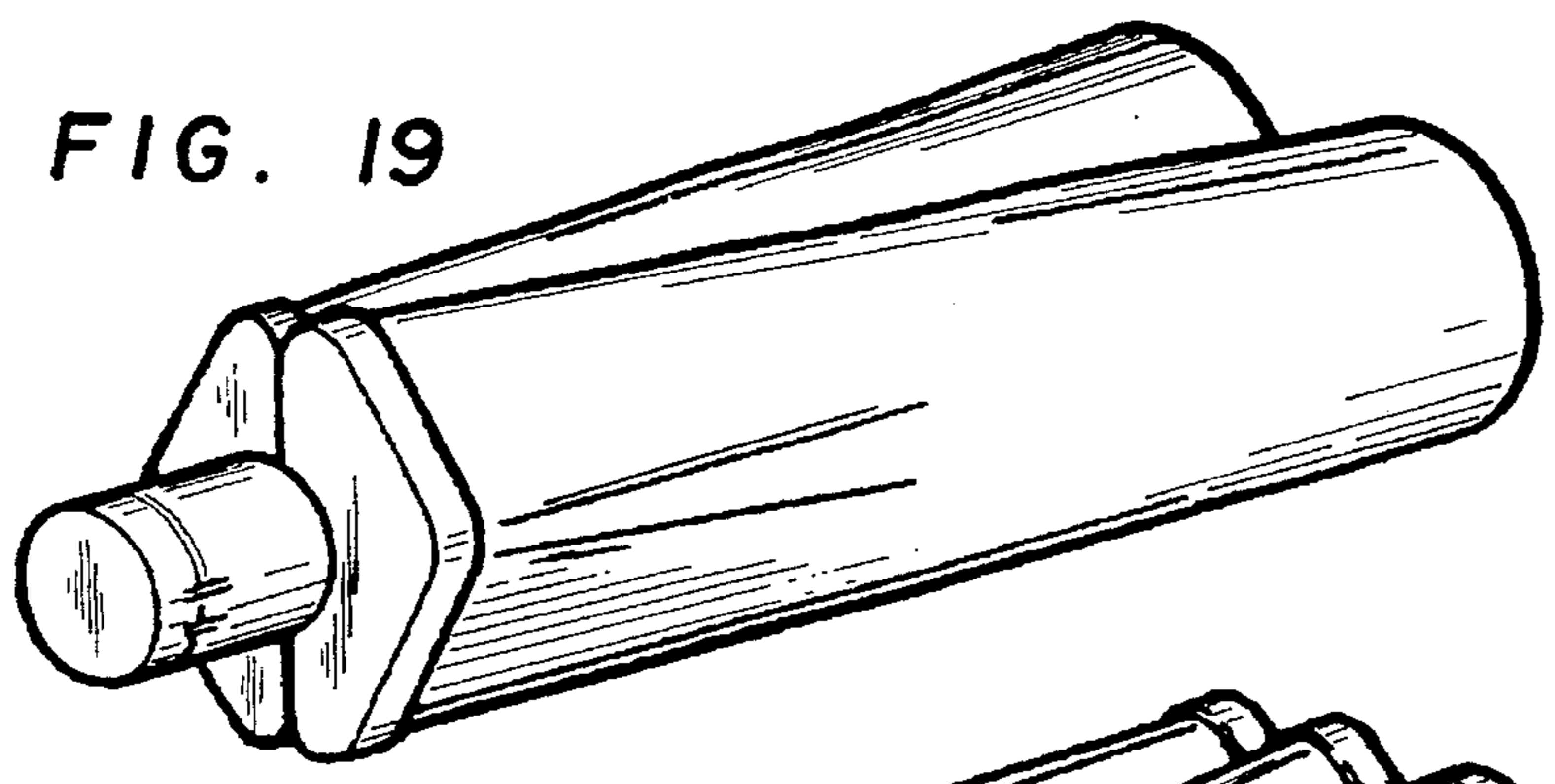

FIG. 20

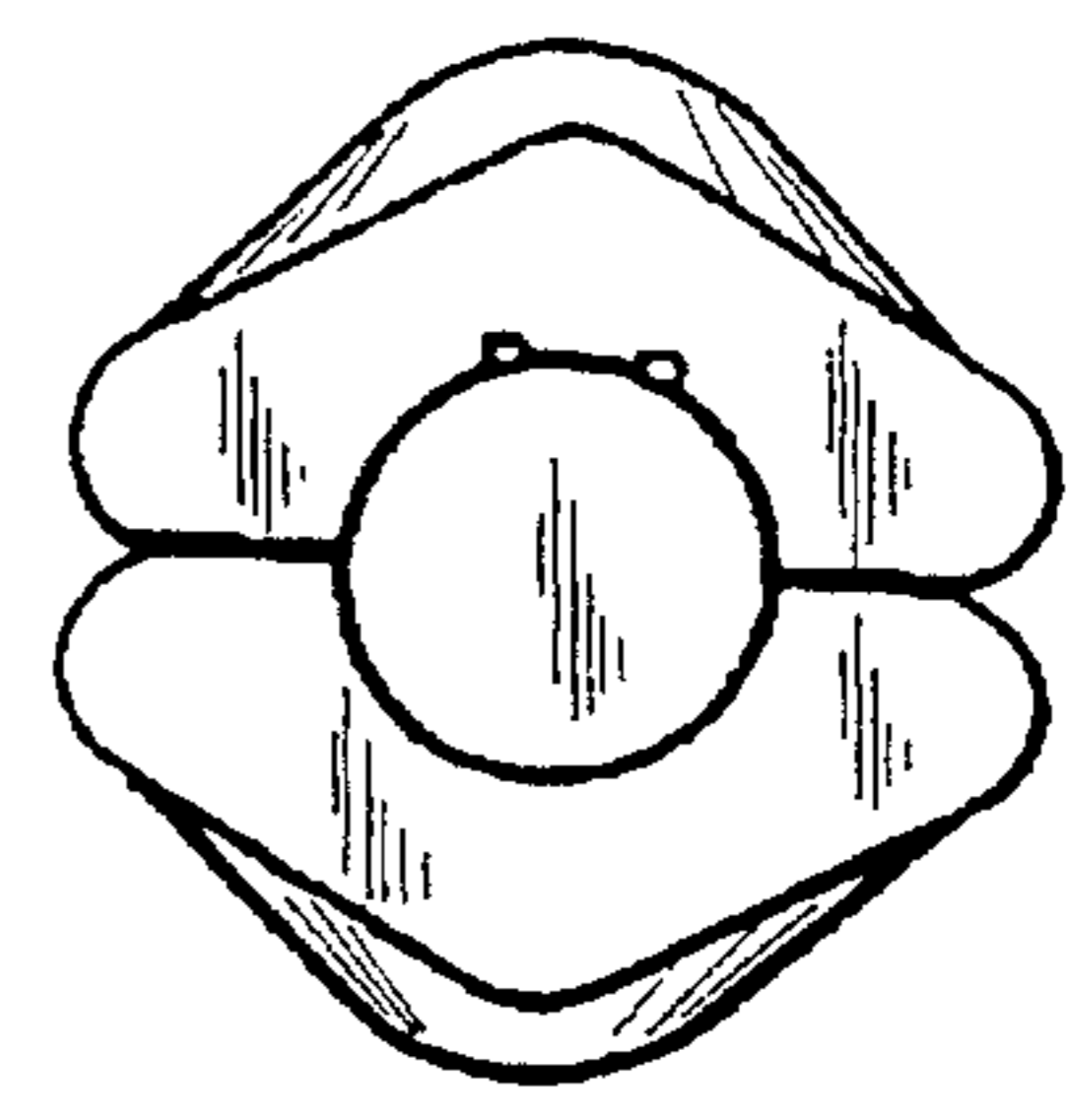
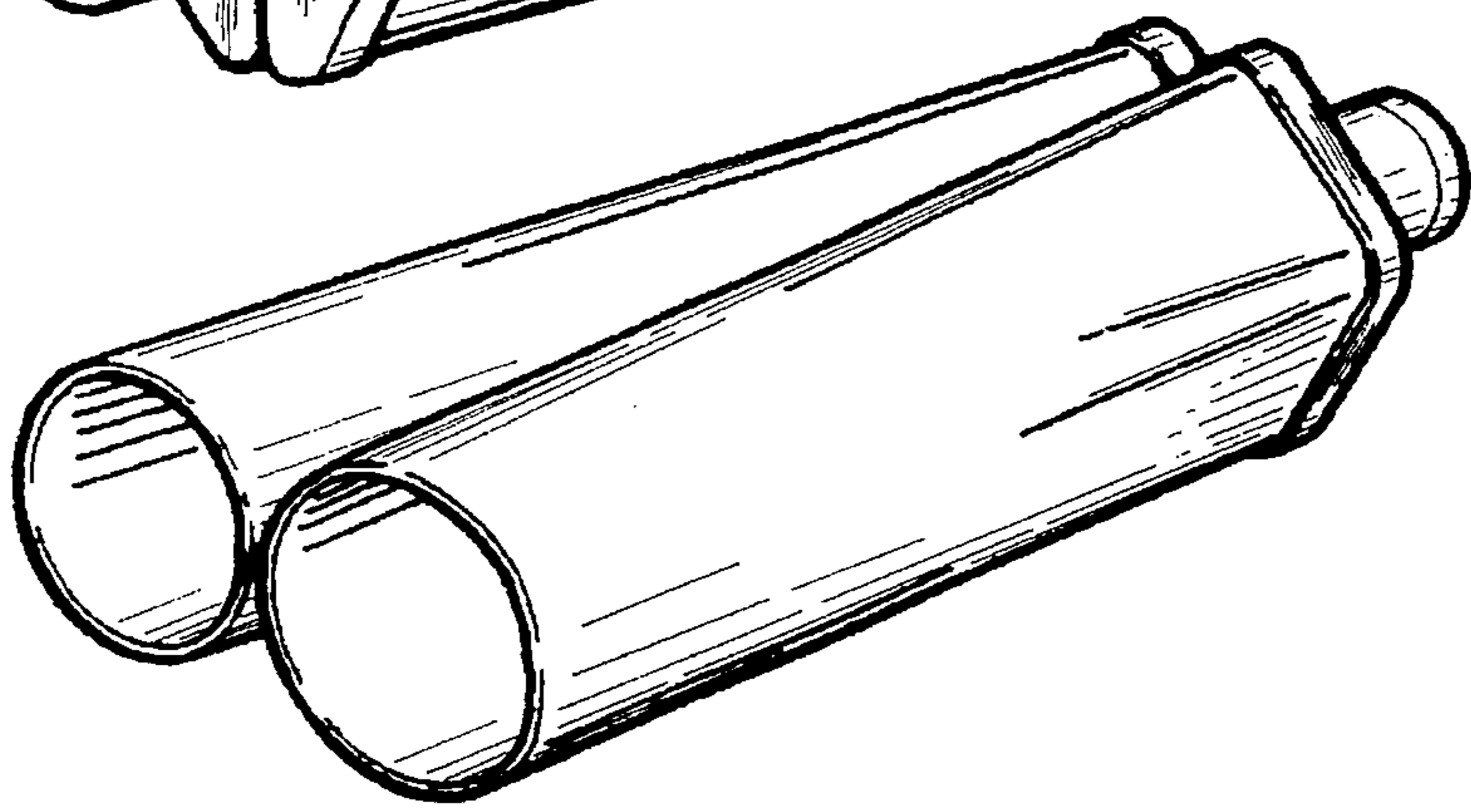

FIG. 21

FIG. 22

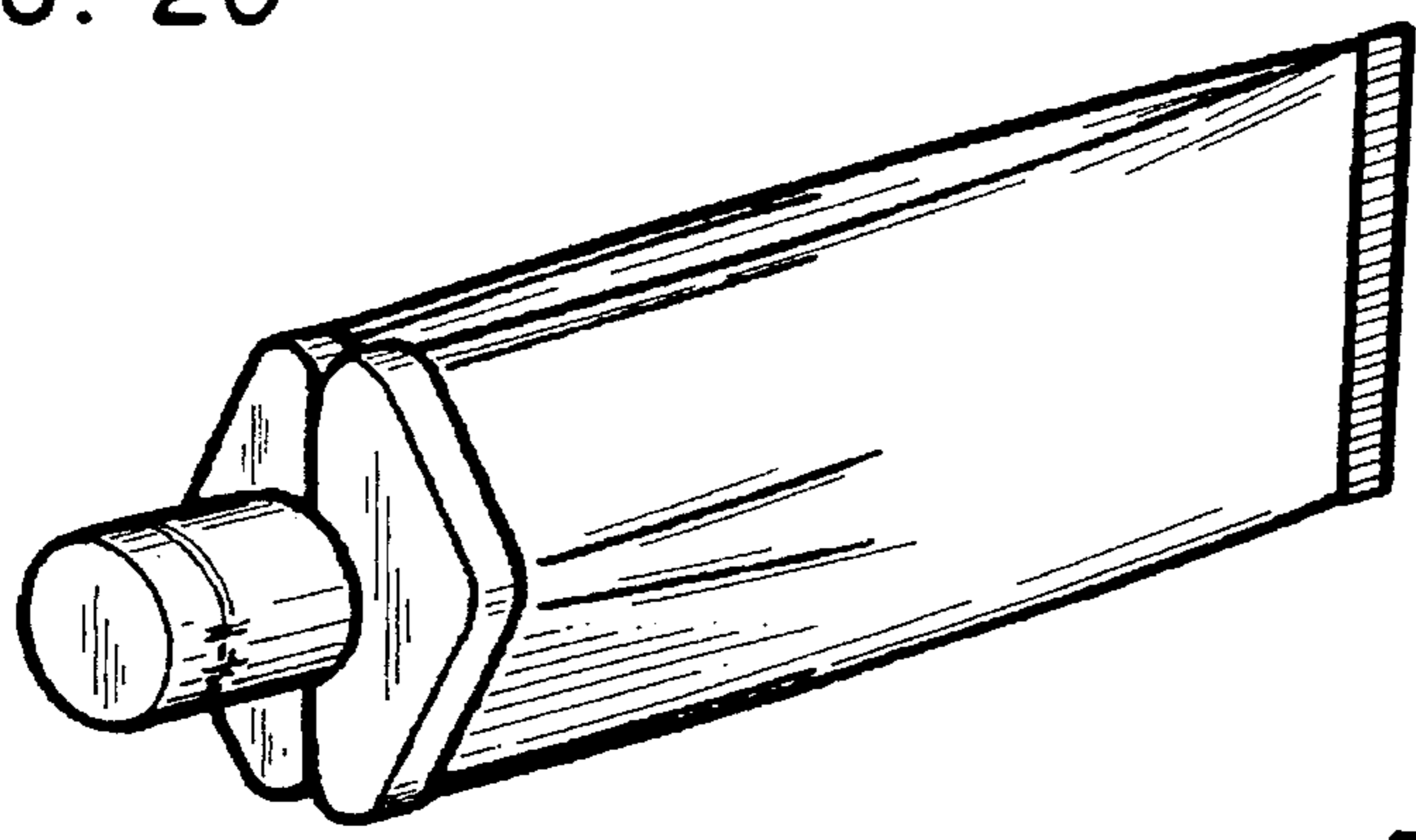

FIG. 23

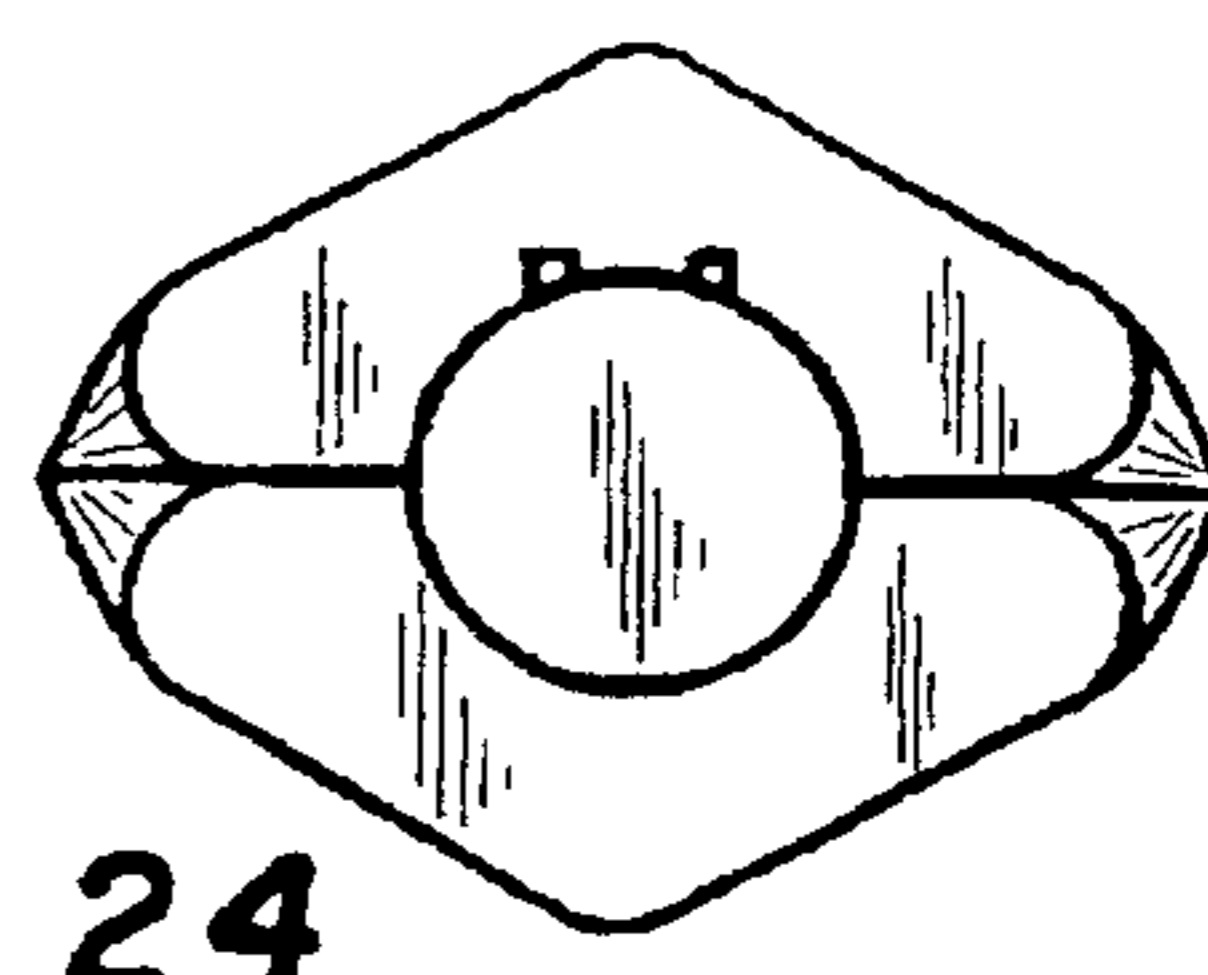
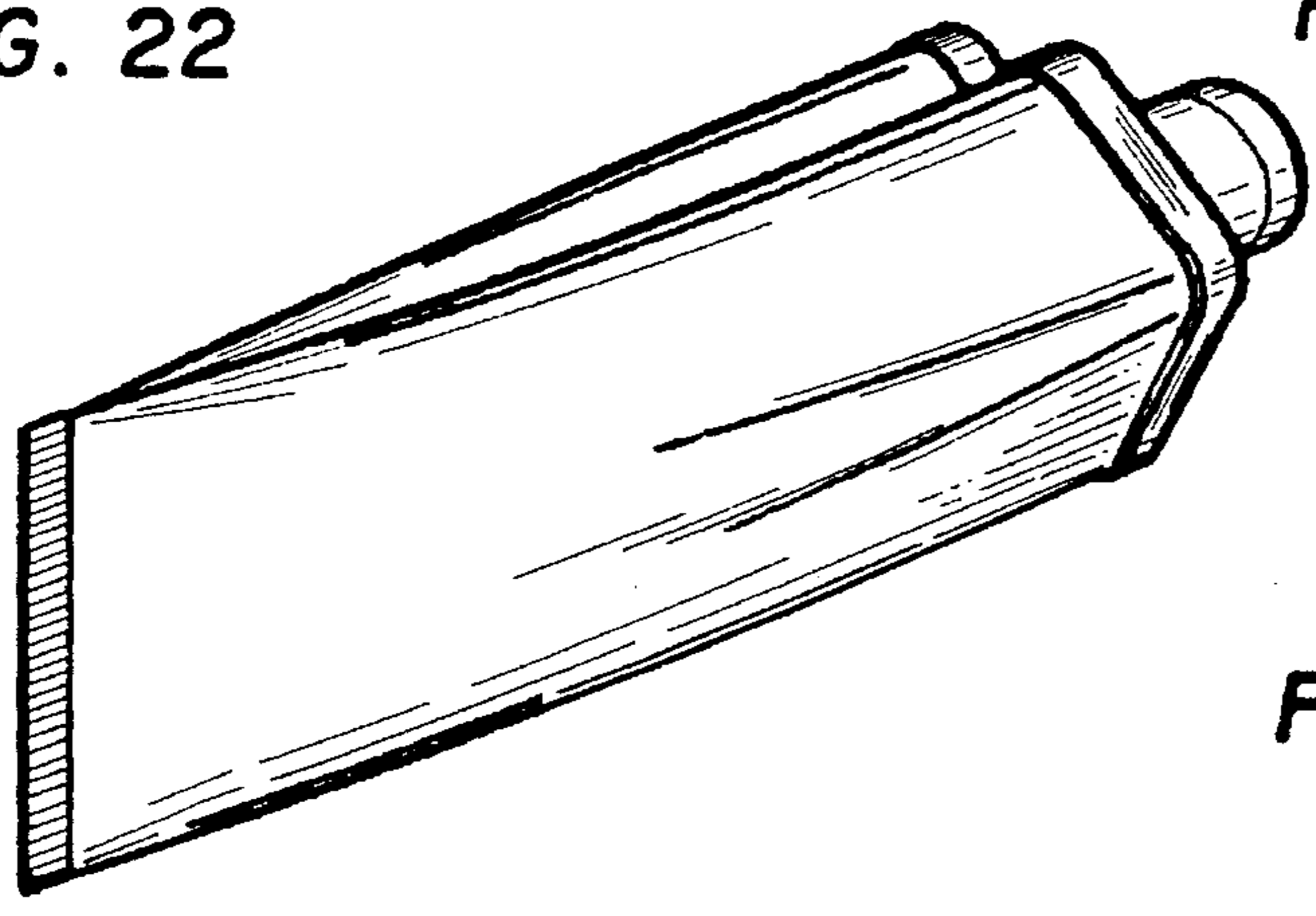

FIG. 24