



US00D374166S

United States Patent [19]

[11] Patent Number: **Des. 374,166**

Czerwinski et al.

[45] Date of Patent: ****Oct. 1, 1996**

[54] CASSETTE HOSE REEL

FOREIGN PATENT DOCUMENTS

[75] Inventors: **Frank G. Czerwinski**, Parkersburg, W. Va.; **Steven F. Brooker**, Marietta, Ohio; **Kenneth J. Spear**, Vienna, W. Va.

1104000 2/1968 United Kingdom .

Primary Examiner—Brian N. Vinson
Attorney, Agent, or Firm—Cushman Darby & Cushman

[73] Assignee: **O. Ames Co.**, Parkersburg, W. Va.

[57] CLAIM

[**] Term: **14 Years**

The ornamental design for a cassette hose reel, as shown and described.

[21] Appl. No.: **41,437**

DESCRIPTION

[22] Filed: **Jul. 14, 1995**

[52] U.S. Cl. **D8/359**

[58] Field of Search D8/358, 359; 242/159, 242/370, 398, 395, 405, 405.3

FIG. 1 is a front elevational view of the cassette hose reel, showing our new design;

FIG. 2 is a top plan view thereof;

FIG. 3 is a rear elevational view thereof;

FIG. 4 is a bottom plan view thereof;

FIG. 5 is a left hand end view thereof;

FIG. 6 is a right hand end view thereof; and,

FIG. 7 is a perspective view thereof looking toward the left end and front of the cassette hose reel.

[56] References Cited

U.S. PATENT DOCUMENTS

D. 286,503	11/1986	Bobovniczky	D8/359
D. 289,492	4/1987	Clivio et al.	D8/359
D. 352,232	11/1994	Apgar	D8/359
D. 355,584	2/1995	Clivio	D8/359
4,244,536	1/1981	Harrill	242/405.3 X

1 Claim, 4 Drawing Sheets

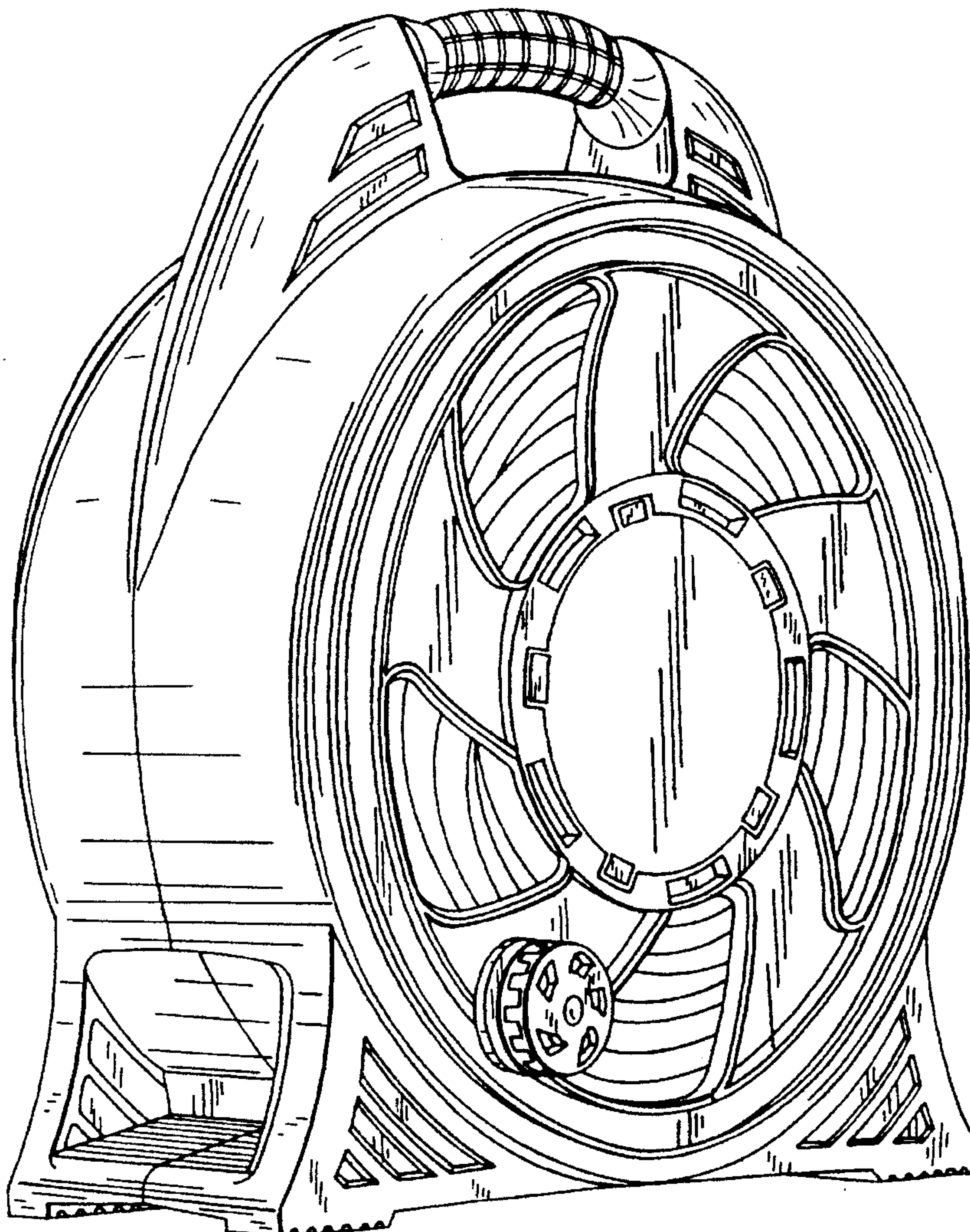

FIG. 1

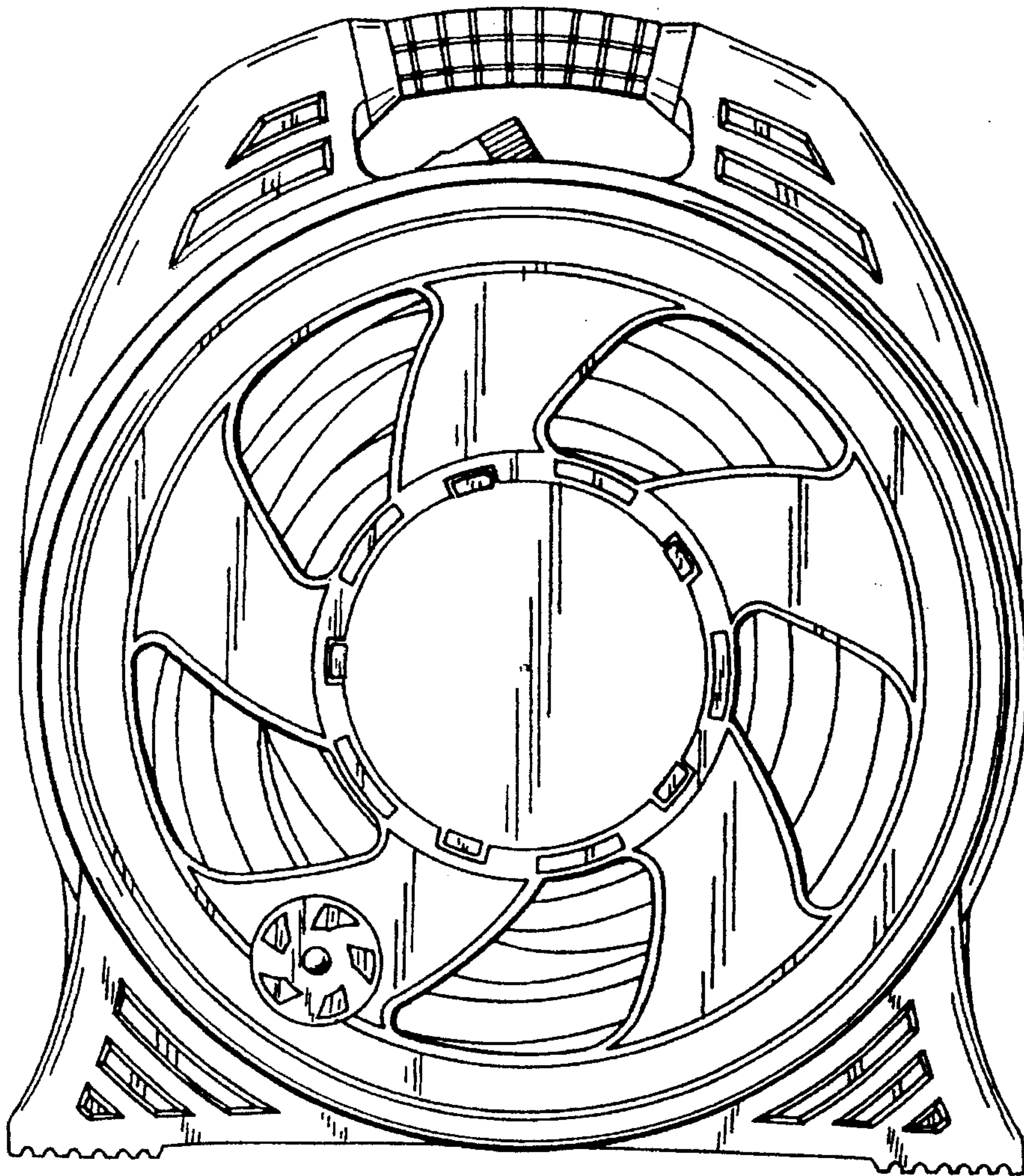

FIG. 2

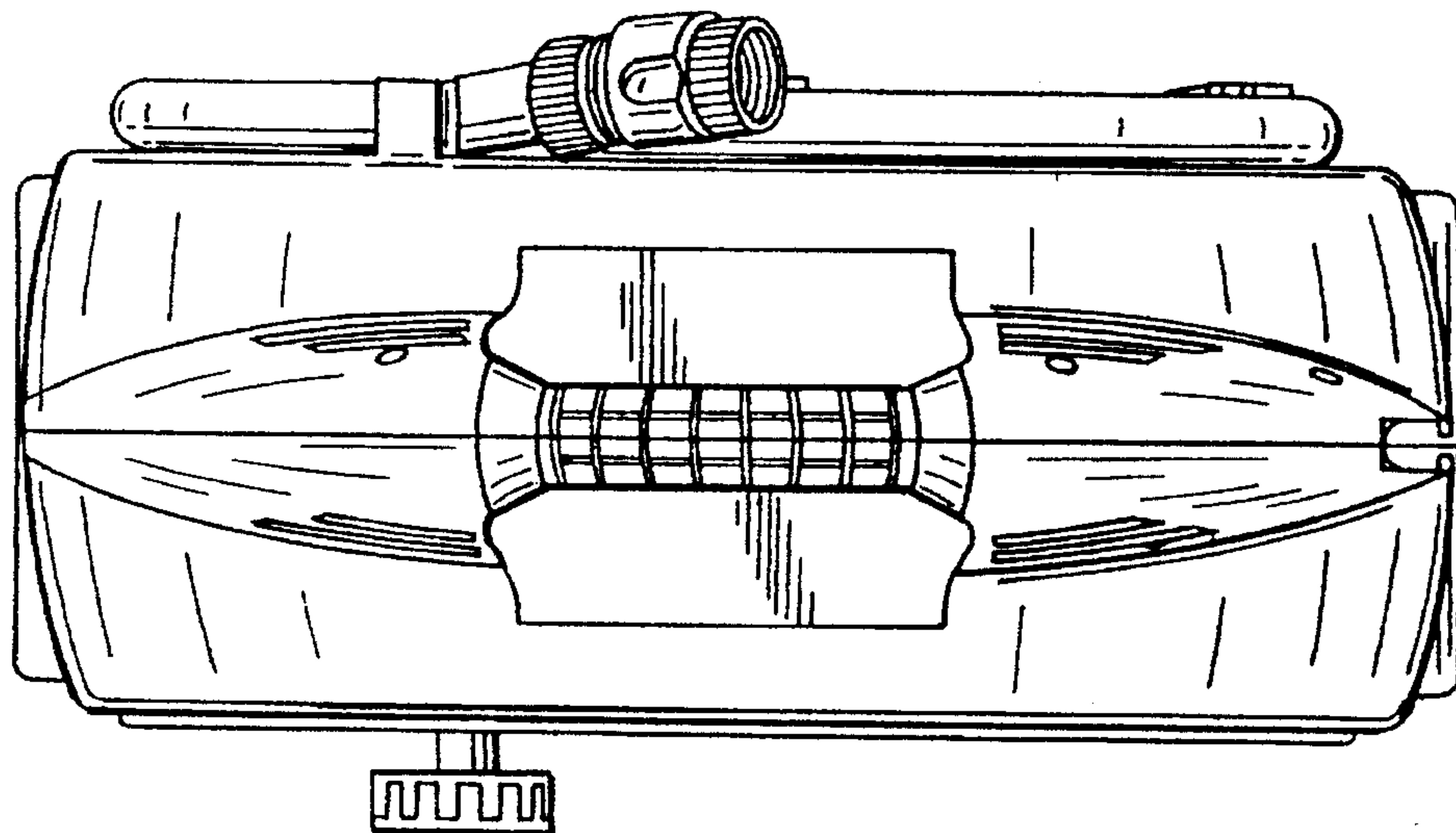

FIG. 3

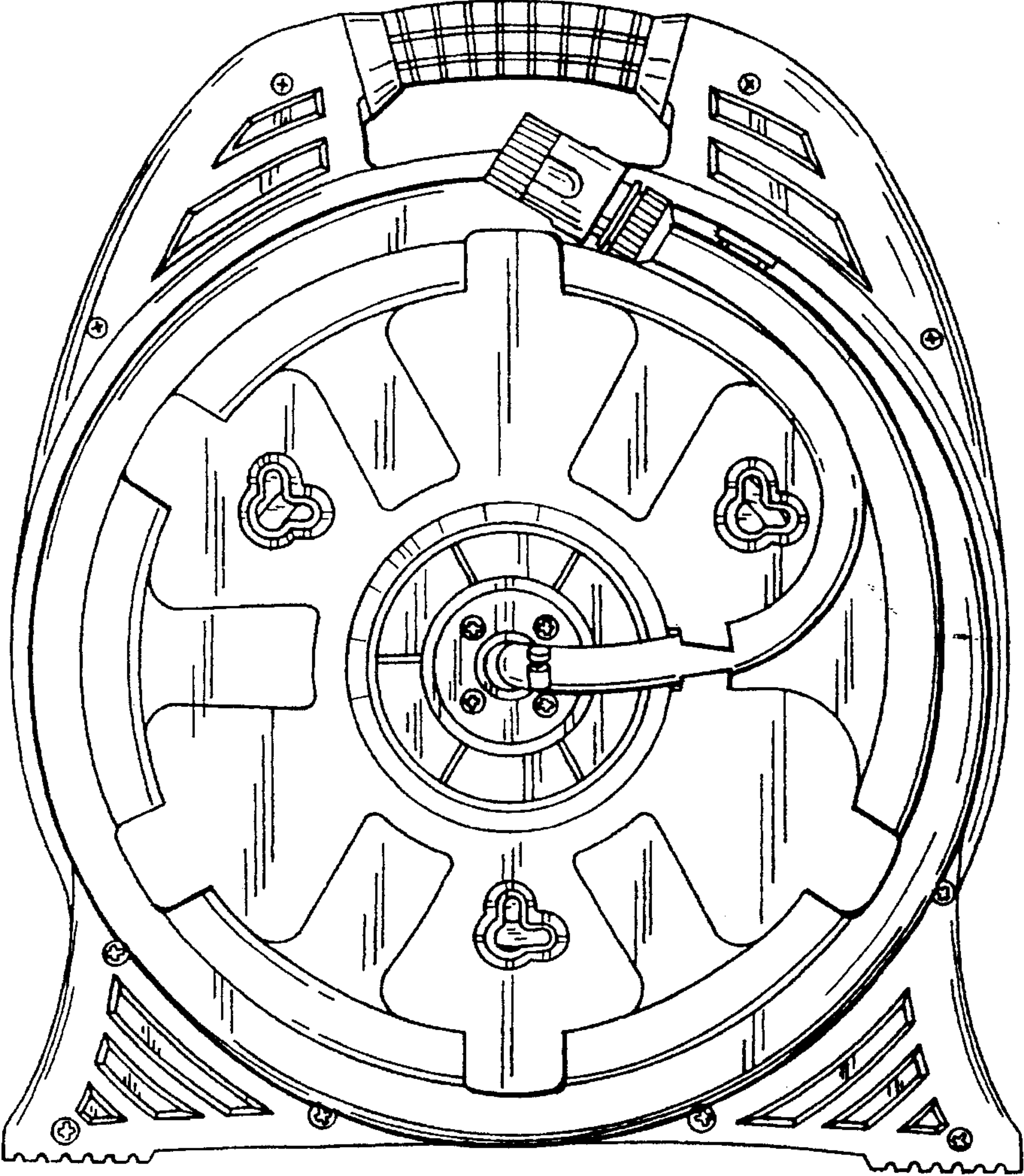

FIG. 4

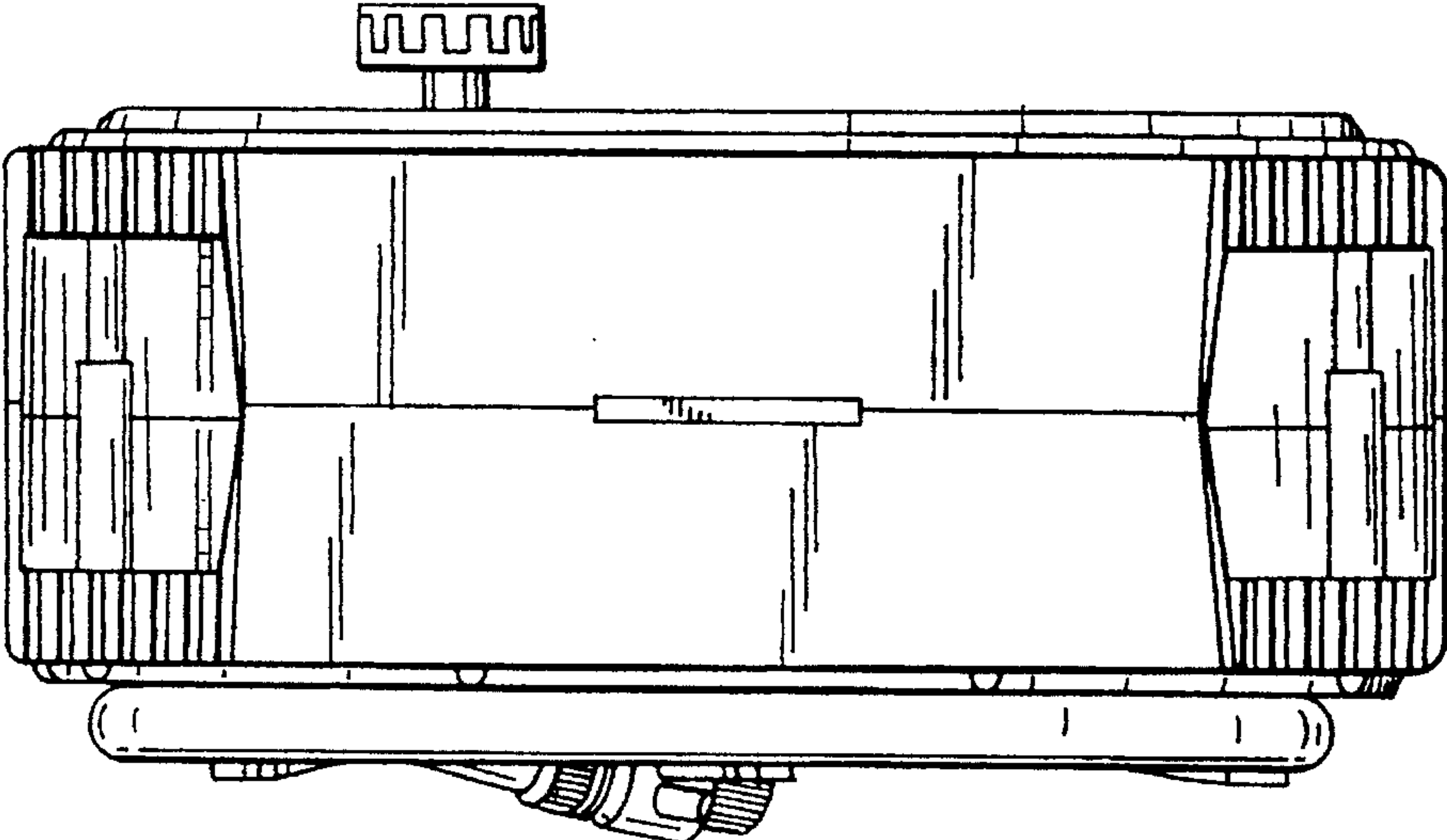

FIG. 6

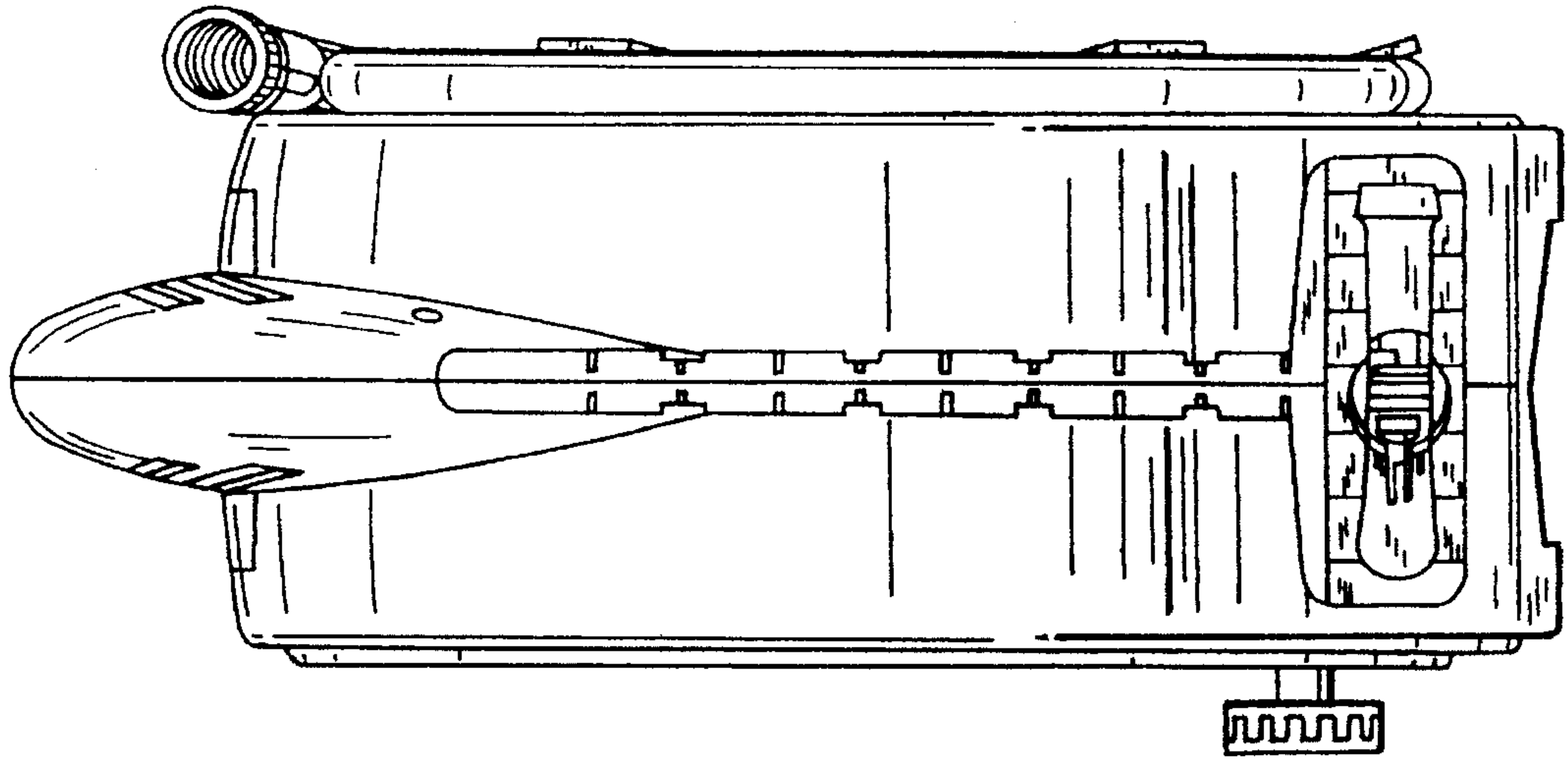

FIG. 5

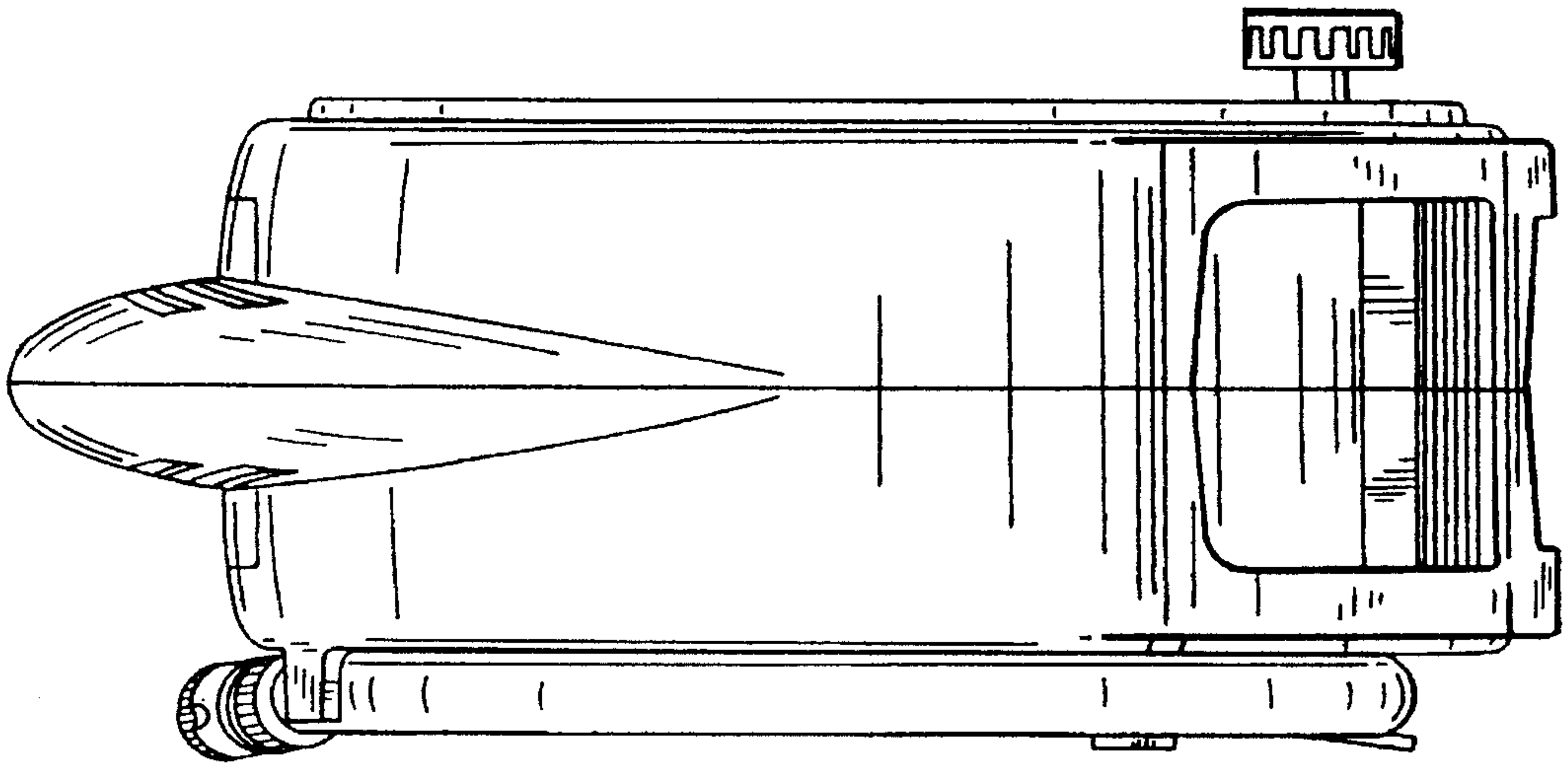

FIG. 7

