



US00D374163S

United States Patent [19]

[11] Patent Number: **Des. 374,163**

Wahlén

[45] Date of Patent: ****Oct. 1, 1996**

[54] LATCH ASSEMBLY

[75] Inventor: **Kent Wahlén**, Edsbyn, Sweden

[73] Assignee: **NEFAB AB**, Alfta, Sweden

[**] Term: **14 Years**

[21] Appl. No.: **45,382**

[22] Filed: **Oct. 18, 1995**

[30] Foreign Application Priority Data

Apr. 20, 1995 [SE] Sweden 95-0816

[52] U.S. Cl. **D8/331**

[58] Field of Search D8/330-331, 335,
D8/342, 344-345; 292/253, 137, 145, 147

[56] References Cited

U.S. PATENT DOCUMENTS

| | | | | |
|------------|---------|-----------|-------|-----------|
| D. 298,732 | 11/1988 | Pihl | | D8/331 |
| 1,210,967 | 1/1917 | Miller | | 292/253 |
| 1,809,994 | 6/1931 | Templeton | | 292/253 |
| 2,537,801 | 1/1951 | Swatsick | | 292/253 X |
| 4,024,977 | 5/1977 | Rowley | | 292/253 X |
| 4,371,092 | 2/1983 | Teaque | | 292/253 X |

Primary Examiner—Brian N. Vinson
Attorney, Agent, or Firm—Notaro & Michalos

[57] CLAIM

The ornamental design for a latch assembly, as shown and described.

DESCRIPTION

FIG. 1 is a top, front, and left side perspective view of a latch assembly showing my new design;

FIG. 2 is a bottom, rear, and right side perspective view thereof;

FIG. 3 is a top, front, and left side perspective view of the hasp portion thereof;

FIG. 4 is a bottom, rear, and right side perspective view of the hasp portion thereof;

FIG. 5 is a top, front, and left side perspective view of the tab portion thereof; and,

FIG. 6 is a bottom, rear, and right side perspective view of the tab portion thereof.

The tab portion in FIGS. 3 and 4, and the hasp portion in FIGS. 5 and 6 have been omitted from the views for clarity of illustration.

1 Claim, 1 Drawing Sheet

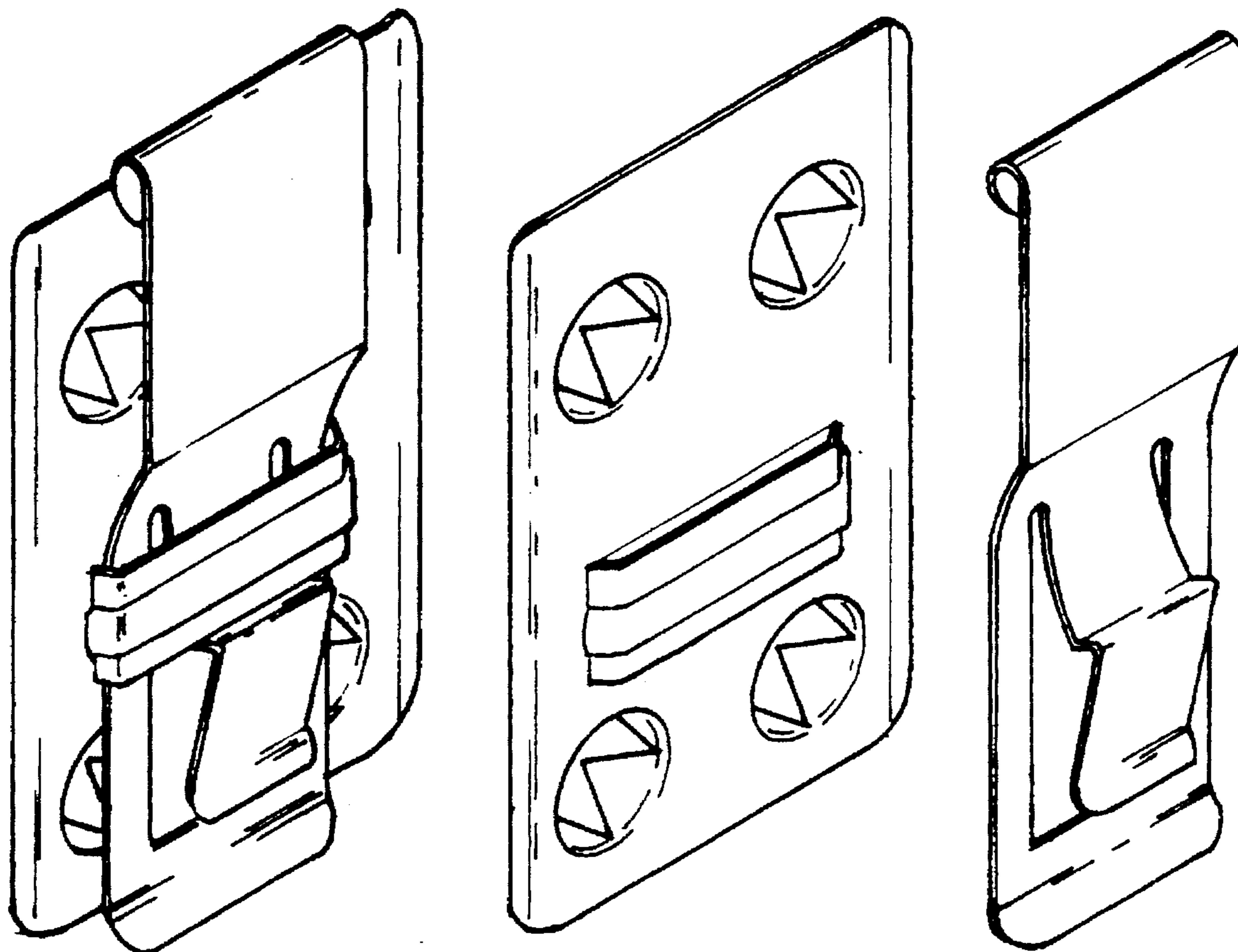

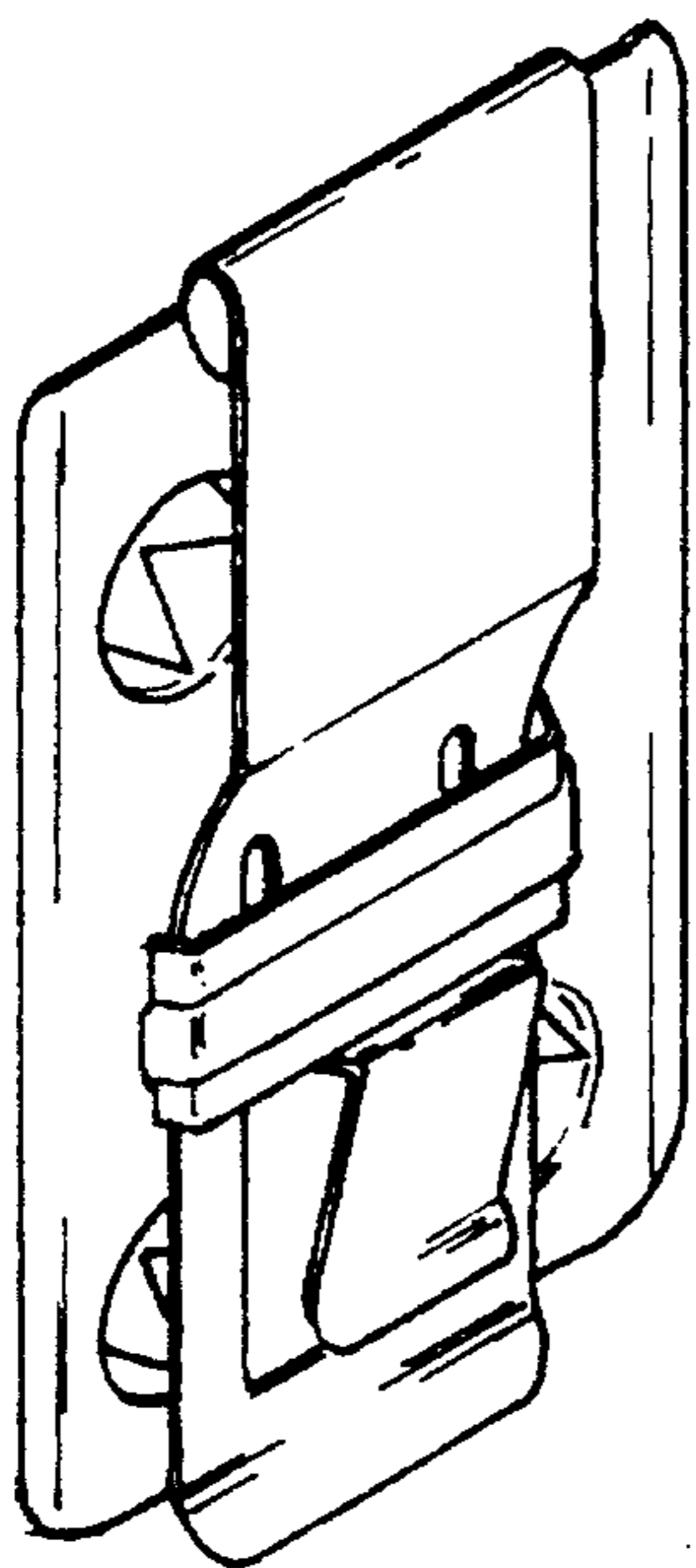

FIG 1

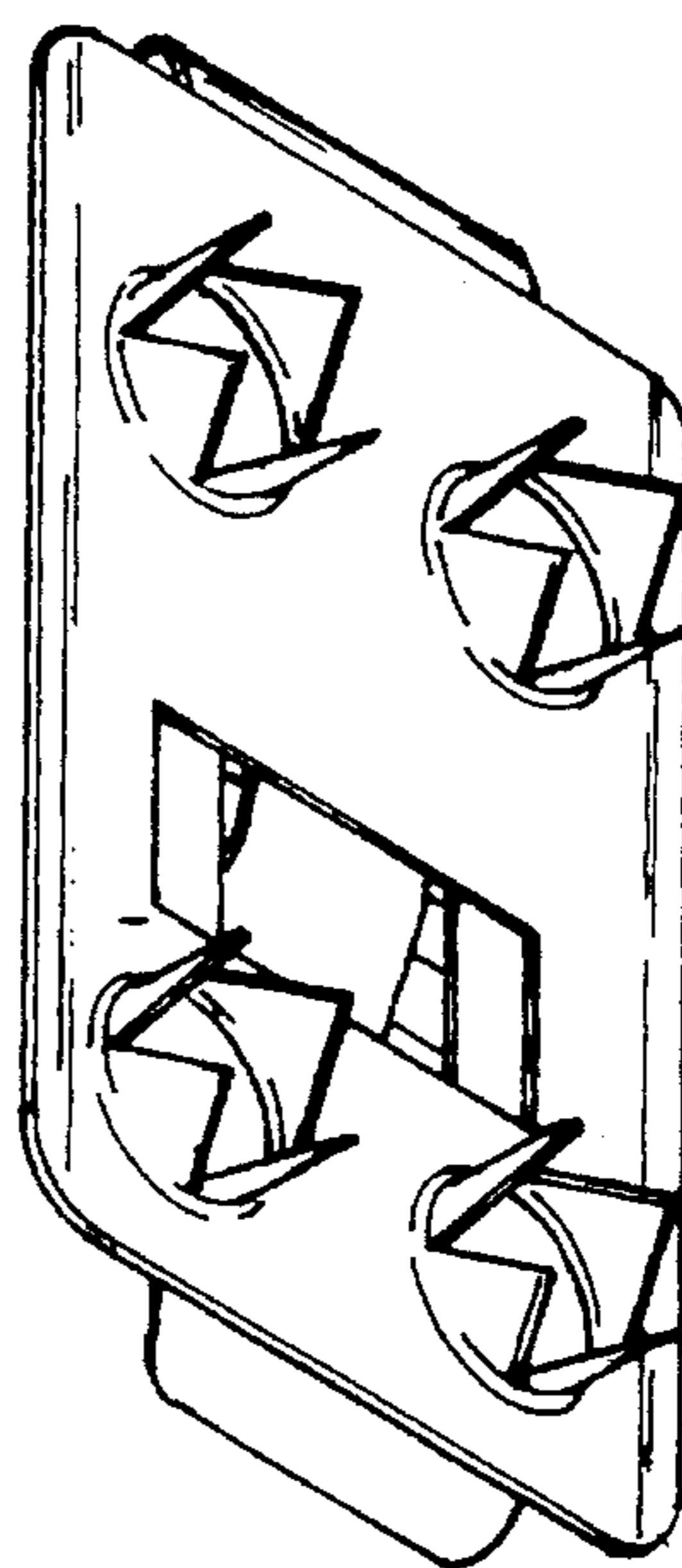

FIG 2

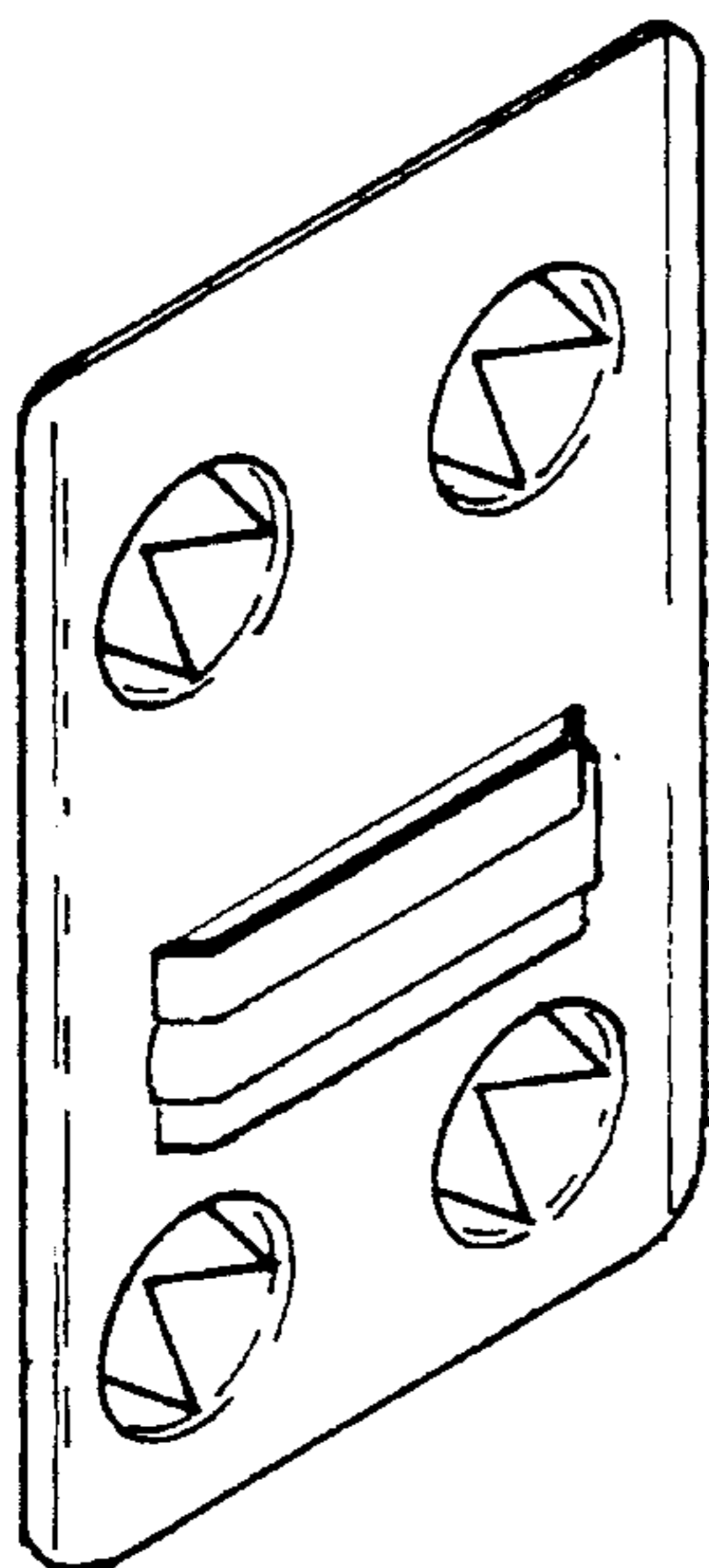

FIG 3

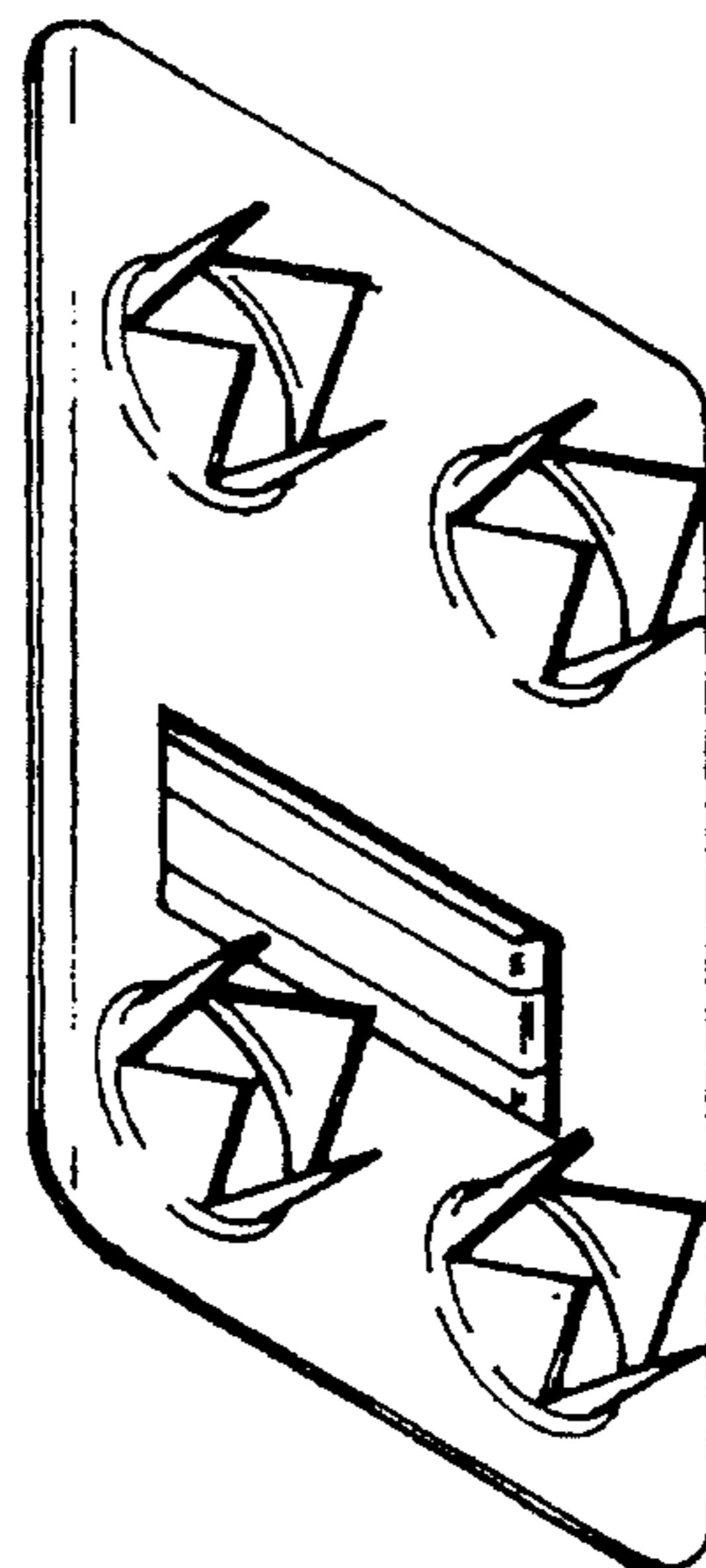

FIG 4

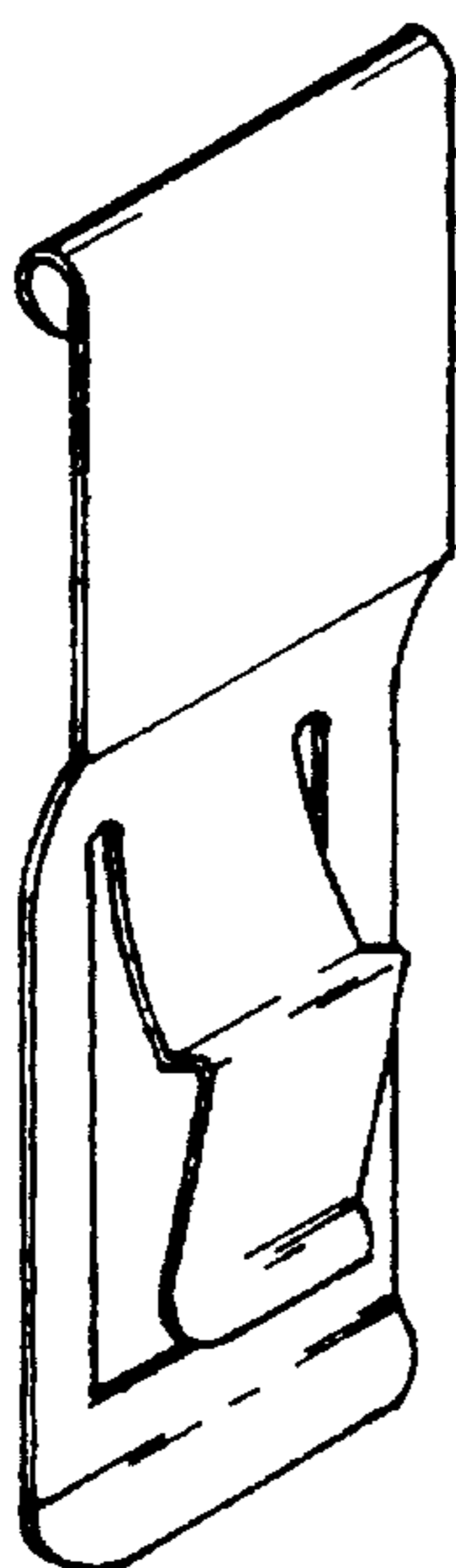

FIG 5

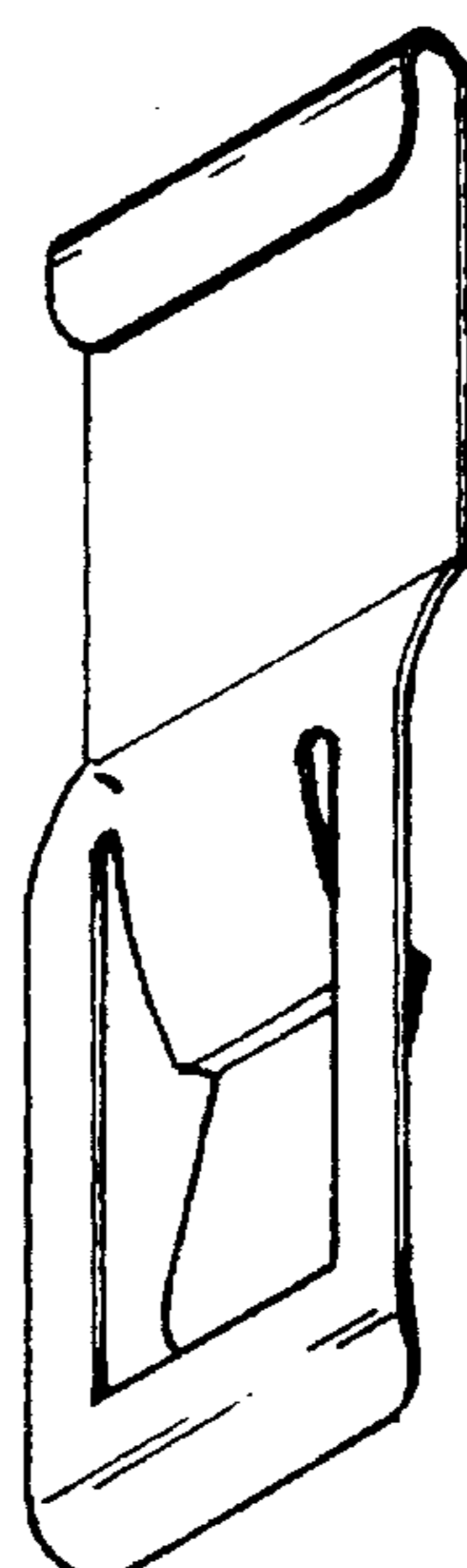

FIG 6